

2025

BLAZER

ATHLETIC EQUIPMENT



ATHLETIC EQUIPMENT

Ball Cart, Racks & Cages 45

Baseball Accessories,
Markers, Field Drags36-37

Batons 24

Carts4, 5, 13

Crossbars 13

Crossbar Lifter 8

Cross Country 26

Discus, Cage, Carriers,
& Rings 15-19

Field Maintenance 28, 37

Football Equipment,
Crash Pad, Accessories & Racks 38

High Jump Pits,
& Standards10-12

Hurdles 3-6

Implement Rack 21

Judging Equipment25-27

Lap Counter & Performance
Indicators 24

Measuring Wheels 23

Medicine Balls 42

Pole Vault Pits, Pole Vault
Standards, Base Paddings,
& Accessories 7-9, 12

Roll-Out Runways 21

Scorebooks 46-47

Shot Puts, Carriers,
& Rings 17-19

Soccer Goals, Nets
& Accessories 44

Spikes & Wrenches 22

Starting Blocks & Carts20-21

Stopwatches 14

Take-Off Boards
& Toe Boards 19

Training Equipment39-43

Volleyball Equipment,
Training & Carts29-35

Wall Padding 27



Blazer is a diversified, world-class corporation, specializing in the design and fabrication of athletic equipment. Founded in 1974, our philosophy has always been about doing quality work for a fair price. This strategy has brought tremendous growth and an ever increasing list of satisfied customers. Providing our customers with the same quality, service and fair prices that have always defined our company, is and will remain our everlasting goal.

We ship via UPS  SHIPPING REGULATIONS & GRAPHICS KEY

UPS enforces according to UPS regulations. Weights are listed as actual product weights. Because of new shipping regulations, there may be a different billable weight on package size and items that will require additional handling according to UPS and FedEx. Please feel free to call for a shipping quote. Products may be drop shipped from the factory at the dealer's request. Shipping costs, pricing, return procedures and terms will be supplied by your local dealer. Freight does not include charges such as lift gate, residential, inside delivery, etc.

 Item not pictured.

AH Additional handling charges apply.

 Made in USA

PRODUCT GUARANTEE

All products are guaranteed against defects in material and workmanship for a period of 1-Year from the date of purchase. 5-Year warranty on volleyball hard goods and also hurdles. 12-Year warranty on pits. 1-Year warranty on balance of the line. Blazer products are not guaranteed against misuse, abuse, accidental damage, or improper care.

PRODUCT WARRANTY

Products will be repaired or replaced at the expense of the manufacturer if determined to be defective in material or workmanship only. This limited warranty is the exclusive warranty of the product and no other warranty including warranty of fitness or merchantability is made or implied. The warranty does not cover products that are manufactured by someone other than

Blazer that are merely resold by Blazer to the customer and the Blazer warranty is limited to products actually manufactured by Blazer.

INSPECT MERCHANDISE UPON RECEIPT

You, the customer are obligated to inspect all merchandise on receipt for damage and shortage. Notations of any shortage or damage to the merchandise or packaging must be made on the delivery receipt before signing it. All claims for defective or damaged work must be made by the customer to the appropriate shipping carrier and to Blazer upon receipt. Failure to do so shall constitute irrevocable acceptance of the work and waiver of any defect, damage or shortage. Claims for damage or loss in transit must be made directly against the carrier.

* Blazer reserves the right to improve, modify, or discontinue any product at any time without prior notice. Due to unstable prices on raw material, all prices listed are subject to change without prior notice. Prices listed are suggested school prices and do not include shipping charges.

ORDER AT (800) 322 ★ 2731 8:00 am to 5:00 pm CST
TOLL FREE FAX (800) 257 ★ 4045 24-Hours a day, EVERYDAY!
WWW.BLAZERATHLETIC.COM

SALES OFFICE : **RETURNS & TECHNICAL ASSISTANCE**

Phone (402) 721★2525 (402) 564★2262 Phone

Fax (402) 721★9024 (402) 564★4065 Fax

1720 West 23rd Street : 5109 26th Street

Fremont, NE 68025 : Columbus, NE 68601



**CHECK US
OUT ON
FACEBOOK**

(Left to Right): Amanda Heiman: AP, Customer Service. Wendy Payeur: Office Manager. Brent Ogle, Kirk Diers: Owners. Jackie Agena: AR, Custom Scorebook Specialist, Customer Service. Paige Kapperman: Sales Manager.



Plastic Replacement Hurdle Board
Double ribbed PVC board only.

1163D \$28.90

Drilled Replacement Hurdle Board for Blazer Base
UPS SHIPPABLE 1.6 LBS.

1163U \$28.90

Undrilled Replacement Hurdle Board
UPS SHIPPABLE 1.6 LBS.

**ASK FOR
A HURDLE
SCREEN
PROOF
TODAY!**

**Select 1 -or- 2 Colors for
Your Hurdle Gate Tubes at
NO ADDITIONAL CHARGE!**

Upright tubing on all hurdles, except the #1090, #1095 and #1100 have a variety of available colors.

Screening also available on reverse side of board.
Contact your local dealer for all the details.



TRACK & FIELD
PGS 4-27

**FIELD
MAINTENANCE**
PGS 28 & 37

VOLLEYBALL
PGS 29-35

**BASEBALL
& SOFTBALL**
PGS 36-37

FOOTBALL
PG 38

TRAINING
PGS 39-43

SOCCER
PG 44

BALL RACKS
PG 45

**SCOREBOOKS
& LINE-UP
CARDS**
PGS 46-47

**QUALITY
USA MADE**



★ ALL BLAZER HURDLES SHIP FULLY ASSEMBLED ★ 5-YEAR WARRANTY ★

A
1138

*One of the
Greatest
Hurdles
Ever Built!*

All hurdles have double ribbed PVC hurdle board for superior strength and durability.

The #1138 features interlocking grooved bases that make stacking a cinch!

#1138 features adjustable weight settings.



MEETS IAAF REGULATIONS

[A] Aluminum College Hurdle

Spring loaded, slide weight adjustments in base. Welded one-piece aluminum base. Exclusive, built-in, interlocking guides for easy stacking. 47" board available for IAAF regulations. (Additional charges may apply.)

1138 29 LBS. FREIGHT ONLY

CONTACT DEALER FOR PRICING

B
1136



[B] Aluminum College Hurdle

With adjustable sliding base weights.

1136 28 LBS. FREIGHT ONLY

CONTACT DEALER FOR PRICING



C
1134

All hurdles have double ribbed PVC hurdle board for superior strength and durability.

[C] High School Elite Aluminum Hurdle

Welded one-piece aluminum base with exclusive, built-in, interlocking guides for easy stacking.



1134 23 LBS. FREIGHT ONLY

Meets IAAF regulations

CONTACT DEALER FOR PRICING

**ALL BLAZER
HURDLES
SHIP FULLY
ASSEMBLED**

★
**WITH
5-YEAR
WARRANTY!**

ALL BLAZER HURDLES MEET H.S. PULLOVER SPECIFICATIONS FOR ALL HEIGHTS AND H.S. FEDERATION RULES. ALL HAVE 5-HEIGHT ADJUSTMENTS 30"-33"-36"-39" AND -42".

Blazer can modify most hurdles on these pages to accommodate 36" lanes. Except for #1140, #1158 and #1178. Give us a call for details.

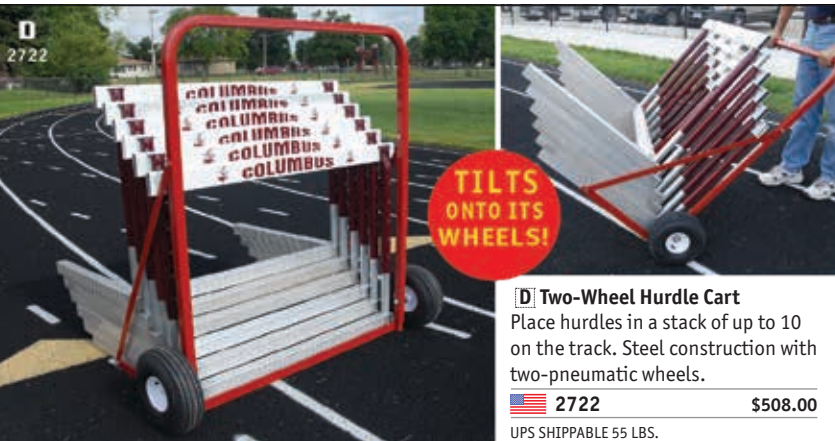

D
2722

**TILTS
ONTO ITS
WHEELS!**

[D] Two-Wheel Hurdle Cart

Place hurdles in a stack of up to 10 on the track. Steel construction with two-pneumatic wheels.

2722 \$508.00

UPS SHIPPABLE 55 LBS.

E
2723



[E] Hurdle Dolly

Steel construction. 4 heavy-duty swivel casters for ease of steering. For open base hurdles.

2723 \$370.00

UPS SHIPPABLE 31 LBS.

HURDLE CART SELECTION CHART

| HURDLE CARTS | 2700 | 2720 | 2722 | 2723 | 2724 |
|---------------------------|-------|-------|-------|-------|-------|
| HURDLES PER CART | | | | | |
| 1134 ★ 1136 ★ 1138 ★ 1140 | 40 EA | 20 EA | 10 EA | 10 EA | 16 EA |
| 1148 ★ 1158 ★ 1168 ★ 1178 | 40 EA | 25 EA | 10 EA | N/A | N/A |



★ ALL BLAZER HURDLES SHIP FULLY ASSEMBLED ★ 5-YEAR WARRANTY ★



F
1137

[F] University Aluminum Hurdle

1137 29 LBS. FREIGHT ONLY **CONTACT DEALER FOR PRICING**
 • Designed for College • Wider profile base
 • Extruded aluminum with beveled edges
 • Spring loaded, slide weight adjustable in base
 47" board available for IAAF regulations



G
1148
1168

[G] High School Rocker Hurdle

1148 25 LBS. FREIGHT ONLY **CONTACT DEALER FOR PRICING**
 Steel base and aluminum upright
1168 21 LBS. FREIGHT ONLY **CONTACT DEALER FOR PRICING**
 All aluminum one-piece base



H
1158
1178

[H] High School Rocker Hurdle With Brace

High School Rocker Hurdle with brace for added stability.
1158 24 LBS. FREIGHT ONLY **CONTACT DEALER FOR PRICING**
 All aluminum one-piece base - With steel brace
1178 29 LBS. FREIGHT ONLY **CONTACT DEALER FOR PRICING**
 Steel base and aluminum upright - With steel brace



I
1140

[I] Steel/Aluminum Open Base High School Rocker Hurdle

Easy carrying. Also works great for plyometric drills.
1140 31 LBS. FREIGHT ONLY **CONTACT DEALER FOR PRICING**



J
2724

[J] "L" Hurdle Cart

Steel construction. Wheels at handle end swivel. Walk in loading for easy stack ability. For open base hurdles. 41" w.

2724 78 LBS. FREIGHT ONLY **\$636.00**



★ HOLDS 20-25 HURDLES! ★

K
2720

[K] Universal Hurdle Cart

Strong steel construction. 8" cushion wheels for easy handling. Wheels at handle end swivel. Walk in loading for easy stack ability. 41" w.

2720 180 LBS. FREIGHT ONLY **\$764.00**

2720 CART CAN BE MODIFIED FOR WIDER BASE ON 1137 HURDLE



Made in USA

★ ALL BLAZER HURDLES SHIP FULLY ASSEMBLED ★ 5-YEAR WARRANTY ★

A
1100



A Steel Practice Hurdle
4-height adjustments, 30"-33"-36"-39". Great practice hurdle. Plastic crossbar, does not meet pullover specs. Available with white gate tubes only.

1100 \$88.00
14 LBS. FREIGHT ONLY

B
1095



B Steel Elementary Adjustable Hurdle
Adjustable, 21"-24"-27" & 30". Plastic board. 41"width. Great learning hurdle. Available with white gate tubes only.

1095 \$94.00
14 LBS. FREIGHT ONLY

C
1090



C Steel Elementary Hurdle
Plastic crossbar. Stands 22"H x 41"W. (regulation width). Great hurdle for the beginner.

1090 \$73.00
10 LBS. FREIGHT ONLY

D
1167



D X-Trainer, Collapsible
Quickly adjusts from 16" to 39"H. Great training hurdle for plyometrics, speed, and agility drills. Inexpensive for beginners or a personal hurdle for yourself. Folds flat for easy transport and storage.

1167 \$52.00
UPS SHIPPABLE 5 LBS.



E
1169

E Form Finder - Self Training Device

Forces the hurdler into correct body position. Keeps hurdlers arm movement in. Makes hurdler bring trail leg under armpit. Self-training allows coach to spend time with other events. Cloth cross-brace is Velcro® attached which breaks away easily upon contact by hurdler. Uprights are steel powder coated.

1169 \$195.00
UPS SHIPPABLE 2-PKGS - 1 @ 21 LBS., 1 @ 12 LBS.

F
1079



F Foam Hurdle Guard
This soft foam guard simply slips over the top of your hurdle gate. Perfect for preventing bruising and building confidence in your hurdler.

1079 \$12.90/ea
UPS SHIPPABLE 1 LBS.

G
1081



G Indoor/Outdoor Foam Hurdle
30", 33", 36" & 39" adjustments. Made of 18-oz. vinyl coated nylon. Double Velcro® strips hold heights in place. The nylon cover is Velcro® attached.

1081 \$230.00
UPS SHIPPABLE 13 LBS.

★ MEETS ALL H.S. FEDERATION ★ NCAA, IAAF RULES & REGULATIONS. ★

TRACK & FIELD

H
1189

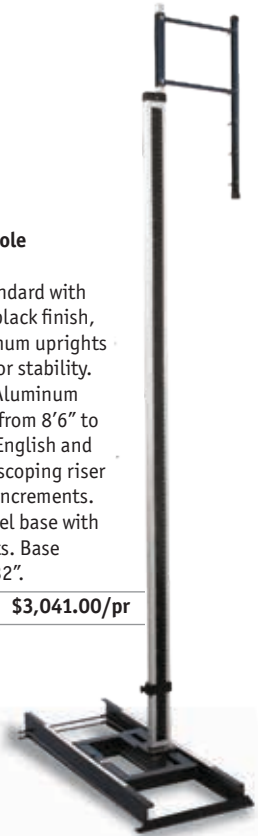

[H] Collegiate Pole Vault Standard
Lightweight standard with powder coated black finish, anodized aluminum uprights and steel base for stability. 2.5"D x 5.5"W. Aluminum uprights adjust from 8'6" to 21'. Heights in English and metric. The telescoping riser is marked in 6" increments. 72"L x 24"W Steel base with anchoring points. Base adjusts from 0-32".

1189 **\$3,041.00/pr**

463 LBS. /PR. 4-BOXES
FREIGHT ONLY

I
1188



[I] Cantabrian International PV Standard
New International/Collegiate design standards offer the ultimate in design and all aluminum lightweight materials. These high quality standards use large diameter aluminum extrusions for uprights to ensure the standards have the rigidity and durability needed for running top quality meets. "Boxed" aluminum designed offset risers with cross-braced welded design gives added crossbar stability. Sleek design aluminum bases adjust from 0-32"/80M. Adjusts from 8'6" to 21' in both standard and metric. Crossbar pins are every 6" for quick easy adjustment of crossbar height.

1188 **\$3,837.00/pr**

305 LBS. /PR. 4-BOXES
FREIGHT ONLY

COLORS MAY VARY

J
1198



[J] Pole Vault Standard Anchor Pins
Pins secure pole vault standards to the ground as required by NFH rule 7-5-11.

1198 **\$35.00**

Sold in sets of 8



K
1190



[K] Aluminum Adjustable Base Vault Standard
All aluminum powder-coated silver for the "new" appearance for years. Upright adjusts from 8'6" to 19' to 1/2" increments. Heights in English & metric. Features easy adjusting base with 32" of movement. Aluminum base is numbered in 1" increments.

1190 **\$2,101.00/pr**

118 LBS. /PR. 3-BOXES
FREIGHT ONLY



L
1195



[L] Steel Adjustable Base Vault Standard
Features the #1190 aluminum upright with the adjustable steel base of the #1183.

1195 **\$1,832.00/pr**

142 LBS. /PR. FREIGHT ONLY

M
1183



[M] Steel Adjustable Base Vault Standard
Features an easy adjusting base with 32" of movement. Base is numbered in 1" increments. Heights are measured in inches. Height adjustments from 5' to 18'. Easily disassembled for storage or base interchanging. Extra bases available.

1183 **\$1,060.00/pr**

144 LBS./PR. - FREIGHT ONLY

A
1560 **[A] Crossbar Lifter**
For faster crossbar positioning.
All steel construction.



1560 **\$36.00**
3 LBS. FREIGHT ONLY

B
1561 **★ SLIDES OVER CROSSBAR ★
OR POLE VAULT!**

[B] Deluxe Crossbar Center Lifter
This all-steel lifter addresses the need for only one person to put up a crossbar.



1561 UPS SHIPPABLE 3 LBS. **\$75.50**

Vault Standard Base Pads
Numbered 0-32 for accurate adjustments. 18-oz. vinyl coated nylon with high density urethane foam padding.



C
1279

[C] Max Pole Vault Standard Base Pads
Only needed with the Sky Flight Max Pits. Fits directly into void of pit.

1279 75 LBS. FREIGHT ONLY **CONTACT DEALER FOR PRICING /PR**
OVERALL SIZE: 60"L X 21"W X 14"H
*PLEASE NOTE COLOR CHOICE BEHIND STOCK # WHEN ORDERING.
SEE LIST BELOW FOR AVAILABLE COLORS.

[Olympic] Olympic Vault Pit Standard Base Pads
Only needed with the Sky-Flight Olympic pit. Fits directly into void of pit.

1196 100 LBS. FREIGHT ONLY **CONTACT DEALER FOR PRICING /PR**
OVERALL SIZE: 66"L X 33"W X 15"H
*PLEASE NOTE COLOR CHOICE BEHIND STOCK # WHEN ORDERING.
SEE LIST BELOW FOR AVAILABLE COLORS.

1189PAD FOR 1189 STANDARD ONLY. **CONTACT DEALER FOR PRICING /PR**
80 LBS. FREIGHT ONLY
*PLEASE NOTE COLOR CHOICE BEHIND STOCK # WHEN ORDERING.
SEE LIST BELOW FOR AVAILABLE COLORS.

AVAILABLE PAD COLORS



Lt. Gold Orange Red Purple Maroon Royal Navy Forest Black Gray

E
1276 **NEW LOWER PRICE!**



[E] Pole Vault Box Collar System
Fits any pole vault landing system. The cover is made of heavy duty vinyl, with polyethylene foam filler tested to meet new ASTM F-2949-12 specification. The system comes with four (4) in ground anchors (included), which limits shifting of landing area. A special hinge system allows the pad to fold in half to ship UPS and for easy storage.

1276 UPS SHIPPABLE 20LBS. + AH **\$699.00**

**★ MEETS ASTM F2949-12 STANDARD TO BE COMPLIANT ★
WITH 2015 NCAA & NFHS RULES!**

[F] PV Extenders
Fits our #1188 and #1189 standards, respectively, as well as similar models and styles. Allows the standards to extend down to 5'6".

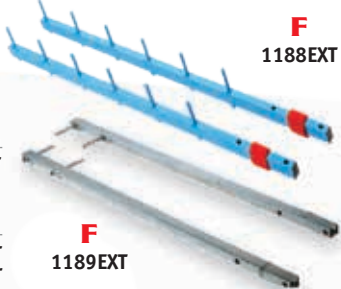

F
1188EXT **\$203.60/pr**
Aluminum ★ Cantabrian International 3' PV Extender
UPS SHIPPABLE 3 LBS./PR.

F
1189EXT **\$228.80/pr**
Steel ★ Collegiate 3' PV Extender
UPS SHIPPABLE 10 LBS./PR.

G
1272



[G] PV Standard Extender
Solid construction, bolts into bottom of arm. Allows standard to extend down to 5 feet.

1272 **\$163.00/pr**
UPS SHIPPABLE 7 LBS./PR. FOR 1190/1195

H
1562 **Improved!**



[H] Pole Vault & High Jump Blaze Laser Staff
Measures with the touch of a button. The staff is extremely quick and accurate. 60" Blaze Laser Measuring Staff with backlit color screen makes it easy to read. Measures from 5 feet on up. Bluetooth Smart/Instantly Transfers Measurements

1562 **\$440.00**
UPS SHIPPABLE 10 LBS. + AH

[I] Aluminum Vault Box (Box only)
Made of 1/8" 11-gauge aluminum construction. Conforms to NCAA and National HS federation recommendations.
Offers a 105-tilt on front.

1286 **\$590.00**
UPS SHIPPABLE 21 LBS.

J
1287



[J] Aluminum Vault Box Lid (Lid only)

1287 **\$287.00**
UPS SHIPPABLE 14 LBS. + AH

K
1290



[K] Steel Vault Box (Box only)
Heavy 12-gauge powder coated steel construction conforms to NCAA and National HS Federation recommendations.

1290 **\$363.00**
UPS SHIPPABLE 41 LBS.

L
1293



[L] Steel Vault Box Lid (Lid only)
Also fits Blazer's #1280 Fiberglass Vault Box.

1293 **\$242.00**
UPS SHIPPABLE 30 LBS. + AH

OFFERS A 105° TILT ON FRONT!

M
1296

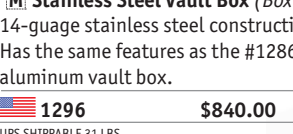

[M] Stainless Steel Vault Box (Box only)
14-gauge stainless steel construction. Has the same features as the #1286 aluminum vault box.

1296 **\$840.00**
UPS SHIPPABLE 31 LBS.

N
1297

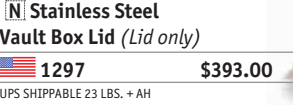

[N] Stainless Steel Vault Box Lid (Lid only)

1297 **\$393.00**
UPS SHIPPABLE 23 LBS. + AH

M
1296

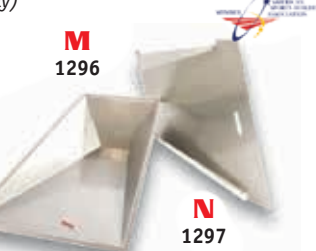

N
1297

★ ALL BLAZER PITS HAVE A ★ 12-YEAR WARRANTY ★



All Blazer Pits comply with the National High School Federation Rules and Regulations!

N Double-Front Pole Vault Pits

Top pad & weather cover included!

Save time and wear and tear on pit! No need to flip front ends due to wind. Available on #1237 and #1274 pit models. Same specifications as the #1237 and #1274 PV Pits. Meets all high school and college specifications. **Olympic & Max Standard Base Pads are sold separately.** (See #1196 & #1279 on pg-8).

1274DF FREIGHT ONLY **CONTACT DEALER FOR PRICING**
OVERALL SIZE: 20'W X 29'L X 32"H

1237DF FREIGHT ONLY **CONTACT DEALER FOR PRICING**
OVERALL SIZE: 22'W X 33'6"L X 32"H

*PLEASE NOTE COLOR CHOICE BEHIND STOCK # WHEN ORDERING.
SEE LIST BELOW FOR AVAILABLE COLORS.



N
1274DF
1237DF



3-Way, D-Ring snaps secure landing pad to pit sections.

O Sky Flight Olympic Pole Vault Pit

Top pad & weather cover included!

Meets all high school and college federation standards. 18 oz. vinyl coated, breathable, nylon. XL 1000 Supreme Prime foam filling. Lattice type internal foam construction. Built-in handles for easy lifting and carrying. Durable lock-rings hold all units securely together. All seams are first under sewn then top stitched. Top pad included. • 4-base units • 2-front units • 2-front extenders. **Olympic Vault Pit Standard Base Pads are sold separately.** (See #1196 on pg-8).

1237 FREIGHT ONLY **CONTACT DEALER FOR PRICING**
OVERALL SIZE: 22'W X 24'L X 32"H

*PLEASE NOTE COLOR CHOICE BEHIND STOCK # WHEN ORDERING.
SEE LIST BELOW FOR AVAILABLE COLORS.

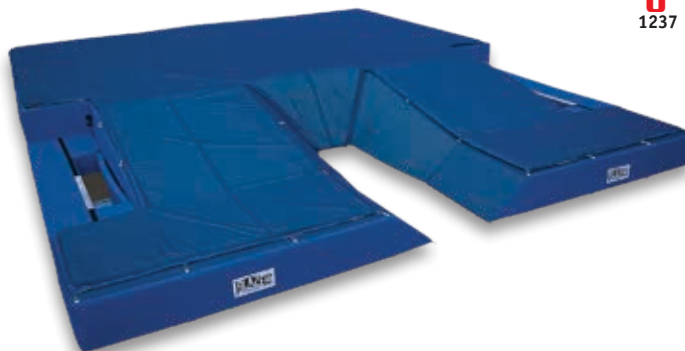

O
1237

P Sky Flight MAX Pit Pole Vault Pit

Top pad & weather cover included!

Meets all high school and college federation standards. Same specs as the #1237. • 4-base units • 2-front units • 2-front extenders. **Max Vault Pit Standard Base Pads are sold separately.** (See #1279 on pg-8).

1274 FREIGHT ONLY **CONTACT DEALER FOR PRICING**
OVERALL SIZE: 20'W X 21'L X 32"H

*PLEASE NOTE COLOR CHOICE BEHIND STOCK # WHEN ORDERING.
SEE LIST BELOW FOR AVAILABLE COLORS.



P
1274



Pole Vault Pit Weather Covers

Weather covers are included with the purchase of a pit.

18-oz. poly vinyl – high UV resistance weather covers. Extends the life of your pit. Snaps to the bottom of the pit. Waterproof except for seams.

Available in Colors: Red, Lt. Gold, Orange, Royal, Navy, Forest, Maroon, Purple, Gray & Black.

1274WC for #1274 PV Pit UPS SHIPPABLE

1237WC for #1237 PV Pit UPS SHIPPABLE

1274DFWC for #1274DF Double-Front PV Pit UPS SHIPPABLE

1237DFWC for #1237DF Double-Front PV Pit UPS SHIPPABLE

CONTACT DEALER FOR PRICING

*PLEASE NOTE COLOR CHOICE BEHIND STOCK # WHEN ORDERING.
SEE LIST BELOW FOR AVAILABLE COLORS.

| PIT COLORS | BASE | | | | | | TOP | | |
|------------|------|----------|--------|-------|------|--------|--------|--------|--|
| | | | | | | | | | |
| | Red | Lt. Gold | Orange | Royal | Navy | Forest | Maroon | Purple | |
| | | | | | | | Gray | Black | |

* PLEASE NOTE COLOR CHOICE BEHIND STOCK # WHEN ORDERING.

★ **ATTENTION!** ★
TO ENSURE EXPANSION OF PITS
OPEN IMMEDIATELY UPON RECEIPT!

A
1212



A Steel Roll Away High Rump Standard
Powder coated uprights. 16" base with wheels. For High School or College. Adjusts from 2' to 8' in 1/4" intervals. Metric scale in cm 62 to 244.

1212 \$740.00/pr
UPS SHIPPABLE 2-PKGS
1@ 23 LBS., 1 @ 38 LBS.

B
1215

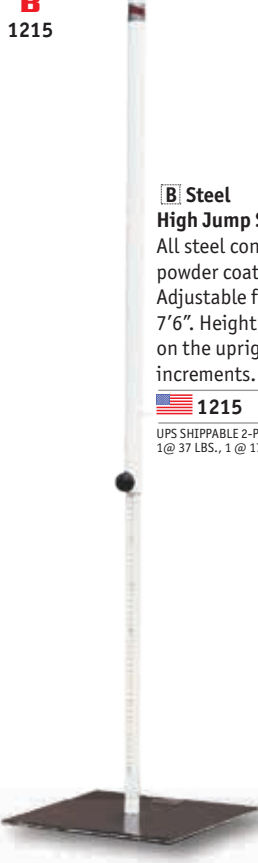

B Steel High Jump Standard
All steel construction, powder coated upright. Adjustable from 12" to 7'6". Height is marked on the upright in 1/2" increments.

1215 \$276.00/pr
UPS SHIPPABLE 2-PKGS
1@ 37 LBS., 1 @ 17 LBS.



C
1202



C Optional Wheel Kit for #1215
Included with both the #1209 and #1211 high jump standards.

1202 \$51.70/pr
UPS SHIPPABLE 5 LBS./PR

D
1213

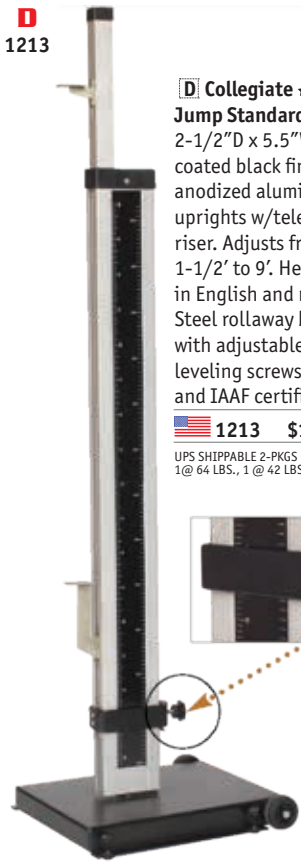

D Collegiate High Jump Standard
2-1/2"D x 5.5"W powder coated black finish with anodized aluminum uprights w/telescoping riser. Adjusts from 1-1/2' to 9'. Heights in English and metric. Steel rollaway base with adjustable leveling screws. NCAA and IAAF certified.

1213 \$1,237.50/pr
UPS SHIPPABLE 2-PKGS
1@ 64 LBS., 1 @ 42 LBS. + AH



E
1209

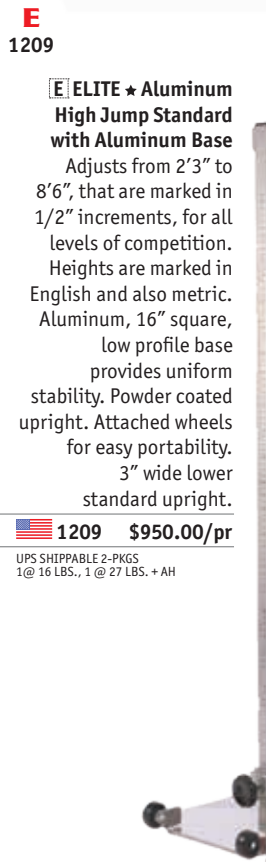

E ELITE Aluminum High Jump Standard with Aluminum Base
Adjusts from 2'3" to 8'6", that are marked in 1/2" increments, for all levels of competition. Heights are marked in English and also metric. Aluminum, 16" square, low profile base provides uniform stability. Powder coated upright. Attached wheels for easy portability. 3" wide lower standard upright.

1209 \$950.00/pr
UPS SHIPPABLE 2-PKGS
1@ 16 LBS., 1 @ 27 LBS. + AH

F
1211



F DELUXE Aluminum High Jump Standard with Steel Base
Adjusts from 2'3" to 8'6", marked in 1/2" increments, for all levels of competition. Heights are marked in English and also metric. Steel, 16" square, low profile base provides uniform stability. Attached wheels for easy portability. 3" wide lower standard upright.

1211 \$870.00/pr
UPS SHIPPABLE 2-PKGS
1@ 39 LBS., 1 @ 27 LBS. + AH

★ ALL BLAZER PITS HAVE A ★ 12 - YEAR WARRANTY ★
Check out the HIGH JUMP PACKAGE DEALS on the next page!

TRACK & FIELD

Super-Flight Olympic High Jump Pit

Top pad & weather cover included!
 The same features as the #1234. Meets all high school and college federation standards.

1240 FREIGHT ONLY **CONTACT DEALER FOR PRICING**

2-Base Units: 5'6"W X 10'L X 26"H & 2-Units: 5'6"W X 11'L X 26"H
 Top Foam Pad: 22"W X 11'L X 2"H
OVERALL SIZE: 22"W X 11'L X 28"H with safety cutout for standards.

*PLEASE NOTE COLOR CHOICE BEHIND STOCK # WHEN ORDERING. SEE LIST BELOW FOR AVAILABLE COLORS.

Pro-Flight High Jump Pit

Top pad & weather cover included!
 Extended front protection. 18-oz. vinyl coated, breathable nylon. XL-1000 Supreme Prime foam filling. Lattice type internal foam construction. Built-in handles for easy lifting and carrying. Durable lock rings hold all units securely together. All seams are first under sewn then top stitched. Meets all high school and college federation standards.

1234 FREIGHT ONLY **CONTACT DEALER FOR PRICING**

2-Base Units: 5'6"W X 9'L X 26"H & 2-Units: 5'6"W X 8'L X 26"H
 Top Foam Pad: 22"W X 9'L X 2"H
OVERALL SIZE: 22"W X 9'L X 28"H with safety cutout for standards.

*PLEASE NOTE COLOR CHOICE BEHIND STOCK # WHEN ORDERING. SEE LIST BELOW FOR AVAILABLE COLORS.

G
1234

Collegiate Flight High Jump Pit

Top pad & weather cover included!
 The same features as the #1232. Meets all high school and college federation standards.

1233 FREIGHT ONLY **CONTACT DEALER FOR PRICING**

3-Base Units: 6"W X 10'L X 26"H.
 Top Foam Pad: 18"W X 10'L X 2"H
OVERALL SIZE: 18"W X 10'L X 28"H

*PLEASE NOTE COLOR CHOICE BEHIND STOCK # WHEN ORDERING. SEE LIST BELOW FOR AVAILABLE COLORS.

Varsity Flight High Jump Pit

Top pad & weather cover included!
 The same features as the #1234. Meets all high school and college federation standards.

1231 FREIGHT ONLY **CONTACT DEALER FOR PRICING**

2-Base Units: 5'10"W X 8'L X 26"H & 1-Unit: 5'10"W X 9'L X 26"H
 Top Foam Pad: 17'6"W X 9'L X 2"H
OVERALL SIZE: 17'6"W X 9'L X 28"H with safety cutout for standards.

*PLEASE NOTE COLOR CHOICE BEHIND STOCK # WHEN ORDERING. SEE LIST BELOW FOR AVAILABLE COLORS.

H
1231

Top Flight High Jump Pit

Top pad & weather cover included!
 18-oz. vinyl coated, breathable nylon. XL-1000 Supreme Prime foam filling. Lattice type internal foam construction. Built-in handles for easy lifting and carrying. Durable lock rings hold all units securely together. All seams are first under sewn then top stitched. Meets all high school and college federation standards.

1232 FREIGHT ONLY **CONTACT DEALER FOR PRICING**

3-Base Units: 5'6"W X 8'L X 26"H
 Top Foam Pad: 16'6"W X 8'L X 2"H
OVERALL SIZE: 16'6"W X 8'L X 28"H

*PLEASE NOTE COLOR CHOICE BEHIND STOCK # WHEN ORDERING. SEE LIST BELOW FOR AVAILABLE COLORS.

I
1232

Fastex buckles ensure a SNUG FIT between landing pit surfaces.

CALL FOR PRICING ON ★ BLAZER ★ WEATHER COVERS!

High Jump Pit Weather Covers

Weather covers are included with the purchase of a pit. 18-oz. poly vinyl – high UV resistance weather covers. Extends the life of your pit. Snaps to the bottom of the pit. Waterproof except for seams.

Available in Colors: Red, Lt. Gold, Orange, Royal, Navy, Forest, Maroon, Purple, Gray & Black.

*PLEASE NOTE COLOR CHOICE BEHIND STOCK # WHEN ORDERING. SEE LIST BELOW FOR AVAILABLE COLORS.

| | |
|--------------------------------|----------------------|
| 1240WC for #1240 HJ Pit | UPS SHIPPABLE 45 LBS |
| 1234WC for #1234 HJ Pit | UPS SHIPPABLE 45 LBS |
| 1233WC for #1233 HJ Pit | UPS SHIPPABLE 35 LBS |
| 1231WC for #1231 HJ Pit | UPS SHIPPABLE 35 LBS |
| 1232WC for #1232 HJ Pit | UPS SHIPPABLE 36 LBS |

CONTACT DEALER FOR PRICING

PIT COLORS

| | | | | | |
|------|--|--|--|--|--|
| BASE | | | | | |
| | | | | | |
| TOP | | | | | |
| | | | | | |

* PLEASE NOTE COLOR CHOICE BEHIND STOCK # WHEN ORDERING.

**★ ATTENTION! ★
 TO ENSURE EXPANSION OF PITS
 OPEN IMMEDIATELY UPON RECEIPT!**

★ ALL BLAZER PITS HAVE A ★ 12 - YEAR WARRANTY ★



A
1240CP



YOUR BEST VALUE!

B
1232CP



CUSTOM PRINTING NOW AVAILABLE

*Simplify the ordering process, improve your entire system and most of all **SAVE MONEY!** Simply by ordering a **VALUE PACKAGE!***

C
12740CP
12741CP



| PIT COLORS | BASE | | | | | | TOP | | |
|------------|--------|----------|--------|-------|-------|--------|-------|-------|--------|
| | Red | lt. Gold | Orange | Royal | Navy | Forest | Red | Royal | Forest |
| | Forest | Maroon | Purple | Gray | Black | Gray | Black | | |

* PLEASE NOTE COLOR CHOICE BEHIND STOCK # WHEN ORDERING.

★ HIGH JUMP ★

HJ Value Package #1

1240CP HIGH JUMP Includes:

- 1240 Super Flight Olympic HJ Pit (22'X11'X28")
- 1240WC Weather Cover
- 1209 Elite High Jump Standards (1-pair)
- 1511 Deluxe Fiberglass Crossbar (1)

CONTACT DEALER FOR PRICING

HJ Value Package #2

1233CP HIGH JUMP Includes:

- 1233 Collegiate Flight HJ Pit (18'X10'X28")
- 1233WC Weather Cover
- 1209 Elite High Jump Standards (1-pair)
- 1511 Deluxe Fiberglass Crossbar (1)

CONTACT DEALER FOR PRICING

HJ Value Package #3

1231CP HIGH JUMP Includes:

- 1231 Varsity Flight High Jump Pit (17'6"X9'X28")
- 1231WC Weather Cover
- 1211 Deluxe High Jump Standards (1-pair)
- 1511 Deluxe Fiberglass Crossbar (1)

CONTACT DEALER FOR PRICING

HJ Value Package #4

1232CP HIGH JUMP Includes:

- 1232 Top Flight High Jump Pit (16'6"X8'X28")
- 1232WC Weather Cover
- 1211 Deluxe High Jump Standards (1-pair)
- 1511 Deluxe Fiberglass Crossbar (1)

CONTACT DEALER FOR PRICING

★ POLE VAULT ★

PV Value Package #1

12370CP POLE VAULT Includes:

- 1237 Sky-Flight Olympic PV Pit (22'X24'X32")
- 1237WC Weather Cover
- 1196 Olympic PV Standard Base Padding
- 1190 Alum. PV Standards w/ Alum Adj Base (1-pair)
- 1512 Deluxe Fiberglass Crossbar (1)

CONTACT DEALER FOR PRICING

PV Value Package #2

12371CP POLE VAULT Includes:

- 1237 Sky-Flight Olympic PV Pit (22'X24'X32")
- 1237WC Weather Cover
- 1196 Olympic PV Standard Base Padding
- 1195 Alum. PV Standards w/ Steel Adj Base (1-pair)
- 1512 Deluxe Fiberglass Crossbar (1)

CONTACT DEALER FOR PRICING

PV Value Package #3

12740CP POLE VAULT Includes:

- 1274 Sky Flight Max PV Pit (20'X21'X32")
- 1274WC Weather Cover
- 1279 Max PV Standard Base Padding (1-pair)
- 1190 Alum. PV Standards w/ Alum Adj Base (1-pair)
- 1512 Deluxe Fiberglass Crossbar (1)

CONTACT DEALER FOR PRICING

PV Value Package #4

12741CP POLE VAULT Includes:

- 1274 Sky Flight Max PV Pit (20'X21'X32")
- 1274WC Weather Cover
- 1279 Max PV Standard Base Padding (1-pair)
- 1195 Alum. PV Standards w/ Steel Adj Base (1-pair)
- 1512 Deluxe Fiberglass Crossbar (1)

CONTACT DEALER FOR PRICING



D
2712, 2714

FRONT AXLE HAS FULL 180° TURNING RADIUS!

D Super Carts, Aluminum Floor - Aluminum Frame

Same features as the wood floor-steel frame pit/hurdle carts. Constructed of tread-plate, rust free aluminum surface and frame. 1000 lb. capacity.

| | | | |
|--|-------------|--|-------------------|
| | 2712 | 4' x 8' 178 LBS. 2-BOXES - FREIGHT ONLY | \$2,017.00 |
| | 2714 | 5' x 10' 234 LBS. 2-BOXES - FREIGHT ONLY | \$2,442.00 |



E
2711, 2713

FRONT AXLE HAS FULL 180° TURNING RADIUS!

E Super Carts, Wood Floor - Steel Frame

Transports all pits, hurdles, standards & MORE! Industrial-grade front axle swivel provides ease in steering. Heavy-duty plywood load surface, recessed in steel frame for protection. 16" fully pneumatic tires for easy pulling on most surfaces. Can be pulled behind a small tractor. 1000 lb. capacity.

| | | | |
|--|-------------|--|-------------------|
| | 2711 | 4' x 8' 211 LBS. 2-BOXES - FREIGHT ONLY | \$1,527.00 |
| | 2713 | 5' x 10' 283 LBS. 2-BOXES - FREIGHT ONLY | \$1,968.00 |



F
2700

F Transport Cart

4' x 8', 17" off the ground. Easily moves up to 40-hurdles, pits, or other heavy equipment. (4) 10" pneumatic wheels, (2) that swivel, (2) that are fixed, provide easy pulling in grass or hard surfaces. Red painted steel construction throughout with a wooden deck. Extends life to pits by reducing wear that occurs while dragging them. 1000 lb. capacity.

| | | |
|--|-------------|-----------------|
| | 2700 | \$942.00 |
|--|-------------|-----------------|

233 LBS. 2-BOXES - FREIGHT ONLY

G Steel Equipment Wagon

Heavy-gauge, steel-mesh bed with fold-down sides. Bolts are welded to the bed for quick assembly. Towable. Pneumatic 13" wheels. Capacity 6.0 cubic feet. Weight limit 1000 lbs. Color may vary.

G
1125



| | | |
|--|-------------|-----------------|
| | 1125 | \$370.00 |
|--|-------------|-----------------|

UPS SHIPPABLE 69 LBS + AH

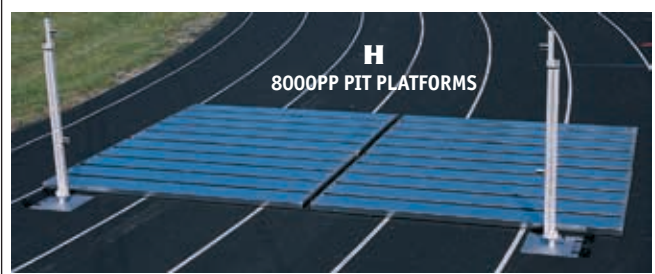

H
8000PP PIT PLATFORMS

H High Jump and Pole Vault Pit Platforms

Constructed of non-corrosive aluminum.

| | | | |
|--|-----------------------------|--------------|-------------------------|
| | 8000PP Pit Platforms | FREIGHT ONLY | \$19.05/pr sq ft |
|--|-----------------------------|--------------|-------------------------|



Sandbags INCLUDED with Pit Cover!

KEEPS SAND IN & DEBRIS OUT!

I
1604
1604V

J
1311

I Pit Covers

Made of 10-oz. vinyl coated polyester mesh. Attached, unfilled weight pouches included.

| | | |
|--|---|----------------------|
| | 1604 Vinyl Coated Mesh Pit Cover | \$4.85/sq ft. |
|--|---|----------------------|

UPS SHIPPABLE

Made of 18-oz. solid polyester vinyl.

| | | |
|--|------------------------------------|----------------------|
| | 1604V Solid Vinyl Pit Cover | \$5.50/sq ft. |
|--|------------------------------------|----------------------|

UPS SHIPPABLE

J Replacement Sandbag

For pit covers #1604. Velcro closure. Sandbag arrives unfilled. 7" x 14".

| | | |
|--|-------------|-------------------|
| | 1311 | \$26.00/ea |
|--|-------------|-------------------|

UPS SHIPPABLE 1 LB.



*PLEASE NOTE COLOR CHOICE BEHIND STOCK # WHEN ORDERING.

K Weather Cover Insert

Extends life of pits. Helps to shed water off the weather cover.



K
1268

| | | | |
|--|-------------|----------------------|----------------|
| | 1268 | UPS SHIPPABLE 14 LBS | \$61.60 |
|--|-------------|----------------------|----------------|

L Deluxe Crossbars

With double matte pultruded construction enables this crossbar to meet the Collegiate, International and High School Federation specs.

OUR FINEST CROSSBAR!

| | | | |
|--|--------------|--|-----------------|
| | 1511 | High Jump-13' 1-1/2" 8 LBS. FREIGHT ONLY | \$121.00 |
| | 15113 | HJ Set of 3 24 LBS. FREIGHT ONLY | \$352.10 |
| | 1512 | Pole Vault-14' 10" 8 LBS. FREIGHT ONLY | \$125.00 |
| | 15123 | PV Set of 3 24 LBS. FREIGHT ONLY | \$363.75 |

Crossbars are not guaranteed against breakage. Please inspect for visible and concealed damage before accepting delivery.

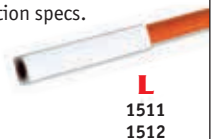

L
1511
1512

M Crossbar Ends

Soft plastic ends that meet NFHS rule 2-6-4 which states that ends of crossbars may not be covered with rubber.

| | | | |
|--|-------------|----------------------------|-------------------|
| | 1530 | for #1501, #1502 Crossbars | \$15.45/ea |
| | 1531 | for #1511, #1502 Crossbars | \$15.45/ea |

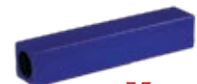

M
1530

N Elastic Foam Crossbar

Bright fluorescent orange color cord for easy visibility with black foam sections.

| | | | |
|--|-------------|---------------------|----------------|
| | 1503 | UPS SHIPPABLE 1 LB. | \$29.00 |
|--|-------------|---------------------|----------------|



N
1503

⚠ **WARNING: Cancer and Reproductive Harm - www.P65Warnings.ca.gov**

★ **EVENT TIMERS** ★

★ **LIGHTNING DETECTOR** ★

A **Ultrak 495**
Stopwatch

4993



- 100-DUAL SPLIT RECALLABLE MEMORY
- MEMORY RECALL DURING OPERATION

100-memory with 3-row display. Take splits during recall mode. Bottom row displays running event time or running lap time. Measures up to ten hours. Stroke frequency. Features time, calendar and alarm. **Water-resistant.**

4993 LITHIUM CR2032 BATTERY **\$62.00**
5-YEAR FACTORY WARRANTY ON WATCH

B **ROBIC 1000W Dual**
Stopwatch/Countdown Timer



4954

The best choice for reliability at the most economical price. Combines a multi-mode Stopwatch with an easy-to-use Countdown Timer. A full 10 hour stopwatch and countdown timer precise to 1/100 second... 20 times more powerful than other brands. Thoughtful design features and high quality construction. Extra large digital, soft rubberized pushbuttons and side grips make the 1000W a pleasure to hold and operate for anyone. Single Event, Lap or Split Timing. Two Finish Time Memory Recall. Unlimited number of time readings can be taken. Countdown timer shows time Remaining; Counts up to completion. Audible alarm at completion of countdown.

4954 LR44 BATTERY **\$23.00**
1-YEAR FACTORY WARRANTY ON WATCH

C **M847 Strike Alert**
HD-Lightning Detector

4955



Graph shows you the lightning strike distance (from 0-40 miles away) as well as a 1-hour storm trend and intensity. Visually see the lightning strike distance and the 1-hour storm trend. 360 Lightning Detection. An audible and/or vibrate warning alerts you before (and while) lightning is within striking distance. LED indicators light accordingly at lightning distances of 24-40 miles, 12-24 miles, 6-12 miles and within 6 miles. Up to 80 hours of operation.

4955 2-AA BATTERIES (included) **\$346.50**
1-YEAR FACTORY WARRANTY ON DETECTOR

★ **COACHES STOPWATCHES & TIMERS** ★

D **Robic SC-429 2**
Mem. Stopwatch

4920



True 3ATM Water Resistant Construction-use it with confidence in any weather. 1/100 second resolution; 24-hour timing range; 2 Memory recall of finish times. A pull tab to prolong life and a Battery Hatch makes battery replacement a breeze. Use a Single Event Stopwatch or take Unlimited Multiple Split Times!

4920 LR 44 BATTERY **\$13.60**
49206 6-COLOR PACK **\$79.40**

COLORS MAY VARY
1-YEAR FACTORY WARRANTY ON WATCH

E **SC-505W**
12-Memory Chrono

4942



- 12-MEMORY CHRONO
 - LAP/SPLIT OR EVENT TIMING
- 12-memory recall. Automatic lap counter to 199. 1/100 second precision to 24-hours. With auto lap-split release. 1st - 12th place finish times. Water-resistant to 30-meters.

4942 LITHIUM CR2032 BATTERY **\$34.55**
49426 SC-505W 6-COLOR PREPACK: **\$203.00**
COLORS MAY VARY

1-YEAR FACTORY WARRANTY ON WATCH

F **Robic SC-757W 500**
Dual Memory Stopwatch

4956



- 500-DUEL MEMORY RECALL, ON DEMAND!

You can recall previous readings without interrupting your current timing • Three (3) line display presents lap, split and accumulated running time. 1/1000 second resolution to 10 hours with a lap counter capacity of 1000 readings • Fastest, slowest and average lap time display, log show time and date of readings • Dual interval repetitive training timer with loop-rep counter-for fitness and training • Countdown timer shows time remaining in any event; set from 1 second to 10 hours • Pacer, Time of Day, Alarm, Calendar • **Water-resistant.**

4956 Lithium CR2032 Battery **\$51.85**
1-YEAR FACTORY WARRANTY ON WATCH & BATTERY

G **Robic SC-899**
Triple Stopwatch

4952



- UP TO 540 MEMORY
- MEMORY RECALL DURING OPERATION

Time 3-competitors at once. Customize your set up with 3-fully loaded time keeping modes: • 1/Chronograph • 2/Speed timer • 3/Countdown timer. Can run simultaneously or separately. Select lap or cum split runnings times. Review each w/o leaving the stopwatch. Recall while timer is running, can immediately take another reading without changing modes. With LED backlight. **Water-resistant and more!**

4952 LITHIUM CR2032 BATTERY **\$77.30**
1-YEAR FACTORY WARRANTY ON WATCH & BATTERY

H **Ultrak-L20 Lane Timer**

4932



Comes with a computer interface, can time track race with up to 20-lanes as well as road races (cross country, 10K's, marathons, etc.) with up to 8,000 participants. Linkgate connects the 20-lane buttons to a separate unit, eliminating tangled wires. Bib numbers can be preassigned to lanes in the trackmode and at the finish for road races. Data can be uploaded to a PC or printed out during or after events for later review. **Includes 2-rolls of thermal paper.**

| | |
|--|---|
| 4936 1-Button Set UPS SHIP 4 LBS. \$673.50 | 4938 8-Button Set UPS SHIP 4 LBS. \$774.20 |
| 4937 6-Button Set UPS SHIP 4 LBS. \$740.15 | 4939 10-Button Set UPS SHIP 4 LBS. \$808.55 |
| 49310WBR 10 Wireless Buttons with Receiver (L10 not included) \$569.95 | |
| 4931 Additional Button \$25.75 | |
| 4931CASE Carrying Case for Ultrak L10 \$50.00 | |
| 4930 Thermal Paper 3-Rolls per box - Each roll 370" long \$30.70 | |

★ DISCUS CAGES ★ 5-YEAR WARRANTY ON POLES!



J
1427
STRAIGHT POSTS



J
1420, 1424
CANTILEVERED POSTS

J Steel ★ Discus Cages

One-piece nylon top cabled net is raised using a “flagpole” design rope system. Quick detach net clips for fast and easy net removal to prevent theft. 12’ or 14’ tall net (with 3-warning signs) provides protection to spectators. Posts drop 9” into PVC pipe ground sleeves which are cemented in. Included weather treated net catches discus preventing ricochet effect. Meets all HS Federation rules. **5-year warranty on poles!**

| | |
|---|-------------------|
| 1427 STRAIGHT Steel Posts with 12’ NET | \$2,530.00 |
| 2.375” O.D. 152 LBS. 7 BOXES - FREIGHT ONLY | |
| 1420 CANTILEVERED Steel Posts with 12’ NET | \$2,334.00 |
| 2.375” O.D. 152 LBS. 7 BOXES - FREIGHT ONLY | |
| 1424 CANTILEVERED Steel Posts with 14’ NET | \$3,889.00 |
| 2.375” O.D. 165 LBS. 7 BOXES - FREIGHT ONLY | |



K
1428

K Elite Aluminum ★ Discus Cage

High quality aluminum poles with 34” rolled offset. Heavy duty solid core poly vinyl ground tubes are used that will not corrode but act as glides for the poles allowing them to slide in easily and resist dirt. The ground sleeve stop bolts and net anchor bolts are stainless steel to resist corrosion. The ground sleeves come with covers to keep the pole and anchor holes clean. Includes a weather treated 58’ x 14’ Net which attaches with carabiners and spring clips for quick removal. Meets all HS federation rules. **5-year warranty on poles!**

| | |
|--|-------------------|
| 1428 CURVED Aluminum Posts with 14’ NET | \$3,718.00 |
| 2.85” O.D. 277 LBS. 2-BUNDLES + 2-BOXES - FREIGHT ONLY | |



L
1432



M
1429

M Elite Aluminum ★ Shot Put Cage

Same quality construction as Discus Cage. Includes a weather treated 43’ x 14’ Net which attaches with carabiners and spring clips for quick removal. Meets all HS federation rules. **5-year warranty on poles!**

| | |
|--|-------------------|
| 1429 CURVED Aluminum Posts with 14’ NET | \$2,940.00 |
| 2.85” O.D. 275 LBS. 2-BUNDLES + 2-BOXES - FREIGHT ONLY | |

N Replacement Cage Nets

Knotless weather treated net (300 lb. breaking strength) “catches” the discus preventing a ricochet effect. One-piece nylon construction. 1 3/4” nylon mesh. Grommets every 24” across top of net. Quick detach net for fast and easy net removal to prevent theft. Can be used with our Straight or Cantilevered Steel Post discus cages. Nets is 58’ long. Meets High School Federation rules.

| | |
|---|-----------------|
| 1431 Replacement net for shot put cage - 43’ X 14’ UPS SHIPPABLE 24 LBS - 1-BOX | \$745.00 |
| 1432 48’ x 7’ Shot Put Cage Barrier Net UPS SHIPPABLE 17 LBS - 1-BOX | \$443.00 |
| 1433 65’ x 7’ Discus Barrier Net UPS SHIPPABLE 22 LBS - 1-BOX | \$578.00 |



O Weather Treated Replacement Net

One-piece nylon top replacement net for discus cages #1427, #1420, #1424, #1428.

| | |
|---|-------------------|
| 1421 Replacement Net - 58’ X 14’ UPS SHIPPABLE 30 LBS | \$1,047.00 |
| 1422 Replacement Net - 58’ X 12’ UPS SHIPPABLE 26 LBS | \$1,016.00 |



**POSITIONABLE NETS ARE EASY TO RAISE & LOWER
★ FOR REMOVAL ON DISCUS CAGES! ★**

A ★ VERY HIGH SPIN ★ TOP THROWERS

88 TO 85% RIM WEIGHTS

When you throw the high % rim weight, it also depends on how the discus is being thrown and how it leaves the hand (spin).

| | | |
|---|---|---|
|  |  |  |
| A GOLD 88% Brass Rim XPT Side Plate Technology | A CANTABRIAN GOLD HYPER - SPIN 85% Brass Rim World leader in Olympic Gold | A BLACK STEALTH 85% Stainless Steel Rim XPT Side Plate Technology |
| 1321 • 1K Women's \$283.80 UPS SHIP 3 LBS. | 1353 • 1K Women's \$363.00 UPS SHIP 3 LBS. | 1324 • 1K Women's \$227.70 UPS SHIP 3 LBS. |
| 1322 • 1.6K Boys \$292.60 UPS SHIP 4 LBS. | 1354 • 1.6K Boys \$396.00 UPS SHIP 4 LBS. | 1325 • 1.6K Boys \$237.60 UPS SHIP 4 LBS. |
| 1323 • 2K College \$306.90 UPS SHIP 5 LBS. | 1355 • 2K College \$418.00 UPS SHIP 5 LBS. | 1326 • 2K College \$260.70 UPS SHIP 5 LBS. |



| DISCUS SELECTION CHART | | |
|--|---------------------------------|-------------------------|
| RECOMMENDED RIM WEIGHT % TO THROWING DISTANCE | | |
| DISCUS RIM WEIGHT | DISCUS THROWING DISTANCE | |
| | HIGH SCHOOL GIRLS | HIGH SCHOOL BOYS |
| 70% - 73% | 100' ★ 125' | 80' ★ 110' |
| 73% - 75% | 120' ★ 150' | 110' ★ 130' |
| 75% - 80% | 140' ★ 160' | 130' ★ 160' |
| 78% - 85% | 150 ★ 165' | 155 ★ 170' |
| 85% - 90% | 160' or more | |
| 85% - 89% | | 165' ★ 180' |
| 90% or more | 175' ★ 200' | |
| 88% or more | | 180' or more |

ALL COMPETITION DISCUS MEET ★ NCAA & NFHS SPECIFICATION! ★

◆ **WARNING: Cancer and Reproductive Harm - www.P65Warnings.ca.gov**

B ★ HIGH SPIN ★ ADVANCED THROWERS

85 TO 80% RIM WEIGHTS

| | | | |
|--|--|---|--|
|  |  |  |  |
| B GALAXY FLIGHT 85% Stainless Steel Rim High Impact ABS Side Plate | B BLAZE 83% Steel Rim High Impact ABS Side Plate | B CANTABRIAN BLACK OLYMPIA 82% Stainless Steel Rim High Impact ABS Side Plate | B LAZER 80% Steel Rim High Impact ABS Side Plate |
| 1316 • 1K Women's \$129.80 UPS SHIP 3 LBS. | 1343 • 1K Women's \$157.25 UPS SHIP 3 LBS. | 1356 • 1K Women's \$265.10 UPS SHIP 3 LBS. | 1351 • 1K Women's \$106.70 UPS SHIP 3 LBS. |
| 1315 • 1.6K Boys \$174.05 UPS SHIP 4 LBS. | 1344 • 1.6K Boys \$161.75 UPS SHIP 4 LBS. | 1357 • 1.6K Boys \$278.35 UPS SHIP 4 LBS. | 1350 • 1.6K Boys \$123.50 UPS SHIP 4 LBS. |
| 1317 • 2K College \$170.40 UPS SHIP 5 LBS. | 1345 • 2K College \$170.50 UPS SHIP 5 LBS. | 1358 • 2K College \$293.70 UPS SHIP 5 LBS. | 1352 • 2K College \$149.65 UPS SHIP 5 LBS. |

C ★ MEDIUM SPIN ★ INTERMEDIATE THROWERS

80 TO 75% RIM WEIGHTS

| | | |
|---|--|---|
|  |  |  |
| C PRESTIGE 80% Galvanized Steel Rim High Impact ABS Side Plate | C CANTABRIAN RED INTERNATIONAL 75% Galvanized Steel Rim High Impact ABS Side Plate | C TARGET 75% Galvanized Steel Rim High Impact ABS Side Plate |
| 1365 • 1K Women's \$66.05 UPS SHIP 3 LBS. | 1359 • 1K Women's \$118.80 UPS SHIP 3 LBS. | 1332 • 1K Women's \$50.60 UPS SHIP 3 LBS. |
| 1366 • 1.6K Boys \$78.10 UPS SHIP 4 LBS. | 1360 • 1.6K Boys \$132.00 UPS SHIP 4 LBS. | 1331 • 1.6K Boys \$62.70 UPS SHIP 4 LBS. |
| | 1361 • 2K College \$148.50 UPS SHIP 5 LBS. | 1333 • 2K College \$77.70 UPS SHIP 5 LBS. |

D ★ LOW SPIN ★ BEGINNING THROWERS





70% & LOWER RIM WEIGHTS CENTER WEIGHTED

| | | | | | | | | | | | | | | | | | | | | | | | | | |
|--|--------------------------------------|---------|-------------------------------------|---------|--------------------------------------|---------|--|--------------------------------------|---------|-------------------------------------|----------|--------------------------------------|----------|---|--------------------------------------|---------|-------------------------------------|---------|--|--------------------------------------|---------|-------------------------------------|---------|--------------------------------------|---------|
|  <p>D LAMINATE WOOD 70% Galvanized Steel Rim Waterproof Laminated Wood Plate</p> <p>BEST BUY!</p> <table border="1"> <tr> <td>1341 • 1K Women's UPS SHIP 3 LBS.</td> <td>\$42.00</td> </tr> <tr> <td>1340 • 1.6K Boys UPS SHIP 4 LBS.</td> <td>\$49.00</td> </tr> <tr> <td>1342 • 2K College UPS SHIP 5 LBS.</td> <td>\$54.00</td> </tr> </table> | 1341 • 1K Women's UPS SHIP 3 LBS. | \$42.00 | 1340 • 1.6K Boys UPS SHIP 4 LBS. | \$49.00 | 1342 • 2K College UPS SHIP 5 LBS. | \$54.00 |  <p>D CANTABRIAN BLUE CHALLENGER 65 to 70% Steel Rim Heavy Duty ABS Side Plate</p> <table border="1"> <tr> <td>1362 • 1K Women's UPS SHIP 3 LBS.</td> <td>\$90.20</td> </tr> <tr> <td>1363 • 1.6K Boys UPS SHIP 4 LBS.</td> <td>\$100.10</td> </tr> <tr> <td>1364 • 2K College UPS SHIP 5 LBS.</td> <td>\$122.10</td> </tr> </table> | 1362 • 1K Women's UPS SHIP 3 LBS. | \$90.20 | 1363 • 1.6K Boys UPS SHIP 4 LBS. | \$100.10 | 1364 • 2K College UPS SHIP 5 LBS. | \$122.10 |  <p>D CORE DISCUS 65 to 70% Galvanized Steel Rim High Impact ABS Side Plate</p> <table border="1"> <tr> <td>1376 • 1K Women's UPS SHIP 3 LBS.</td> <td>\$45.45</td> </tr> <tr> <td>1377 • 1.6K Boys UPS SHIP 4 LBS.</td> <td>\$60.75</td> </tr> </table> | 1376 • 1K Women's UPS SHIP 3 LBS. | \$45.45 | 1377 • 1.6K Boys UPS SHIP 4 LBS. | \$60.75 |  <p>D RUBBER ONE PIECE CONSTRUCTION Official Size and Weight</p> <table border="1"> <tr> <td>1338 • 1K Women's UPS SHIP 3 LBS.</td> <td>\$18.00</td> </tr> <tr> <td>1337 • 1.6K Boys UPS SHIP 4 LBS.</td> <td>\$20.00</td> </tr> <tr> <td>1339 • 2K College UPS SHIP 5 LBS.</td> <td>\$24.00</td> </tr> </table> | 1338 • 1K Women's UPS SHIP 3 LBS. | \$18.00 | 1337 • 1.6K Boys UPS SHIP 4 LBS. | \$20.00 | 1339 • 2K College UPS SHIP 5 LBS. | \$24.00 |
| 1341 • 1K Women's UPS SHIP 3 LBS. | \$42.00 | | | | | | | | | | | | | | | | | | | | | | | | |
| 1340 • 1.6K Boys UPS SHIP 4 LBS. | \$49.00 | | | | | | | | | | | | | | | | | | | | | | | | |
| 1342 • 2K College UPS SHIP 5 LBS. | \$54.00 | | | | | | | | | | | | | | | | | | | | | | | | |
| 1362 • 1K Women's UPS SHIP 3 LBS. | \$90.20 | | | | | | | | | | | | | | | | | | | | | | | | |
| 1363 • 1.6K Boys UPS SHIP 4 LBS. | \$100.10 | | | | | | | | | | | | | | | | | | | | | | | | |
| 1364 • 2K College UPS SHIP 5 LBS. | \$122.10 | | | | | | | | | | | | | | | | | | | | | | | | |
| 1376 • 1K Women's UPS SHIP 3 LBS. | \$45.45 | | | | | | | | | | | | | | | | | | | | | | | | |
| 1377 • 1.6K Boys UPS SHIP 4 LBS. | \$60.75 | | | | | | | | | | | | | | | | | | | | | | | | |
| 1338 • 1K Women's UPS SHIP 3 LBS. | \$18.00 | | | | | | | | | | | | | | | | | | | | | | | | |
| 1337 • 1.6K Boys UPS SHIP 4 LBS. | \$20.00 | | | | | | | | | | | | | | | | | | | | | | | | |
| 1339 • 2K College UPS SHIP 5 LBS. | \$24.00 | | | | | | | | | | | | | | | | | | | | | | | | |

E ★ INDOOR ★ TRAINING DISCUS

| | | | | | | | | | | | | | | | | | | |
|---|--------------------------------------|---------|-------------------------------------|---------|--------------------------------------|---------|---|--------------------------------------|---------|-------------------------------------|---------|--------------------------------------|---------|---|--------------------------------------|--------|-------------------------------------|---------|
|  <p>E INDOOR RUBBER DISCUS Official Non-Marring</p> <table border="1"> <tr> <td>1411 • 1K Women's UPS SHIP 3 LBS.</td> <td>\$28.60</td> </tr> <tr> <td>1412 • 1.6K Boys UPS SHIP 4 LBS.</td> <td>\$33.00</td> </tr> <tr> <td>1413 • 2K College UPS SHIP 5 LBS.</td> <td>\$41.80</td> </tr> </table> | 1411 • 1K Women's UPS SHIP 3 LBS. | \$28.60 | 1412 • 1.6K Boys UPS SHIP 4 LBS. | \$33.00 | 1413 • 2K College UPS SHIP 5 LBS. | \$41.80 |  <p>E RUBBER DISCUS W/ADJUSTABLE STRAP Great for Practice Turns</p> <p>DOES NOT MEET HIGH SCHOOL SPECIFICATIONS</p> <table border="1"> <tr> <td>1307 • 1K Women's UPS SHIP 3 LBS.</td> <td>\$32.45</td> </tr> <tr> <td>1308 • 1.6K Boys UPS SHIP 4 LBS.</td> <td>\$37.25</td> </tr> <tr> <td>1309 • 2K College UPS SHIP 5 LBS.</td> <td>\$40.85</td> </tr> </table> | 1307 • 1K Women's UPS SHIP 3 LBS. | \$32.45 | 1308 • 1.6K Boys UPS SHIP 4 LBS. | \$37.25 | 1309 • 2K College UPS SHIP 5 LBS. | \$40.85 |  <p>E PRACTICE RUBBER DISCUS One Piece Construction</p> <table border="1"> <tr> <td>1306 • 1K Women's UPS SHIP 3 LBS.</td> <td>\$9.60</td> </tr> <tr> <td>1305 • 1.6K Boys UPS SHIP 4 LBS.</td> <td>\$14.45</td> </tr> </table> | 1306 • 1K Women's UPS SHIP 3 LBS. | \$9.60 | 1305 • 1.6K Boys UPS SHIP 4 LBS. | \$14.45 |
| 1411 • 1K Women's UPS SHIP 3 LBS. | \$28.60 | | | | | | | | | | | | | | | | | |
| 1412 • 1.6K Boys UPS SHIP 4 LBS. | \$33.00 | | | | | | | | | | | | | | | | | |
| 1413 • 2K College UPS SHIP 5 LBS. | \$41.80 | | | | | | | | | | | | | | | | | |
| 1307 • 1K Women's UPS SHIP 3 LBS. | \$32.45 | | | | | | | | | | | | | | | | | |
| 1308 • 1.6K Boys UPS SHIP 4 LBS. | \$37.25 | | | | | | | | | | | | | | | | | |
| 1309 • 2K College UPS SHIP 5 LBS. | \$40.85 | | | | | | | | | | | | | | | | | |
| 1306 • 1K Women's UPS SHIP 3 LBS. | \$9.60 | | | | | | | | | | | | | | | | | |
| 1305 • 1.6K Boys UPS SHIP 4 LBS. | \$14.45 | | | | | | | | | | | | | | | | | |

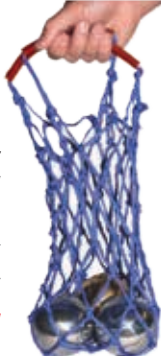
★ DISCUS & SHOT PUT ★ CARRIERS ★ DISCUS RING

| | | |
|--|---|--|
| <p>F 2150</p>  <p>F Discus/Shot Carrier Reinforced nylon bag with sturdy handle. Holds 2-shots or 2-discus.</p> <p>2150 • UPS SHIPPABLE 1 LB. Color May Vary</p> <p>\$15.60</p> | <p>G 2155</p>  <p>G Discus/Shot Carrier with Shoulder Strap The 2150 carrier with strap for extra convenience.</p> <p>2155 • UPS SHIPPABLE 1 LB. Color May Vary</p> <p>\$19.85</p> | <p>H 2156</p>  <p>H Two-Shot Bag Heavy vinyl bag holds 2-shots. Carrying handle plus removable shoulder strap. Snap closure plus side zipper. Color may vary.</p> <p>2156 • UPS SHIPPABLE 2 LBS. Color May Vary</p> <p>\$24.55</p> |
| <p>I 2157</p>  <p>I Multi Shot/Discus Carrier Constructed from heavy nylon netting. Holds multiple shot and discus.</p> <p>2157 • UPS SHIPPABLE 1 LB. Color May Vary</p> <p>\$15.60</p> | <p>J 2120</p>  <p>J Mesh Shot Put Carrier Constructed from heavy, woven polyethylene rope.</p> <p>2120 • UPS SHIPPABLE 1 LB. Color May Vary</p> <p>\$9.95</p> | <p>K 1256</p>  <p>K Discus Trainer The perfect answer for coaches training the spin technique with shot put or discus. This training device is durable, but lightweight and easy to move around. Athletes can use it solo and it is designed so they can get a lot of reps without the coach having to be present at all times. It is adjustable to any athlete. The Sweeper is a great tool for any skill level. It is currently used at the collegiate level, as well as high school and middle school.</p> <p>1256 UPS SHIPPABLE 10 LBS.</p> <p>\$265.00</p> |

⚠ **WARNING: Cancer and Reproductive Harm - www.P65Warnings.ca.gov**

★ SAVE MONEY WHEN YOU PURCHASE THE COMPLETE KIT IN 1-EASY STEP! ★

A **Stainless Steel Shot**
Precision manufactured to the highest standards. Machine turned at a max. ovalization of 0.5 mm and weight tolerance of +25 grams. Unsurpassed quality. UPS shippable. IAAF certified.



| | | |
|--------|-----------------|----------|
| 2114 • | 4K (95mm) | \$162.05 |
| 2112 • | 12 lbs. (103mm) | \$180.70 |
| 2116 • | 16 lbs. (110mm) | \$215.60 |

B **Brass Shot**
Blazer's Olympian brass shot is lathe turned to minimum diameter allowed in competition. Machine finish gives an excellent grip. Unsurpassed quality. UPS shippable.



| | | |
|--------|-----------------|----------|
| 2004 • | 4K (95mm) | \$185.00 |
| 2012 • | 12 lbs. (103mm) | \$202.00 |
| 2016 • | 16 lbs. (110mm) | \$224.00 |

C **Iron Shot**
No indentations or abrasions, cast, not completely smooth. UPS shippable.



| | | |
|--------|--------------------------|---------|
| 1932 • | 2K | \$28.35 |
| 1940 • | Women's 4K (102mm) | \$34.00 |
| 1950 • | Elementary 6 lbs. (92mm) | \$25.00 |
| 1960 • | 8 lbs. (98mm) | \$29.00 |
| 1970 • | 10 lbs. (106mm) | \$36.00 |
| 1980 • | Boy's 12 lbs. (114mm) | \$42.00 |
| 1990 • | College 16 lbs. (125mm) | \$59.00 |
| 1988 • | College 18 lbs. (132mm) | \$60.00 |
| 1989 • | College 20 lbs. (137mm) | \$63.00 |

D **Competition Turned Steel Shot**
High quality turned steel shot. Machine turned with maximum ovalization 0.5 mm and weight tolerance of +25 grams. Surface painted. UPS shippable.



| | | |
|--------|---|----------|
| 2215 • | Women's 4K (104mm) Colors may vary | \$150.00 |
| 2213 • | Boy's 12 lbs. (117mm) Colors may vary | \$160.00 |
| 2217 • | College 16 lbs. (129mm) Colors may vary | \$165.50 |

YOUR BEST BUY!
★ SHOT PUT VALUE PACKAGES ★

E BOY'S INCLUDE:
1992 12 LB. Turned Iron Shot Put
1980 12 LB. Cast Iron Shot Put
1920 12 LB. Indoor Shot Put
2157 Multi-Shot/Discus Carrier
1372 • \$260.00
UPS SHIPPABLE 38 LBS.

F WOMEN'S INCLUDE:
1991 4K Turned Iron Shot Put
1940 4K Cast Iron Shot Put
1910 4K Indoor Shot Put
2157 Multi-Shot/Discus Carrier
1373 • \$242.50
UPS SHIPPABLE 29 LBS.

★ IMPLEMENT VALUE PACKAGES ★

G BOY'S INCLUDE:
1337 Boys Rubber Discus
1340 Boys Laminate Discus
1350 Boys Lazer Discus
1980 Boys Iron Shot
2213 Boys Turned Steel Shot
2155 Shot/Discus Bag w/Shoulder Strap (2)
1370 • \$420.88
UPS SHIPPABLE 41 LBS.

H WOMEN'S INCLUDE:
1338 Women's Rubber Discus
1341 Women's Laminate Discus
1351 Women's Lazer Discus
1940 Women's Iron Shot
2215 Women's Turned Steel Shot
2155 Shot/Discus Bag w/Shoulder Strap (2)
1371 • \$378.60
UPS SHIPPABLE 30 LBS.

★ DISCUS VALUE PACKAGES ★

I BOY'S INCLUDE:
1340 1.6K Laminated Wood Discus
1331 1.6K Target Discus
1412 1.6K Indoor Discus
2155 Shot/Discus Bag w/Shoulder Strap
1374 • \$159.60
UPS SHIPPABLE 12 LBS.

J WOMEN'S INCLUDE:
1341 1K Laminated Wood Discus
1332 1K Target Discus
1411 1K Indoor Discus
2155 Shot/Discus Bag w/Shoulder Strap
1375 • \$136.80
UPS SHIPPABLE 9 LBS.

K Turned Iron Shot
Precision machine turned. Turned Iron Shot is *perfectly balanced*. Weight plus .05 grams. UPS shippable.



| | | |
|--------|-------------------------|---------|
| 1991 • | Women's 4K (109mm) | \$74.00 |
| 1992 • | Boy's 12 lbs. (115mm) | \$87.00 |
| 1993 • | College 16 lbs. (128mm) | \$90.00 |

L Indoor Shot
Hard shell gives the feel of an outdoor shot, but soft enough to not mark or damage gym floors. Neon red/orange color gives high visibility in indoor environments. Calibrated to correctweight. **Guaranteed against breakage for one season.** UPS shippable.



| | | |
|--------|---|----------|
| 1890 • | Elementary Girls, Jr. High 6 lbs. (101mm) | \$105.00 |
| 1900 • | 8 lbs. (114mm) | \$108.00 |
| 1902 • | 2K (101mm) | \$102.00 |
| 1903 • | 3K (114mm) | \$108.00 |
| 1905 • | 5K (127mm) | \$127.00 |
| 1906 • | 6K (139mm) | \$141.00 |
| 1910 • | Women's 4K (114mm) | \$127.00 |
| 1914 • | 14 lbs. (139mm) | \$108.00 |
| 1920 • | Boy's 12 lbs. (127mm) | \$127.00 |
| 1921 • | 10 lbs. (127mm) | \$142.00 |
| 1930 • | College 16 lbs. (139mm) | \$165.00 |

M Soft Shell Indoor Shot
Soft outer shell is ideal for indoor wood gym surfaces. Will not mark or damage gym surface. Calibrated to correct weight. **Guaranteed against breakage for one season.** UPS shippable.



| | | |
|--------|---|----------|
| 1885 • | Elementary Girls, Jr. High 6 lbs. (101mm) | \$104.00 |
| 1886 • | 8 lbs. (114mm) | \$108.00 |
| 1887 • | Womens 2K (114mm) | \$108.00 |
| 1888 • | Boys 12 lbs. (127mm) | \$123.00 |
| 1889 • | College 16 lbs. (139mm) | \$164.00 |

◆  **WARNING: Cancer and Reproductive Harm - www.P65Warnings.ca.gov**















★ TAKE-OFF BOARDS ★

| | |
|---|--|
| <p>N 1248</p>  <p>N Long Jump Take-Off Board 8" Wide Manufactured from laminated wood. Sealed, primed, and finished with a white enamel paint. For high school and collegiate use. Meets rule book specifications. 2-1/2" x 8" x 48".</p> <p> 1248 UPS SHIPPABLE 23 LBS. \$266.00</p> | <p>O 1242</p>  <p>O Long Jump Take-Off Board 20" wide Manufactured from marine grade plywood to meet high school rules. Sealed, primed, and finished with a white enamel paint. 2-3/4" x 20" x 48".</p> <p> 1242 \$220.00 UPS SHIPPABLE 31 LBS.</p> |
|---|--|

★ LONG JUMP TRAYS ★

| | | |
|--|--|--|
| <p>P 1249</p>  <p>P Stainless Steel Long Jump Tray with 8" Board Designed to work with our #1248 board (included). 16-gauge stainless steel with 1" square-tubing frame. Board must be removed when not in use. 6-leveling bolts provided to level board with runway. Drain holes for easy water drainage.</p> <p> 1249 UPS SHIPPABLE 53 LBS. \$509.00</p> | <p>Q 1243</p>  <p>Q Stainless Steel Long Jump Tray with 20" Board Consists of a 20" stainless steel tray with drain holes. Board must be removed when not in use. Includes #1242 20" board.</p> <p> 1243 UPS SHIPPABLE 54 LBS. \$573.00</p> | <p>R 1244 1247</p>  <p>R Stainless Steel Long Jump Tray with Lid and Indicator Board Model #1248 laminated wood board with 4" wide indicator board. 16-gauge stainless steel with 1" square-tubing frame. 6-leveling bolts provided to level board with runway. Indicator board is for plasticine application. Boards must be removed when not in use. Indicator board identifies faults. 12-gauge steel lid is provided to be placed in tray when boards are removed for storage.</p> <p> 1244 Without Lid UPS SHIPPABLE 57 LBS. \$665.00  1247 Without Lid (Pictured) UPS SHIPPABLE 79 LBS. \$736.00</p> |
|--|--|--|

★ TOE BOARDS & RINGS ★

| | | |
|--|--|---|
| <p>S 1253</p>  <p>S Metal Toe Board Will not warp, split, or deteriorate in weather. Radiating lines speed up accurate measurement.</p> <p> 1253 UPS SHIPPABLE 25 LBS. \$276.00</p> | <p>T 1250</p>  <p>T Toe Board Shaped to meet official rules. Weather-resistant and colorfast.</p> <p> 1250 Fiberglass UPS SHIPPABLE 10 LBS. \$325.00</p> | <p>U 1245</p>  <p>U Rigid Polyurethane Toe Board Cross-linked interior design for extreme strength. Waterproof and UV protected.</p> <p> 1245 UPS SHIPPABLE 13 LBS. \$425.75</p> |
| <p>V 1252</p>  <p>V Aluminum Toe Board Cast aluminum construction for long lasting durability. Recessed for ring. Meets all rule specifications.</p> <p> 1252 UPS SHIPPABLE 27 LBS. \$690.00</p> | <p>W 1265</p>  <p>W Shot Put Ring Uses 1" x 3/4" x 1/4" aluminum angle. Holes are provided for anchoring. Meets IAAF, NCAA® and NFHS rules</p> <p> 1265 7' Diameter \$270.00 UPS SHIPPABLE 11 LBS. + AH, 3- SECTIONS (Toe board ordered separately).</p> | <p>X 1255</p>  <p>X Discus Ring Uses 1" x 3/4" x 1/4" aluminum angle. Holes are provided for anchoring. Meets IAAF, NCAA® and NFHS rules</p> <p> 1255 8' x 2-1/2" Diameter \$270.00 UPS SHIPPABLE 14 LBS. + AH, 4- SECTIONS</p> |
| <p>  1266 Hammer Ring 7' Diameter \$270.00 UPS SHIPPABLE 13 LBS. + AH, 4- SECTIONS</p> | | |

A
1119

★ USED BY THE UNIVERSITY OF NEBRASKA! ★

THE CHOICE OF COLLEGIATE SPRINTERS!



[A] University Starting Block
4" wide heavy stainless steel rail (rust proof) and spike plates, with angled spikes that provide a solid grip on the track. The aluminum shoes are 7-3/4" x 6-1/2" with heavy-duty rubber pads and 4-different angle adjustments. Meets IAAS, NCAA & NFHA Rules.



 **1119** UPS SHIPPABLE 32 LBS. **\$478.00**

B
1120



[B] Basic All-Surface Starting Block
Heavy gauge steel construction. Optional heavy-duty pins for installation on dirt surfaces (sold separately). Insert the included spikes in the 14-tapped holes for optimum anchoring. 36" long, longer than most, for easy adaptation to the tall or short runner without being moved. Powder coated pedals and zinc plated rail assembly for long lasting, new appearance. Pedal adjusts by tilting and sliding along the runner. Pad color may vary.

 **1120** UPS SHIPPABLE 12 LBS. **\$99.00**

E
1117



[E] Collegiate Starting Block
Milled, solid, anodized, aluminum construction. 90mm long x 7mm thick slotted channel. Spikes in the front and back for greater stability on synthetic tracks. Pedals made with PVC pad and are adjustable at 5-angles. 7-1/2" x 5" shoes. Pad color may vary. IAAF certified.



 **1117** UPS SHIPPABLE 1 @ 9 LBS. & 1 @ 4 LBS. **\$215.00**

D
1114

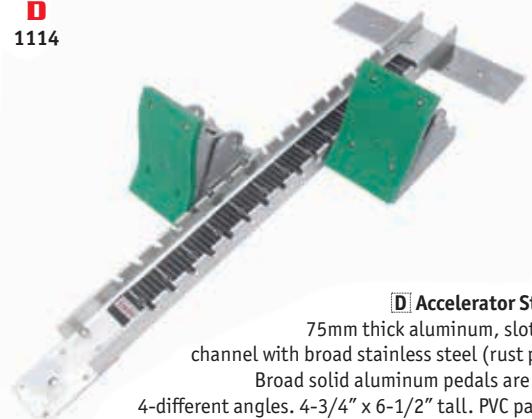

[D] Accelerator Starting Block
75mm thick aluminum, slotted anodized channel with broad stainless steel (rust proof) plates. Broad solid aluminum pedals are adjustable to 4-different angles. 4-3/4" x 6-1/2" tall. PVC pads on pedals. **Anchor pins and all-weather spikes included.**

 **1114** UPS SHIPPABLE 16 LBS. **\$159.00**

FOR ALL JUDGING NEEDS, PLEASE SEE PAGE 25



F
1118

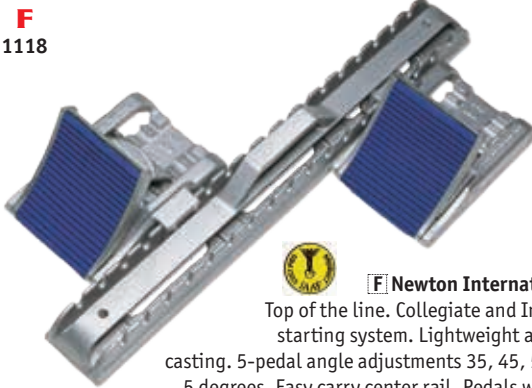

[F] Newton International Block
Top of the line. Collegiate and International starting system. Lightweight all aluminum casting. 5-pedal angle adjustments 35, 45, 55, 60 and 65 degrees. Easy carry center rail. Pedals will not come off rail during transport. Threaded spikes for synthetic surface. Two 6" spikes for dirt are included. IAAF certified.



 **1118** UPS SHIPPABLE 16 LBS. **\$489.00**

G
1122



G Indoor Starting Blocks
Brown plastic blocks. Adheres to any clean floor without glue or pins. Easily removable. (Recommended 2nd person support blocks with feet from behind).

1122 **\$48.00/pr**
UPS SHIPPABLE 7 LBS.

H
1121



[H] Starting Block Anchor Pins
For use with starting block #1120. (Not included with the purchase of the block itself).

 **1121** **\$4.50/ea**
UPS SHIPPABLE 1 LB.

I
1124



I Implement Rack

Heavy-duty tubular steel. Holds 14-assorted discus, 14-shot puts and 14-hammers. 8" fixed semi-pneumatic wheels, 5" swivel solid rubber casters on front. 36"W x 36"H X 27"D at base.

1124 UPS SHIPPABLE 82 LBS. **\$752.00**

J
1128



★ BUNGEE CORDS KEEP BLOCKS SECURE OVER ANY TERRAIN! ★

J Universal Starting Block Cart

Capable of transporting 10-starting blocks. Steel construction. Top tray to place block shoes or other smaller equipment. 4-8" cushion heavy-duty tires for easy pushing from swivel end on grass or hard surfaces.

1128 UPS SHIPPABLE 1 @ 85 LBS + AH, 1 @ 27 + AH. **\$815.00**

K
1127



K Starting Block Cart

Capable of holding 12-starting blocks. Steel construction. Large base tray to store shoes. 3" swivel rubber wheel casters.

1127 UPS SHIPPABLE 1 @ 58 LBS + AH **\$330.00**

L
1125



L Steel Equipment Wagon

Heavy-gauge, steel-mesh bed with fold-down sides. Bolts are welded to the bed for quick assembly. Towable. Pneumatic 13" Wheels. Capacity 6.0 cubic feet. Weight limit 1000 lbs. Color may vary.

1125 UPS SHIPPABLE 78 LBS + AH **\$370.00**

EVERTUFF® THE MOST ECONOMIC SOLUTION ★ TO OLD, WORN-OUT RUNWAYS. ★

M Evertuff® Roll-Out Runway

Spike resistant, all weather. Made from recycled plain black rubber with polyurethane binder. For use on concrete, asphalt, or on a level smooth surface.

| | | |
|----------------|--|-----------------|
| 1608 | Custom 8mm runway 48" width /per linear foot | \$16.00 |
| 1608-25 | 25' Precut 8mm runway 48" width /each | \$375.00 |
| 1608-50 | 50' Precut 8mm runway 48" width /each | \$750.00 |



8mm THICKNESS

M
1608
1608-25
1608-50

THE LARGEST SELECTION OF SPIKES
★ **AVAILABLE ANYWHERE!** ★

Traditional Steel Spikes
heat treated, zinc plated



---- blank 1/8" needle 1/8" pyramid 1/4" needle 1/4" pyramid 3/16" pyramid 3/16" needle 3/8" needle 3/8" pyramid 1/2" pyramid 5/8" pyramid

A 7199 **Javelin Spikes**
1" in length.
Retail Packaged
20-Spikes Per Bag
7199 \$12.50

B **Steel Track Spikes With Wrench**
A 3-way key wrench in a clamshell for attractive retail display.
Retail Packaged 12-Spikes Per Bag

| | | |
|------|---------------|---------|
| 7786 | 1/8" needle | \$10.00 |
| 7789 | 1/8" pyramid | \$10.00 |
| 7746 | 1/4" needle | \$10.00 |
| 7749 | 1/4" pyramid | \$10.00 |
| 7769 | 3/16" pyramid | \$10.00 |
| 7767 | 3/16" needle | \$10.00 |
| 7737 | 3/8" needle | \$10.00 |
| 7739 | 3/8" pyramid | \$10.00 |
| 7729 | 1/2" pyramid | \$10.00 |
| 7759 | 5/8" pyramid | \$10.00 |

C **Steel Track Spikes Without Wrench**
Packaged in poly bags properly labeled and punched for display.

C Steel Track Spikes Without Wrench
Packaged in poly bags properly labeled and punched for display.

Retail Packaged 14-Spikes Per Bag

| | | |
|------|---------------|---------|
| 7209 | ---- blanks | \$10.30 |
| 7286 | 1/8" needle | \$10.30 |
| 7289 | 1/8" pyramid | \$10.30 |
| 7246 | 1/4" needle | \$10.30 |
| 7249 | 1/4" pyramid | \$10.30 |
| 7269 | 3/16" pyramid | \$10.30 |

Retail Packaged 100-Spikes Per Bag

| | | |
|------|---------------|---------|
| 7109 | ---- blanks | \$15.25 |
| 7186 | 1/8" needle | \$15.25 |
| 7189 | 1/8" pyramid | \$15.25 |
| 7146 | 1/4" needle | \$15.25 |
| 7149 | 1/4" pyramid | \$15.25 |
| 7169 | 3/16" pyramid | \$15.25 |
| 7267 | 3/16" needle | \$10.30 |
| 7237 | 3/8" needle | \$10.30 |
| 7239 | 3/8" pyramid | \$10.30 |
| 7229 | 1/2" pyramid | \$10.30 |
| 7259 | 5/8" pyramid | \$10.30 |
| 7167 | 3/16" needle | \$15.25 |
| 7387 | 3/8" needle | \$15.25 |
| 7389 | 3/8" pyramid | \$15.25 |
| 7129 | 1/2" pyramid | \$27.00 |
| 7589 | 5/8" pyramid | \$27.00 |

D 7185 **Steel Spike Kit With Wrench**

D Steel Spike Kit With Wrench
All spikes are in a molded container, divided and appropriately marked. Allows the retail dealer to have all individual loose spikes available. One 3-way key wrench included.
Retail Packaged 1500-Spikes Per Kit

| | |
|------------|--------------|
| 200 Spikes | 1/8" pyramid |
| 400 Spikes | 1/4" needle |
| 400 Spikes | 1/4" pyramid |
| 200 Spikes | 3/16" needle |
| 100 Spikes | 1/2" pyramid |
| 100 Spikes | 3/8" needle |
| 100 Spikes | 3/8" pyramid |

7185 UPS SHIPPABLE 5 LBS. \$265.50

E **Steelex Track Spikes Without Wrench**
Hex base makes it the easiest spike ever made to install and remove. Case-hardened steel with a black zinc plated process gives it extreme durability.



Retail Packaged 20-Spikes Per Bag

| | | |
|------|---------------|---------|
| 7885 | 1/8" Steelex | \$10.60 |
| 7865 | 3/16" Steelex | \$10.60 |
| 7845 | 1/4" Steelex | \$10.60 |

Retail Packages 100-Spikes Per Bag

| | | |
|------|---------------|---------|
| 7485 | 1/8" Steelex | \$18.00 |
| 7465 | 3/16" Steelex | \$18.00 |
| 7445 | 1/4" Steelex | \$18.00 |

| | | |
|------|--------------|---------|
| 7835 | 3/8" Steelex | \$10.60 |
| 7825 | 1/2" Steelex | \$10.60 |
| 7435 | 3/8" Steelex | \$18.00 |
| 7425 | 1/2" Steelex | \$19.50 |



F 7181 **Basic Track Spike Wrench**
Great for recessed spike shoes and standard shoes. Does not work with hex-based spikes.
7181 \$5.90

G 7184 **3-Way Key Wrench**
Economical solution for easy spike removal or installation. Works with all Blazer track spikes.
7184 \$3.60

H 7180 1780T **Universal Spike Ratchet**
Interchangeable socket head for both traditional and Steelex spikes. Blue or color may vary.
7180 UPS SHIPPABLE 1 LB. \$14.30
Replacement Tip for Ratchet Wrench 7180T \$5.15

I 7183 **T-Handle Spike Wrench**
Heavy duty wrench for quick spike removal or installation. T-Handle Spike Wrench does not work with the hex-based spikes.
7183 \$13.60

| | | |
|--|--|--|
| <p>A Open Reel Fiberglass Tape</p>  <ul style="list-style-type: none"> • Double coated, 1/2" fiberglass tape blade is highly visible yellow allowing for increased tape visibility • Double sided printing reads in feet/inches and metric • Ground stake included. Universal end hook. Handle provides for easy rewinds. • More durable than steel, more functional than cloth tapes • Waterproof, dirt-resistant and washable for increased usage • Markings start at 4" <p>1765 100-Ft / 30 meters UPS SHIPPABLE 2 LBS. \$31.85 1766 200-Ft / 60 meters UPS SHIPPABLE 3 LBS. \$60.00 1767 300-Ft / 100 meters UPS SHIPPABLE 6 LBS. \$79.95</p> | <p>B Closed Case Steel Field Tape</p> <p>Designed to be impact resistant and long lasting.</p>  <ul style="list-style-type: none"> • Gripper Coated Case • Nylon coated steel blade with universal end hook, more functional than cloth tapes • Folding rewind crank on backside of tape measures • Tape is highly visible yellow allowing for increased tape visibility. • Small and easy to carry. <p>1760 UPS SHIPPABLE \$31.85 100-Ft x 3/8" Inches Only</p> | <p>C Field Tapes</p> <p>Open design provides lightweight durability. Meters on one-side, feet/inches on the other.</p>  <p>1700 UPS SHIP 2LBS. \$23.50 Fiberglass Field Tape 50'/15 meters 1710 UPS SHIP 2LBS. \$27.00 Fiberglass Field Tape 100'/30 meters 1720 UPS SHIP 3 LBS. \$49.00 Fiberglass Field Tape 165'/50 meters 1730 UPS SHIP 3 LBS. \$56.50 Fiberglass Field Tape 200'/60 meters 1740 UPS SHIP 4 LBS. \$80.00 Fiberglass Field Tape 300'/90 meters</p> |
|--|--|--|

D 1699



D **Measuring Cane**

Attach end of measuring tape to tip of cane for fast and easy measuring.

1699 **\$21.00**
 UPS SHIPPABLE 4 LBS.

E 1774



E **10" Measuring Wheel (Ft/In)**

- Telescoping handle collapses easily
- Gear driven 5-digit counter measures distances up to 10,000 feet to the nearest inch.
- Durable, 10-inch composite wheel. Counter reset button and spring-loaded kickstand. Measures in feet and inches.

1774 **\$141.00**
 UPS SHIPPABLE 3 LBS.

F 1775



F **Digital Measuring Wheel**

- Telescoping handle allows adjustable height and easier storage
- Electronic LCD 6-digit digital display shows six digits or four whole numbers and two decimals.
- Offers three different measuring modes: English, Metric or tenths
- Durable, 10-inch wheel. Adjustable twist and lock handle with folding kickstand.
- Measures up to 10,000 ft.

1775 **\$150.00**
 UPS SHIPPABLE 3 LBS.

G



G **Safety Pins**

1" nickel plated steel pins for competitor's numbers. Comes packed 144 each.

0955 UPS SHIPPABLE 1 LB. **\$7.30/ea**

H **Hip Number Dispenser**

Holds 9-rolls of numbers with EASY tear off bar.

0969 UPS SHIPPABLE 11 LBS. **\$130.00**

MAKES STORING & MOVING EASY FOR YOUR MEET!







I



I **Competitor's Numbers**

Large and easy-to-read numbers. Printed on heavy paper to ensure durability.

Sets **\$16.50/ea**
 Please specify the number needed when ordering.

| | |
|--|--------------------------------------|
|  | 0900 COMPETITOR'S • #01-#100 |
| | Size: 5-3/4" x 11-1/4" w |
|  | 0910 COMPETITOR'S • #101-#200 |
| | Size: 5-3/4" x 11-1/4" w |
|  | 0930 COMPETITOR'S • #301-#400 |
| | Size: 5-3/4" x 11-1/4" w |
|  | 0940 COMPETITOR'S • #401-#500 |
| | Size: 5-3/4" x 11-1/4" w |
|  | 0950 COMPETITOR'S • #501-#600 |
| | Size: 5-3/4" x 11-1/4" w |



















J



J **Hip Numbers**

Bulk roll of one number, 250 count each. 3-1/2" numbers on pressure sensitive paper with easy peel-off backing is flexible and sticks to all uniforms. A must for photo finish timing.

Bulk Roll **\$23.60/ea**

| | | | |
|---|---------------------|---|-----------------------|
|  | 09591 HIP #1 |  | 095910 HIP #10 |
|  | 09592 HIP #2 |  | 095911 HIP #11 |
|  | 09593 HIP #3 |  | 095912 HIP #12 |
|  | 09594 HIP #4 |  | 095913 HIP #13 |
|  | 09595 HIP #5 |  | 095914 HIP #14 |
|  | 09596 HIP #6 |  | 095915 HIP #15 |
|  | 09597 HIP #7 |  | 095916 HIP #16 |
|  | 09598 HIP #8 |  | 095917 HIP #17 |
|  | 09599 HIP #9 |  | 095918 HIP #18 |

UPS SHIPPABLE 1 LB.

K



K **Hip Numbers**

Set of 25. 3-1/2" number on pressure sensitive paper with easy peel-off backing is flexible and sticks to all uniforms. A must for photo finish timing.

0960 **\$28.50**
 HIP #1-#9 • Set of 25
 UPS SHIPPABLE 3 LBS.
0961 **\$28.50**
 HIP #10-#18 • Set of 25
 UPS SHIPPABLE 3 LBS.
0962 **\$31.00**
 HIP #19-#30 • Set of 25
 UPS SHIPPABLE 3 LBS.

L



L **Cross Country Hip Numbers**

Roll of #'s 1-200. Numbers are printed on pressure sensitive paper with easy peel-off backing. Flexible and sticks to all uniforms.

0965 **\$51.00**
 HIP #1-#200 • One Roll
 UPS SHIPPABLE 1 LB.



A Lap Counter With Stand & Bell

Keeps competitors and spectators informed. Easy-to-read numbers are mounted in an aluminum frame and can be changed with the flip of a lever. Both units contain ten number from 0-9. Sturdy, lightweight and easily moved with mounted wheels.

4980 UPS SHIPPABLE, 1 @ 3 LBS. + AH 1 @ 37 LBS. **\$560.00**

B Performance Indicators

Up to 5-digits for displaying performance. Aluminum upper construction, with swiveling top. All steel base for added stability. Mounted wheels make transporting easy.

| | |
|---|-------------------|
| 4981 3-Digit UPS SHIPPABLE 1 @ 16 LBS. 1 @ 26 LBS. 1 @ 5 LBS. + AH | \$572.00 |
| 4990 4-Digit UPS SHIPPABLE 1 @ 21 LBS. 1 @ 26 LBS. 1 @ 5 LBS. + AH | \$715.00 |
| 4991 5-Digit UPS SHIPPABLE 1 @ 24 LBS. 1 @ 26 LBS. 1 @ 5 LBS. + AH | \$771.00 |
| 4979 Performance Indicator Pkg | \$4,080.00 |

INCLUDES: 1-4981, 4-4990 & 1-4991 FREIGHT



G Track Judges Stand

Seats 10-people or 20-people can stand. Five rows of 48" long steps. Handrail for top three levels. Rail support along the back for safety. Red enamel finish, with galvanized seats, footrests, & backrest. Easy mobility provided by wheels 8" diameter on back.

2600 239 LBS./PR. 2-BOXES - FREIGHT ONLY **\$1,397.00**



C Portable Score Unit

8" w x 13" h digital unit. Practical, portable, and simple to use.

4950B Black **\$102.00**

UPS SHIPPABLE 2 LBS.

4950S Scarlet **\$102.00**

UPS SHIPPABLE 2 LBS.

D
4106
4112



**D Heavy-Duty Cone
Flourescent Orange**

extra durable open top cones. Weighted rubber bottoms, yet cones remain soft & crushable.

4106 6" Cone **\$8.60/ea**

UPS SHIPPABLE 1 LB.

4112 12" Cone **\$13.25/ea**

UPS SHIPPABLE 2 LBS.



E
4919

Colors may vary

E Poly-Dot Marker

9" Diameter. Spot marker for track-runway or relays. Works great for gym activities-basketball, volleyball and for PE throw down bases.

4919 **\$6.00/ea**

UPS SHIPPABLE 1 LB.



F
1300

F Field Markers

4" diameter steel, chalkboard-green disc. Names and numbers are easy to remove and write again. Speed up meets by marking every throw.

1300 Individual **\$4.50/ea**

UPS SHIPPABLE 1 LBS.

1300S Set of 12 **\$52.45/set**

UPS SHIPPABLE 4 LBS.



★ 5-BRIGHT COLORS! ★

H Runway Marker Set

For synthetic surface disc. Made of solid steel construction.

1303 UPS SHIPPABLE 6 LBS **\$26.95/set**

I Plastic Baton Great for practice.

1000 Yellow Only \$4.10

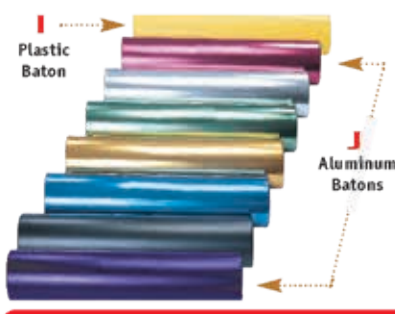

★ 7-COLORS TO CHOOSE FROM! ★

| | |
|--------------------|---------------|
| 1002 Blue | \$5.90 |
| 1003 Green | \$5.90 |
| 1004 Red | \$5.90 |
| 1005 Gold | \$5.90 |
| 1006 Silver | \$5.90 |
| 1007 Black | \$5.90 |
| 1008 Purple | \$5.90 |

⚠ WARNING: Cancer and Reproductive Harm - www.P65Warnings.ca.gov

**CALL FOR CURRENT SHIPPING REGULATIONS
* ON STARTING PISTOLS & BLANKS. ***

K
2433



2434

[K] SP-70 Yellow Electronic Starters Pistol

- Shaped like a wand, removing gun shapes out of school
- Brighter strobe light
- 3 starting tones: gun fire, beep and whistle
- Can simultaneously start Ultrak L10 Multi-Lane Timer
- Compatible with FinishLynx with additional starting cable (sold separately)
- Electronic gun is powered by 3 AA batteries (not included)
- Portable amp can be used as a microphone or loud speaker
- Amp produces 90dB to 15/feet includes rechargeable 8 hour lithium battery
- One-year warranty

2433 SP-70 Electronic Starter Set **\$315.00**

UPS SHIP 4 LBS.

2434 SP-AMP (Amp only) **\$112.00**

UPS SHIP 3 LBS.

L
2450



[L] Deluxe Import Starters Pistol with Case

Built for frequent use. Larger size for better feel. Blocked barrel and transfer bar provide tremendous safety. Swing out cylinder hold 5-209 primers. Includes foam-lined hard-shell case.

2450-209 • Primer **\$180.00**

UPS SHIP 3 LBS.

M

2460
2470

LIMITED LIFETIME GUARANTEE!



[M] ALFA Blank Pistols

The Alfa 32/.22 revolvers are rugged and reliable with bright orange grips made of high impact polymer and the orange cap on the barrel is a reminder that the revolver is not a firearm. The six shot swing out cylinder allows easy loading and unloading. A lanyard ring is included for security. Comes complete with a carrying case and cylinder cleaning brush. Winchester .32/.22 blank ammunition is recommended.

2460 • 22-Cal. UPS SHIP 2 LBS **\$425.00**

2470 • 32-Cal. UPS SHIP 2 LBS **\$425.00**

N

2320, 2222, 2222C



CALL FOR STOCK

[N] Blank Ammo

50-cartridges per box. Ship weight 1/2 lb.

2320 • Winchester 32 Caliber Heavy smoke **POR**

2222 • Winchester 22 Caliber Medium smoke **POR**

* Prices are subject to change according to current market.

O
209P



[O] 209 Primers

For use with the #2450 Deluxe Import Starting Pistol. 100-per box. No smoke or flash. Great for practice and recall.

209P • **POR**

UPS SHIPPABLE 1 LB.

P
2585

[P] Red & White Foul Flags

Helps officials broadcast fouls in field and running events.

2585 **\$16.50**

UPS SHIPPABLE 1 LB.



Q

2451
[Q] Rugged Nylon Belt Holster

Durable, comfortable & secure. Velcro® safety strap firmly holds pistol in place, yet permits easy removal.

2451 **\$30.00**

UPS SHIPPABLE 1 LB.



R
2324



[R] 32 Cal Universal Starter Blanks

50-cartridges per bag.

2324 **POR**

Ship weight 1/2 LB.



S
2587

[S] Yellow & White Umpires Flag

Helps umpires signal infractions and irregularities during a race.

2587 **\$16.50**

UPS SHIPPABLE 1 LB.



30 YEAR WARRANTY!

T
1302

[T] Digital Implement Scale

55 LB capacity. Accurate to 0.1oz. Easy to read. Extra large "easy press" buttons. Powered by 4 "C" cell batteries (not included). Detachable faceplate.

1302 UPS SHIPPABLE 9 LBS. **\$100.95**

★ WEIGHS ALL SIZES OF IMPLEMENTS! ★



NEW AND IMPROVED ADAPTORS NOW INCLUDED

HEARING PROTECTION RECOMMENDED WHEN USING ANY STARTER PISTOL!

U
2586

[U] Starter Sleeve

Made of water resistant orange nylon. Elastic at both ends.

2586 • **\$13.10**

UPS SHIPPABLE 1 LB.



◆ **WARNING: Cancer and Reproductive Harm - www.P65Warnings.ca.gov**

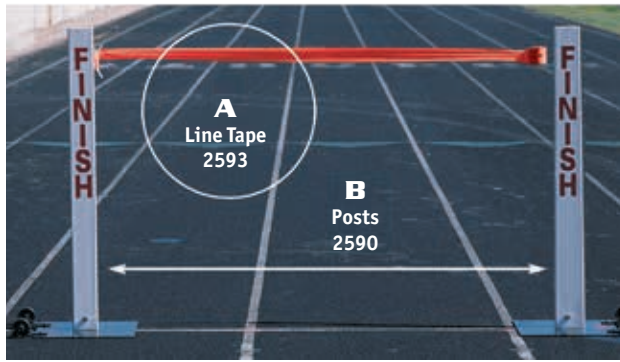

A **Line Tape**
2593

B **Posts**
2590

A **Finish Line Tape**

Bright red foam gauze tape that is light-weight and easy to break, 50-yard roll.

2593 \$5.00
UPS SHIPPABLE 1 LB.

B **Finish Line Posts**

Class up the finish line with a steel post and base. Will hold tape or yarn. Comes with a wheel kit for easy portability. Highly visible bold letters.

2590 \$454.00/pr
UPS 2 BOXES 1 @ 45 LBS., 1 @ 37 LBS.



C **Pennant Post**

Have a strong H section post molded of UV resistant polypropylene. Metal stake end of post easily inserts into hard ground. Specifications are 48" H (Includes post only.)

2902
\$16.05/ea
UPS SHIPPABLE 2 LBS.

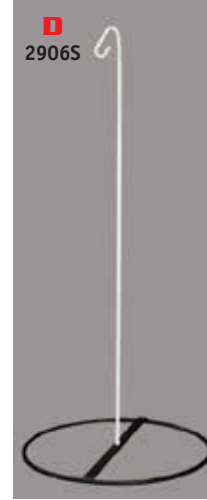

D
2906S

★ STURDY BASE ★ ALL SURFACES!

D **Steel Hard Surface Pennant Post & Stand**

Set of ten 19" round base with 4' pennant post. Designed to hold pennants on a rope over synthetic turf and hard surfaces. (Post and stand only.)

2906S
\$280.00
Set of 10 UPS SHIP 52 LBS.

★ SAVE MONEY WHEN YOU PURCHASE THE COMPLETE KIT IN 1-EASY STEP! ★



E **COMPLETE ★ CROSS COUNTRY KIT - INCLUDES:**

- #2904 1-Easy to Carry Nylon Bag
- 2902** 24-Pennant posts
- 2901** 2-120' Pennants on a rope
- 2903** 9-Directional flags w/ posts

Pennant posts are an H section, molded of UV resistant polypropylene. Directional posts are 3/4" tubular steel 80-1/2" L. Directional flags are 15" X 15" L. Poles are wedged to push into the ground easily. (Includes carrying bag.)

● 3-Red ● 3-Yellow ● 3-Blue

2900 UPS SHIPPABLE 44 LBS. + AH **\$822.25**

F

F **Chute Kit - INCLUDES:**

- 2902** • 24-Pennant Posts
 - 2901** • 2-120' Pennants on a rope
- Chute Kit pennant posts are a strong H-section molded post. Post size: 48".

2905 UPS SHIPPABLE 24 LBS. **\$444.65**



G

Directional Posts Base Features



G **Directional Flags with Posts - INCLUDES:**

- 3-Red flags w/ posts ● 3-Yellow flags w/ posts ● 3-Blue flags w/ posts
- 9 Directional posts are 3/4" tubular steel 80-1/2" L.

2903 \$315.00
(Includes flags & posts only) UPS SHIPPABLE 16LBS. + AH

★ SPECIAL COLORS ★ AVAILABLE!

H

H **Pennants On A Rope**
120', bright colored pennants. (Includes pennants only.)

2901 UPS SHIP 3 LBS. **\$36.60/ea**



I **Nylon Carrying Bag**

Durable nylon fabric carrying bag, with easy zipper closure & carrying strap. Size 20" w x 7" h. (Includes bag only.)

2904 \$86.85
UPS SHIP 6 LBS.



★ EASY TO CARRY ★ NYLON BAG W/ZIPPER!

★ NEW WALL PADDING ★

Indoor wall padding provides protection to your athletes in gymnasiums, wrestling rooms, etc. Fire resistant vinyl options - microbial and mildew resistant, too. Available in both flange and 2 channel attachment options.

14oz colors:

- Black
- Columbia Blue
- Forest
- Maroon
- Navy
- Orange
- Purple
- Red
- Royal
- Tan
- Yellow
- Kelly
- Grey White

Flange - 14oz:

| | |
|---------------|-----------------|
| 3941PF | 14oz, 65lb foam |
| 3943PF | 14oz, 95lb foam |

*PRICE ON REQUEST

Z Channel - 14oz:

| | |
|---------------|-----------------|
| 3942PZ | 14oz, 65lb foam |
| 3944PZ | 14oz, 95lb foam |

*PRICE ON REQUEST

Flange - 18oz:

| | |
|---------------|-----------------|
| 3981GF | 18oz, 65lb foam |
| 3983GF | 18oz, 95lb foam |

*PRICE ON REQUEST

Z Channel - 18oz:

| | |
|---------------|-----------------|
| 3982GZ | 18oz, 65lb foam |
| 3984GZ | 18oz, 95lb foam |

*PRICE ON REQUEST

18oz colors:

- Black
- Columbia Blue
- Forest
- Maroon
- Navy
- Orange
- Purple
- Red
- Royal
- Tan
- Yellow
- White



COMING NEXT SEASON: BACK STOP & DUGOUT TOP RAIL PADDING FOR BASEBALL





A
1808

A Pit Shovel
Head is made of 16-gauge steel with bent-forward steps for added comfort. 48" fiberglass handle. Square head is perfect for shoveling sand!

1808 \$32.00
UPS SHIPPABLE 6 LBS. + AH



B
1804
1794

B Telescopic Rake
Knocks down for easy storage in lock box. High grade aluminum alloy head. Rounded teeth are non-gouging. Double lock telescopic handle easily adjusts from 39" to 70".

1804 24' Rake \$179.60
UPS SHIPPABLE 5 LBS.
1794 36' Rake \$180.60
UPS SHIPPABLE 5 LBS.



C
1810

C Loop Hoe
Double-edged knife rock back and forth for efficient push and pull motion. 60" x 1-1/8"D. A sturdy blue powder-coated aluminum handle with 6" non-slip vinyl grip.

1810 \$66.60
UPS SHIPPABLE 6 LBS. + AH



D Field Rake
Highly recommended for professional use. Designed to specifications of professional baseball ground crews. Great for track pit maintenance. Extended strike edge engineered specifically for grading. Round teeth offer smooth non-gouging raking action. 66" powder coated handle with vinyl grip.

1802 30" UPS SHIPPABLE 5 LBS. + AH \$113.20
1795 36" UPS SHIPPABLE 5 LBS. + AH \$114.60
1803 48" UPS SHIPPABLE 6 LBS. + AH \$127.90
UPS SHIPPABLE 5 LBS. + AH



E 36" Light Lute
Light weight, heavy duty. Combines an engineered head w/strong wrap-around bracing. Solid aluminum plug-in head to handle connection. 82" powder coated aluminum handle. Great tool to have to smooth landing pit or ball diamond.

1796 UPS SHIPPABLE 6 LBS. + AH \$106.30



F 36" Roller Squeegee
Heavy duty aluminum frame construction. Stainless steel axles ensure the roller stays secure. Absorbent roller holds up to 1-gallon of water.

1798 Non-Absorbent Roller \$192.20
UPS SHIPPABLE 8 LBS. + AH
1807 PVA Absorbent Roller \$244.10
UPS SHIPPABLE 8 LBS. + AH



G
1805
1806

★ BENT OR STRAIGHT HANDLE OPTION! ★

G 24" General Purpose Broom
This 24" general purpose broom is an excellent choice for base path and infield dressing. Professional grounds keepers flip the broom over for a final dressing of the base paths. Available with either a 60" ergonomic bent powder-coated aluminum handle or a 60" straight powder coated aluminum handle.

1805 Bent Handle UPS 6 LBS. + AH \$95.20
1806 Straight Handle UPS 6 LBS. + AH \$98.40



H
1793

★ EXTRA WIDE 84" HEAVY-DUTY BROOM! ★

H Monster Broom
84" wide. Drag it on the infield or push it on the tennis court. Made with heavy duty aluminum. Two rows of bristles that are removeable for easy replacement or for adjusting broom stiffness.

1793 UPS SHIPPABLE 16 LBS. + AH \$297.00

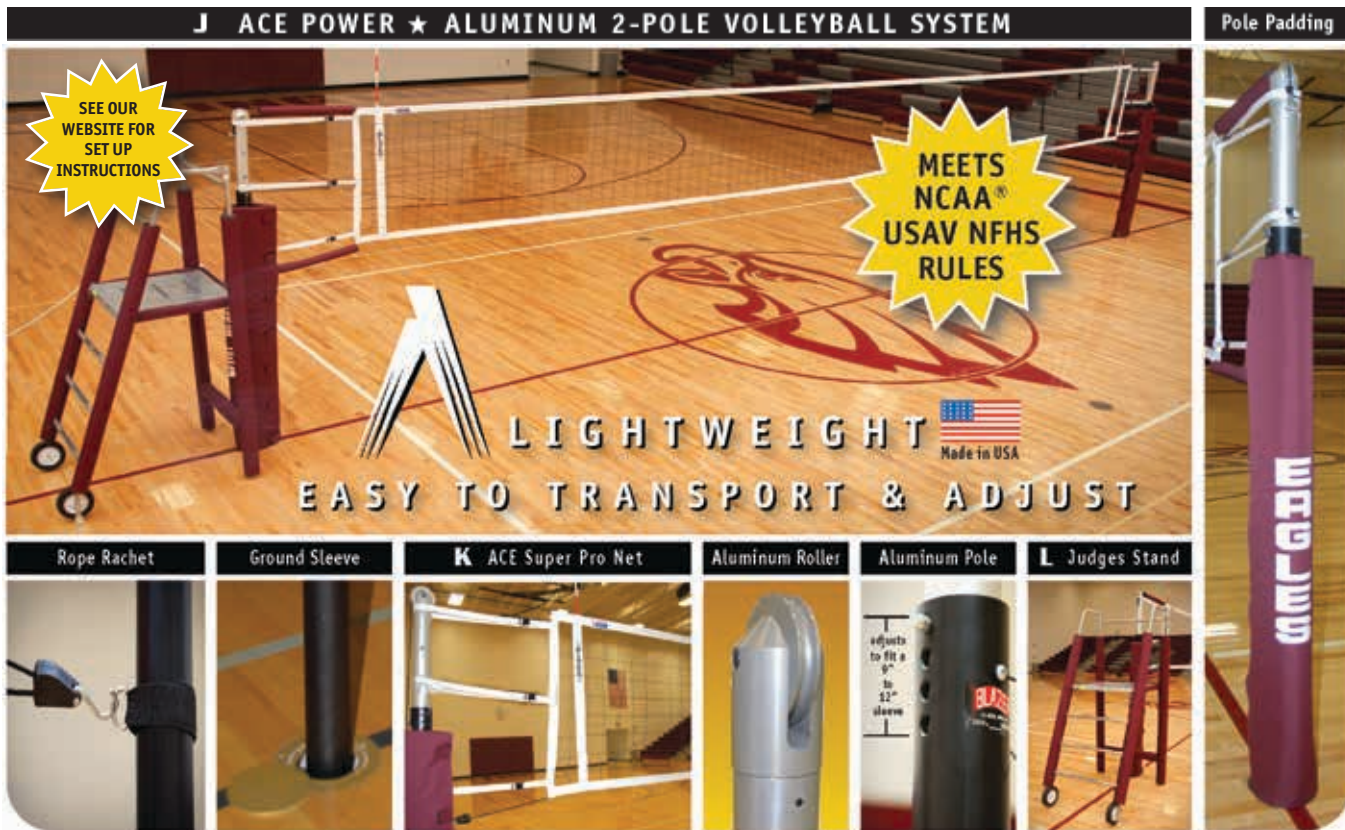

ACE POWER VOLLEYBALL POLES

These poles are UPS Shippable!

J ACE POWER ★ Aluminum 2-Pole System - With Ground Sleeves
 INCLUDES: • 2-Aluminum poles • 1-Rope ratchet • 2-Velcro® Collars w/1D Ring
 • 2-Ground Sleeves • 1-Worm gear
 Telescopic poles adjusts easily to official heights for:
MENS (7' 11-5/8") ★ WOMEN'S (7' 4-1/8") ★ JUNIORS (7') ★ YOUTH (6'6")
 Constructed of 3.5" O.D. lower powder coated aluminum tubing. Winch straps come with hooks for easy net attachment. Lower net collars are Velcro closures. Poles are constructed of high strength extruded aluminum with a combined weight of 69 lbs.

| | | |
|---------------------------------|----------------------------|-------------------|
| 6067 With Ground Sleeves | UPS SHIPPABLE 97 LBS. + AH | \$2,526.00 |
|---------------------------------|----------------------------|-------------------|

ACE POWER ★ Aluminum 2-Pole System - Without Ground Sleeves
 INCLUDES: • 2-Aluminum poles • 1-Rope ratchet • 1-Worm gear

| | | |
|--|----------------------------|-------------------|
| 6067NGS* Without Ground Sleeves | UPS SHIPPABLE 86 LBS. + AH | \$2,286.00 |
|--|----------------------------|-------------------|

*Please specify existing ground sleeve I.D., depth and center-to-center when ordering

★ SAVE MONEY WHEN YOU PURCHASE THE COMPLETE SYSTEM IN 1-EASY STEP! ★

COMPLETE ACE POWER ★ Aluminum 2-Pole System - INCLUDES:
 #6067 • 2-Aluminum poles • 1-Ground Sleeves* • 1-Worm gear
 #6054WS • 1-Super Pro net • 1-Rope ratchet • All padding for cables, poles &
 #6060 • 1-Pair Quick N' EZ antennas judges stand
 #6015 • 1-Folding judges stand with wheels

| | | |
|--|------------------|-------------------|
| 6067CP With Ground Sleeves | 205 FREIGHT ONLY | \$4,536.00 |
| 6067CPNGS* WithOUT Ground Sleeves | 195 FREIGHT ONLY | \$4,303.00 |

*Please specify existing ground sleeve I.D., depth and center-to-center when ordering



ACE POWER ★ Add a Court - INCLUDES:
 • 1-Aluminum center pole • 1-Rope ratchet • 1-Collar
 • 1-Ground Sleeve* • 1-Worm gear
 Adds 3rd pole to 2-Pole Blazer System®, to make a 3-pole side-by-side 2-court set up.

| | | |
|--|--------------|-------------------|
| 60673 With Ground Sleeve | SHIP 46 LBS. | \$1,647.00 |
| 60673NGS* Without Ground Sleeve | SHIP 40 LBS. | \$1,524.00 |

*Please specify existing ground sleeve I.D., depth and center-to-center when ordering

K Super Pro Net
 Extra strong #36 nylon flexabar treated netting. Constructed with a 41' x 1/4" top rope reinforced with KEVLAR brand fiber that will not kink like steel cable nets and 38' bottom. Net connects to the worm gear for safe and easy installation. With web strap for easy tensioning.

| | | |
|---------------|----------------------|-----------------|
| 6054WS | UPS SHIPPABLE 7 LBS. | \$405.00 |
|---------------|----------------------|-----------------|

L Volleyball Judges Stand with Wheels
 Folds together providing compact storage. Free standing sturdy 4-leg design works with any system. Made of 1-1/4" zinc plated steel tubing. Legs have protective rubber tips to prevent floor marring. Traction strips on platform & steps for safety. 80"H x 32"W x 44"D. At base, platform is 25"W x 26"D.

| | | |
|-------------|----------------------|-----------------|
| 6015 | 79 LBS. FREIGHT ONLY | \$636.00 |
|-------------|----------------------|-----------------|

A POWER ALUMINUM VOLLEYBALL POLE SYSTEMS

B UNIVERSAL ALUMINUM VOLLEYBALL POLE SYSTEMS



**MEETS
NCAA®
USAV NFHS
RULES**

Collars are equipped with spring plungers for easy and accurate lock-in to precise net heights.



Net on Universal Pole Systems easily adjusts for tennis!

★ BLAZER VOLLEYBALL SYSTEMS ARE THE ★ LONGEST LASTING ★

A POWER ★ Aluminum Volleyball Pole Systems - With Ground Sleeves

INCLUDES: ● Color-Silver
 •2-Aluminum Poles •2-Ground sleeves •1-Rope ratchet •1-Worm gear

**Adjusts easily to official heights for:
 MEN'S (7' 11-5/8") ★ WOMEN'S (7' 4-1/8") ★ JUNIORS (7')**

Constructed of 3.5" O.D. aluminum tubing with a 1/4" wall thickness. Net cable connects to the worm gear for safe and easy tightening and loosening. Winch straps come with hooks for easy net attachment. Powder coated. All collars are equipped with spring plungers for positive collar height placement.

| | |
|---|-------------------|
| 6070 ALUMINUM 2-Pole System - With Ground Sleeves | \$2,008.00 |
| <i>Requires 1-pair of pole pads for a single court set-up. 98 LBS. FREIGHT ONLY</i> | |

B UNIVERSAL ★ Aluminum Volleyball Pole Systems - With Ground Sleeves

INCLUDES: ○ Color-Powder Coated White
 •2-Poles •2-Ground sleeves •1-Rope ratchet •1-Worm gear

**Adjusts easily to official heights for:
 BADMINTON (5') ★ MEN'S (7' 11-5/8") ★ WOMEN'S (7' 4-1/8")
 JUNIORS (7') ★ YOUTH (6'6") ★ TENNIS (3') ★ PICKLEBALL (3').**

All collars are equipped with spring plungers for positive collar placement. Constructed of 1/4" wall thickness aluminum tubing. Net cable connects to worm gear for safe and easy tightening and loosening. Winch strap comes with hooks for easy net attachment. Poles are predrilled.

| | |
|--|-------------------|
| 6077 ALUMINUM 2-Pole System - With Ground Sleeves | \$2,008.00 |
| <i>103 LBS. FREIGHT ONLY</i> | |
| <i>Requires 1-pair of pole pads for a single court set-up.</i> | |
| 6077NGS* ALUMINUM 2-Pole ONLY - Without Ground Sleeves | \$1,767.00 |
| <i>94 LBS. FREIGHT ONLY</i> | |

*Please specify existing ground sleeve I.D., depth and center-to-center when ordering.

POWER ★ Aluminum Pole - Without Ground Sleeves

● Color-Silver. For a single court set-up. Does not include ground sleeves.

| | |
|--|-------------------|
| 6070NGS* Without Ground Sleeves | \$1,767.00 |
| <small>*Please specify existing ground sleeve I.D., depth and center-to-center when ordering. 91 LBS. FREIGHT ONLY</small> | |

C Custom Volleyball Standard Adaptation

666CSTD

To adapt the Blazer standard to fit an existing ground sleeve, specify the ground sleeve I.D. and depth when ordering. Blazer ground sleeves are 3-1/2" I.D. and are 12" deep. (Measured from the bottom of the sleeve to floor level.)

| | |
|-----------------|-----------------------------|
| 666CSTD* | \$110.00/per pole*** |
|-----------------|-----------------------------|

AND ★ EASIEST TO SET-UP ON THE MARKET TODAY! ★



STORES ★ EQUIPMENT ★ EASILY!

D Volleyball Store All Equipment Cart

Sturdy all steel construction. Heavy-duty, non-marking rubber casters. Base 32" wide. Designed to support 3-sets of poles, padding and antennas. Net winder holds 2-nets.

6098 \$828.00
UPS SHIPPABLE 1 @ 81 LBS. + AH, 1 @ 12 LBS.

Net winder built right in!



E Power Pole Transport Cart

Eliminate dragging poles to and from storage. Constructed of 2" square steel tubing. Hauls up to 4-poles at once. Cushioned pole rests eliminate damage to poles finish. Bottom tray provides storage of the net and other equipment. Base is 22" x 36" and rests on four swivel casters.

6099 \$522.00
UPS SHIPPABLE 1 @ 62 LBS.

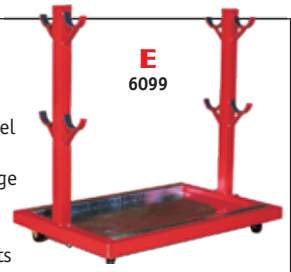

E 6099

↓ WHILE SUPPLIES LAST ↓

6651 Pole Padding in 600 Denier Cordura Finish
DISCOUNT PRICE **\$380.00**

6641 Center Pole Padding in 600 Denier Cordura Finish
DISCOUNT PRICE **\$300.00**

6611 Judges Stand Padding in 600 Denier Cordura Finish
DISCOUNT PRICE **\$445.00**

6631 Cable Padding in 600 Denier Cordura Finish
DISCOUNT PRICE **\$75.00**

F Volleyball Net Winder/Antenna Cart

Horizontally is the only good way to store a net without the cables and net being all tangled up! 2-locking casters. Steel frame construction with 4-non-marking heavy-duty casters. Capable of storing 4-nets and 2-pair of antennas. Nets and antennas purchased separately.

6111 \$447.00
UPS SHIPPABLE 1 @ 54 LBS.



F 6111

"THE CART WORKS LIKE A DREAM!"

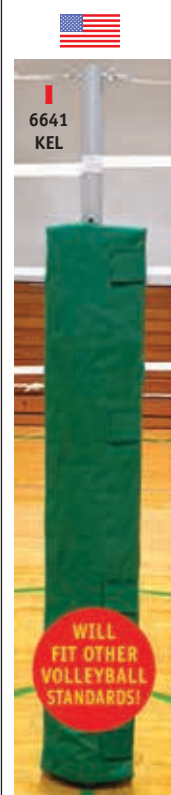

I Volleyball Center Standard Padding
Will fit other volleyball standards!

IMPROVED

2-piece set, center volleyball standard padding. For center standard padding on side-by-side and 3-court systems. 1" thick x 6' tall, covered in 14oz vinyl finish. Velcro's around the pole.

- 6641KEL-V
- 6641NAV-V
- 6641BLK-V
- 6641FOR-V
- 6641SCA-V
- 6641MAR-V
- 6641ROY-V
- 6641PUR-V

UPS SHIPPABLE 10 LBS. **\$341.00/set**

J Power Pole Pads
Will fit other volleyball standards!

IMPROVED

1-piece, wrap-around pad for power volleyball standards. 1" thick x 6' tall, covered in 600 Denier Cordura® finish. Contour fit wraps around the pole & Velcro's® into itself. Sold in pairs.

★ CUSTOMIZE ★ YOUR POWER POLE PADDING!*

- 6651KEL-V
- 6651NAV-V
- 6651BLK-V
- 6651FOR-V
- 6651SCA-V
- 6651MAR-V
- 6651ROY-V
- 6651PUR-V

UPS SHIPPABLE 12 LBS. **\$424.00/pr**
**There is a screen charge for printing on volleyball padding. Contact your dealer for screen print pricing.*



J 6651 BLK

★ DISCONTINUED ★ ORIGINAL PADDING

Call for availability

NEW DELUXE SCREENINGS



★ SAVE MONEY WHEN YOU PURCHASE THE COMPLETE SYSTEM IN 1-EASY STEP! ★

COMPLETE SYSTEMS include padding for cables, poles & folding judges stand. *See page 32 & 33 for color choices

[Link on Facebook/YouTube for setup](#)

A COMPLETE ACE POWER Aluminum 2-Pole System

- INCLUDES: #6067 • 2-Aluminum poles
 #6054WS • 2-Ground sleeves*
 #6060 • 1-Super Pro net
 #6015 • 1-Rope ratchet
 • 1-Pair Quick N' EZ antennas
 • 1-Worm gear
 • 1-Folding judges stand with wheels
 • All padding for cables, poles and judges stand

| | | |
|---|-----------------------|-------------------|
| 6067CP With Ground Sleeves | 205 LBS. FREIGHT ONLY | \$4,536.00 |
| 6067CPNGS Without Ground Sleeves | 195 LBS. FREIGHT ONLY | \$4,303.00 |

*Please specify existing ground sleeve I.D., depth and center-to-center when ordering.

COMPLETE ALUMINUM Volleyball System

- INCLUDES: #6070 • 2-Aluminum poles
 #6061 • 2-Ground sleeves
 #6059 • 1-Competition power net
 #6015 • 1-Rope ratchet
 • 1-Pair Deluxe antennas
 • 1-Worm gear
 • 1-Folding judges stand with wheels
 • All padding for cables, poles and judges stand

| | | |
|---|-----------------------|-------------------|
| 6075 With Ground Sleeves | 218 LBS. FREIGHT ONLY | \$4,036.50 |
| 6075NGS* Without Ground Sleeves | 208 LBS. FREIGHT ONLY | \$3,803.20 |
| 6073 With Ground Sleeves | 218 LBS. FREIGHT ONLY | \$4,036.50 |
| Same as above, except with #6077 UNIVERSAL Aluminum | | |
| 6073NGS* Without Ground Sleeves | 208 LBS. FREIGHT ONLY | \$3,803.20 |
| Same as above, except with #6077 UNIVERSAL Aluminum | | |

*Please specify existing ground sleeve I.D., depth and center-to-center when ordering.



JUDGES STAND FOLDS UP AND WHEELS AWAY FOR EASY MOBILITY AND COMPACT STORAGE! ★

B Volleyball Judges Stand with Wheels
 Folds together providing compact storage. Free standing sturdy 4-leg design works with any system. Made of 1-1/4" zinc plated steel tubing. Legs have protective rubber tips to prevent floor marring. Traction strips on platform and steps for safety. 80"H x 44"D. At base, platform is 25"W x 26"D.

6015 79 LBS FREIGHT ONLY **\$636.00**

B Volleyball Judges Stand Padding
 Wrap-around padding installs in minutes. Constructed of 14oz vinyl finish with 1" foam lining. Velcro® to tubing and platform.
 (Fits Blazer's 6015 only.)

IMPROVED **\$495.00**
 UPS SHIPS OVERSIZED 12 LBS. + AH



- 6611SCA-V
- 6611KEL-V
- 6611FORV
- 6611ROY-V
- 6611NAV-V
- 6611MAR-V
- 6611PUR-V
- 6611BLK-V



H POWER & UNIVERSAL Add -A-Court

- INCLUDES: • 1-Center Pole
 • 1-Ground sleeve
 • 1-Rope ratchet
 • 1-Worm gear
 • 3-Collars

Adds 3rd pole to 2-Pole Blazer System®, to make a 3-pole side-by-side 2-court set up.
6048 ALUMINUM - With Ground Sleeve
 61 LBS. FREIGHT ONLY
\$1,385.00

6048NGS* ALUMINUM - Without Ground Sleeve
 56 LBS. FREIGHT ONLY
\$1,202.00

*Please specify existing ground sleeve I.D., depth and center-to-center when ordering.

★ EASY INSTALLATION! ALL BLAZER VOLLEYBALL NETS ARE WEATHER TREATED! ★

D 6054WS Super Pro Net



FOR ACE #6067 SYSTEM

Extra strong #36 nylon flexabar treated netting. Constructed with 41' x 1/4" top rope reinforced with KEVLAR® brand fiber that won't kink like steel cabled nets and 38' bottom. Net connects to worm gear for safe and easy installation. Web straps for easy tensioning.

6054WS UPS SHIPPABLE 7 LBS **\$405.00**

E 6061 Competition Power Net

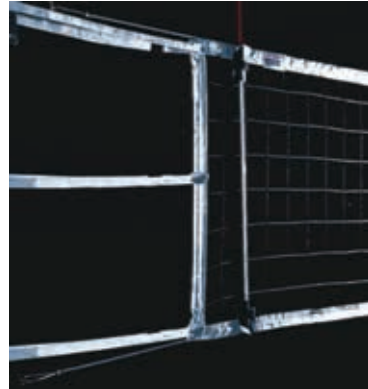

36" x 32'2" top and bottom tape. Coated steel top cable and bottom rope. Flexabar treated #24 nylon netting. All vinyl double folded and double stitched. Web straps for easy tensioning. 1/2" wood dowels. 33" long wood dowel.

6061 UPS SHIPPABLE 10 LBS **\$345.60**

F 6057 Deluxe Net

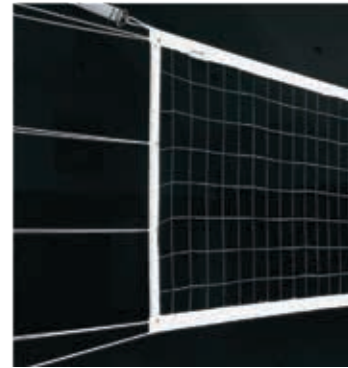

Coated steel top cable and bottom rope. Flexabar treated #24 nylon netting. Folded and stitched 2" top and bottom taped. 36" tall and 32' long. 33" long wood dowel.

6057 UPS SHIPPABLE 9 LBS **\$255.20**

Competition Collegiate Net

1m x 32'2" top with bottom tape. Coated steel top cable and bottom rope. All vinyl double folded and double stitched. Web straps are for easy tensioning. 1/2" wood dowels. 36" L wood dowels.

6064 **\$393.80**
UPS SHIPPABLE 13 LBS.

CUSTOM NETS AVAILABLE



G 6059
H 6060

G Deluxe Volleyball Antennas

Fits 36" U.S. National width net. Unique design clamps onto upper and lower cable of power net holding it firmly in place. Red & white striped.

6059 **\$166.85/pr**
UPS SHIPPABLE 13 LBS.

H Quick N' EZ Antennas

Velcro®s up and down in seconds. No more ties, clamps or hassles! Fits 36" or 39" net. Includes 2-piece antenna and Velcro® sleeve.

6060 **\$103.50/pr**
UPS SHIPPABLE 3 LBS.

R6060V **\$77.55/pr**
UPS SHIPPABLE 1 LB.

Replacement Velcro Sleeves for Quick N' EZ Antennas

FITS 36" OR 39" NET

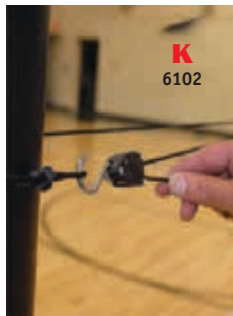

K 6102

K Net Tensioning Rope Ratchet® Set

Easy, quick, and safe. Comes in a set of 4-rope ratchets designed to function with a quick easy pull to tighten the ratchet and release with the push of a button. Works on most net systems.

6102 Set of 4
UPS SHIP 1LB. **\$47.40**

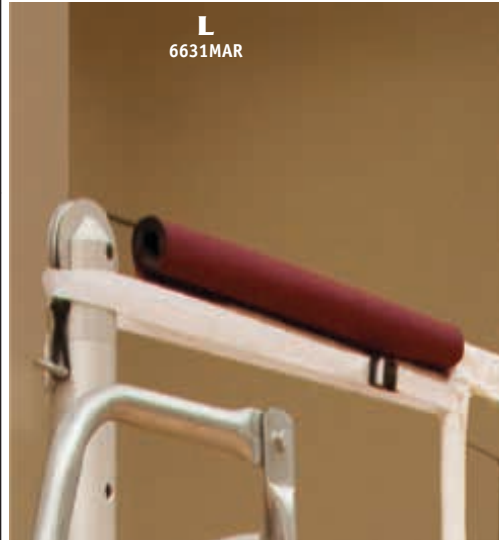

L 6631MAR

IMPROVED

M Volleyball Cable Padding

Split foam circular pad is covered by 14oz vinyl finish with Velcro® closure. Comes in a set of 4. Each is 24" L.

- 6631KEL-V
- 6631BLK-V
- 6631SCA-V
- 6631ROY-V
- 6631NAV-V
- 6631FOR-V
- 6631MAR-V
- 6631PUR-V

UPS SHIPPABLE 2LBS.
\$87.00/set

L Standard Worm Gear Winch

Easy crank worm gear winch allows precise net tension. 21:1 gear ratio. 2" net strap ensures no kinking or binding of net cable.

6063 UPS SHIPPABLE 9 LBS. **\$352.00/ea**



L 6063

K Ground Sleeve (Only)

2-piece all steel construction. 12" deep and must be cemented in. Gold anodized floor plate. Complete installation instructions included. 3-1/2" I.D., 4" O.D. Center lid swivels out of the way.

6082 UPS SHIPPABLE 13 LBS. **\$390.50/pr**



K 6082

A Volleyball 23-Matches

Rally scoring. Notation for Libero player. Scores up to 36-pts. Season summary and statistics. Scores high school or college. Follows National Federation scoring procedure. Cumulative charts, season's summary and statistics page. Scores 23 matches with spaces for 18-substitutions. Wire-bound. Line-up cards. Includes a section for comments. Updated scoring rules & substitutions. Size: 9-1/4" x 12".



5020 **\$7.90**

B Volleyball 36-Matches

Same as #5020, except with 36-matches.

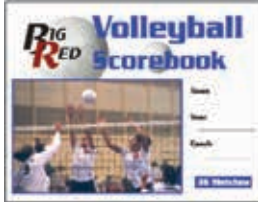

5026 **\$11.25**

C Volleyball Line-Up Cards ★ 1-Dozen

Poly bagged. Size: 6-3/4" x 4-3/8"

5222 **\$4.00**



D Volleyball Line-Up Cards ★ 144-Piece Bulk Brick

2-part NCR paper. Size: 6-3/4" x 4-3/8"

5221 **\$40.00**



E Volleyball Line-Up Card Holder ★ With 1-Dozen Cards

5292 **\$12.50**

F Net Chain Height Gauge

Easy to use for all common heights. Comes with storage bag. Measuring volleyball net height made quick and easy! Measures from the court up. No need for measuring tapes or poles. Clearly marked indicators for all common heights.



6101 **\$12.60**
UPS SHIPPABLE 1 LB.



Wall rack holds 3-Standard Uprights!

G Volleyball Standard Wall Storage Rack

Steel wall rack anchors to wall and holds 3-standard uprights with 3" industrial strength Velcro® strapping. Fits all standard makes. Hardware is not included.

6109 4 VB Pole Storage Rack UPS SHIPPABLE 12 LBS. **\$203.70**
6110 3 VB Pole Storage Rack UPS SHIPPABLE 8 LBS. **\$143.60**

H 6090



EASY PORTABILITY 30" BASE

PROTECTIVE EDGING PREVENTS FLOOR MARRING!

H Heavy-Duty Portable Base - Only

30" diameter and 250 pounds for indoor and outdoor use. Features protective edging that prevents marring of floor. Two 5" wheels for easy portability. To be used with #6092 component upright.

6090 **\$660.00/ea**
260 LBS. / EA - FREIGHT ONLY

I 6055



★ POLY WEB TRIM ★

I Recreational Net

Used with #6092 component uprights. #15 knotted black nylon with 2" poly webbing all around. Loops on corners.

6055 **\$105.00**
UPS SHIPPABLE 3 LBS.

J 6092



10' FT HIGH TO ACCOMMODATE TETHERBALL!

J Component Upright

Upright consists of 2" O.D. galvanized steel. Features 2-adjustable collars so net can be placed at appropriate height. Great for P.E., badminton, volleyball, etc., and now 10' feet high to accommodate tetherball! Use with #6090 base.

6092 **\$105.00/ea**
20 LBS. / EA - FREIGHT ONLY

K 6112



K Component Upright

Table top scorer with 7" numbers printed on one side. Period indicators. Folds flat for easy storage with a built-in handle. 24" w x 12" h. Scores 0 to 99.

6112 **\$89.90**
UPS SHIPPABLE 6 LBS.

⚠ WARNING: Cancer and Reproductive Harm - www.P65Warnings.ca.gov

★ **SAVE MONEY WHEN YOU PURCHASE THE ENTIRE SYSTEM IN 1-EASY STEP!** ★

PLAY IN THE ★ GRASS OR SAND ★ WITH THIS COMPLETE OUTDOOR SYSTEM!

SONIC OUTDOOR VOLLEYBALL SYSTEM

THESE POLES ARE UPS SHIPPABLE!

WEATHER TREATED FOR OUTDOORS!

[L] COMPLETE ★ SONIC OUTDOOR VOLLEYBALL SYSTEM - INCLUDES:

- #6040 • 2-Aluminum pole • 2-Ground sleeves • 1-Net ratchet
 - #6053 • 1-Weather treated 36" x 32' steel cable volleyball net
 - #6042 • 1-Grass & sand boundary marker set 30' x 60'
- Also includes: 4-bungees, 4-stakes, 1-cord winder
• 1-Mesh storage bag for net and accessories



Telescopic poles adjusts to 3-playing heights for: ★ MEN ★ WOMEN ★ JUNIORS

Constructed of 3.5" O.D. top section, 4" O.D. bottom section.

| | | |
|---|-----------------------|-------------------|
| 6040CP COMPLETE SYSTEM With Ground Sleeves | UPS SHIPPABLE 99 LBS. | \$1,185.40 |
| 6040CPNGS COMPLETE SYSTEM Without Ground Sleeves | UPS SHIPPABLE 89 LBS. | \$1,102.55 |
| 6040 Poles, Ratchet and Ground Sleeves Only | UPS SHIPPABLE 85 LBS. | \$825.00 |
| 6040NGS Poles Only Without Ground Sleeves | UPS SHIPPABLE 79 LBS. | \$740.00 |

[J] Boundary Marker Set ★ Orange grass and sand boundary marker set 30'x60'.

INCLUDES: 4-bungee's, 4-stakes, and 1-cord winder

| | | |
|-------------|----------------------|-----------------|
| 6042 | UPS SHIPPABLE 3 LBS. | \$117.75 |
|-------------|----------------------|-----------------|

[K] Short Court Boundary Lines

To fit court 26'3"H x 52'6"L, made of black 1-1/2"W poly tape with grommets in 4-corners and center of long side. INCLUDES: 1-mesh storage bag, 4-bungees, 4-stakes.

| | | |
|-------------|----------------------|-----------------|
| 6043 | UPS SHIPPABLE 3 LBS. | \$126.75 |
|-------------|----------------------|-----------------|

[L] Replacement ★ Outdoor Volleyball Net

Vinyl binding. Size 36"H x 32"L without dowel. 36'6" x 3/16" steel top and bottom cables. Weather treated for outdoor. Quality USA Made.

| | | |
|-------------|----------------------|-----------------|
| 6053 | UPS SHIPPABLE 7 LBS. | \$280.00 |
|-------------|----------------------|-----------------|



LIGHTWEIGHT
EASY TO TRANSPORT
& ADJUST



P
6010

Cart Holds Up to 30-Balls!

[M] Mega Volleyball Cart

This durable and lightweight ball cart holds up to 30-balls! With balls placed on top of removable cover, balls are at coach's hip level for easy access during fast-pace line drills. Swivel casters for smooth rolling. Liner constructed of 600 denier Cordura® finished vinyl, zinc plated steel legs. Quick-fold design provides simple and compact storage of your volleyballs.

Handy 24" x 12" side storage pocket. Great for clipboards, keys, crank handles and MORE! Unique design allows balls to be placed at hip level for easy access without bending over and searching for another ball. Perfect for fast-paced line drills where the coach must also watch the athlete's technique.

| | |
|-------------------|-----------------|
| 6003 Red | \$245.00 |
| 6006 Kelly | \$245.00 |
| 6007 Black | \$245.00 |
| 6010 Royal | \$245.00 |

UPS SHIPPABLE OVERSIZED 23 LBS. + AH

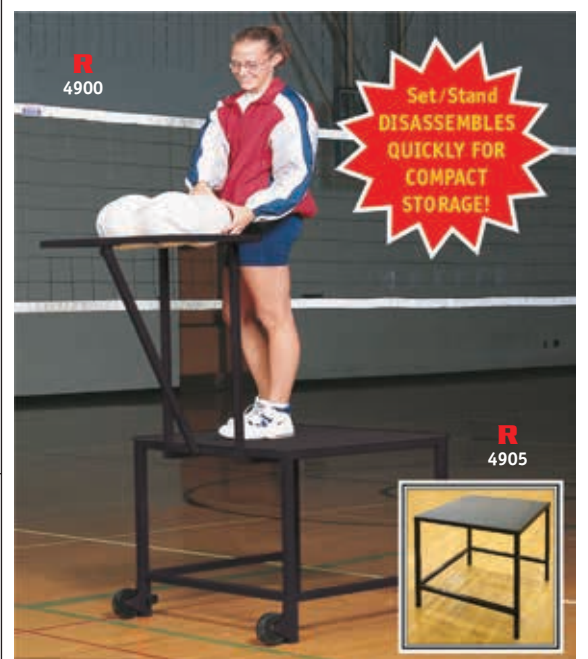

R
4900

Set/Stand
DISASSEMBLES
QUICKLY FOR
COMPACT
STORAGE!

R
4905

[N] Flag Kit - INCLUDES:

- #4912 • 4-Nylon Linesman Flags 15" x 15"
 - 1-Easy Carry Nylon Bag
 - #4913 • 2-Nylon Linesman Flags 15" x 15"
- Aluminum handle with rubber grip. Color red.

| | |
|--|----------------|
| 4912 • Set of 4 Flags & Carry Bag | \$48.25 |
| UPS SHIPPABLE 5 LBS. | |

| | |
|-------------------------------------|----------------|
| 4913 • Set of 2 Flags - Only | \$27.65 |
| UPS SHIPPABLE 2 LBS. | |



Q
4912

[R] Spike/Set Stand with Ball Rack

Super training aid for spiking & setting. Welded with 1-1/4" steel square tubing. 30"H, ball rack and wheels remove to make a plyo-box. Lightweight and easy to roll to storage. Volleyball rack top removes and folds flat for storage.

| | | |
|--|-----------------------|-----------------|
| 4900 Includes #4905 & #4034 | 168 LBS. FREIGHT ONLY | \$496.00 |
| 4905 VB Training Platform - Only | 145 LBS. FREIGHT ONLY | \$279.00 |
| 4034 Optional Wheel Kit for #4905 | (Included with #4900) | \$55.00 |

UPS SHIPPABLE 6 LBS.

WARNING: Cancer and Reproductive Harm
www.P65Warnings.ca.gov

★ CONTINUOUS FLOW ★ DRY-LINE MARKERS ★

A 50 lb. Galvanized Steel Dry-Line Marker
Internal paddle system ensures a continuous even flow!
Features a 2" or 4" line, adjustable flow from heavy to light. On/off lever on handle to eliminate bending over. Features four 8" wheels.

0817 \$280.00

UPS SHIPPABLE
1 @ 12 LBS., 1 @ 24 LBS.

B 50 lb. Dry-Line Marker
Internal paddle system ensures a continuous even flow!
Same features as the #0817 with two 8" wheels.

0821 \$225.00

UPS SHIPPABLE
1 @ 11 LBS., 1 @ 19 LBS.

C 5200

C Baseball/Softball Line-Up Card Booklet
See pg 47 for details.

5200 \$12.50

D 100 lb. Dry-Line Marker
Internal paddle system ensures a continuous even flow!
2" -OR- 4" wide line adjustment. Constructed of long lasting galvanized steel. Large capacity limits refilling. Four 8" wheels for excellent traction on all surface. Stainless steel adjustment slide for large or small powder flow. On/off rod near handle eliminates unnecessary bending over.

0819 \$345.00

UPS SHIPPABLE
1 @ 31 LBS., 1 @ 13 LBS.

E 100 lb. Complex Dry-Line Marker
Internal paddle system ensures a continuous even flow!
Designed for parks and rec and big complex facilities. 4-10" pneumatic wheels for straight line, easy tracking over rough & muddy fields. Galvanized steel hopper. 2" -OR-4" wide line adjustment. Same features of the #0819 marker.

0823 \$385.00

UPS SHIPPABLE
1 @ 13 LBS., 1 @ 38 LBS.

Internal paddle system ensures a continuous even flow!

LINE TOUCH UPS & SMALL JOBS!

F 0816

F 200 Yard Steel Dry-Line Marker
Two 6" wheels and has 2" line. 200 yard capacity. Powder coated. Every school needs this liner for line touch-ups and small jobs.

0816 \$126.50

UPS SHIPPABLE 12 LBS.

G 0842

THREE ADJUSTABLE HEIGHTS

G S.B. Hopper
Great for baseball and softball batting and pitching practice. Three height adjustments 24", 30", 36". Holds 84-baseballs or 60-softballs. Hopper is constructed of 18 oz vinyl with heavy mesh on two sides and bottom. Zinc plated steel base.

0842 UPS SHIPPABLE 26 LBS. \$127.00

★ GREAT FOR BATTING & PITCHING PRACTICE! ★

H YELLOW ★ 0856, 0858 BLACK ★ 0857, 0859

H Fence Crown™
Safe good-looking fence tops. Bright yellow or black corrugated plastic tubing. 4-1/2" diameter. Pre-slit for easy installation. 19" matching ties. Sold below.

| | | |
|-------------------------|----------------------|-----------------|
| 0856 Yellow 100' | 27 LBS. FREIGHT ONLY | \$205.00 |
| 0857 Black 100' | 27 LBS. FREIGHT ONLY | \$205.00 |
| 0858 Yellow 250' | 67 LBS. FREIGHT ONLY | \$343.00 |
| 0859 Black 250' | 67 LBS. FREIGHT ONLY | \$343.00 |

Makes installing a zip-cuts time by 75%!

I Fence Crown Tool
The installer spreads the fence crown tube and allows the tubing to close over the fence top as you pull the tool forward.

0856T \$110.00

UPS SHIPPABLE 3 LBS.

J Fence Crown Ties
19" matching ties. 100-per bag.

| | |
|-----------------------------|--------------------|
| 0860 Yellow 19" Ties | \$45.25/bag |
| 0861 Black 19" Ties | \$45.25/bag |

UPS SHIPPABLE 2 LBS.

★ **SAVE MONEY WHEN YOU PURCHASE THE COMPLETE KIT IN 1-EASY STEP!** ★

J COMPLETE ★ FIELD MAINTENANCE KIT ★



J COMPLETE ★ FIELD MAINTENANCE KIT INCLUDES:

- #1809 • 1-Sport rake
- #1810 • 1-Loop hoe
- #1797 • 1-Steel ramp
- #1793 • 1-Monster broom

1820 \$565.00

UPS SHIPPABLE 1 @ 10 LBS. + AH, 1 @ 21 LBS. + AH, 1 @ 18 LBS. + AH

ALL 4 IN ONE ★ PACKAGE! ★

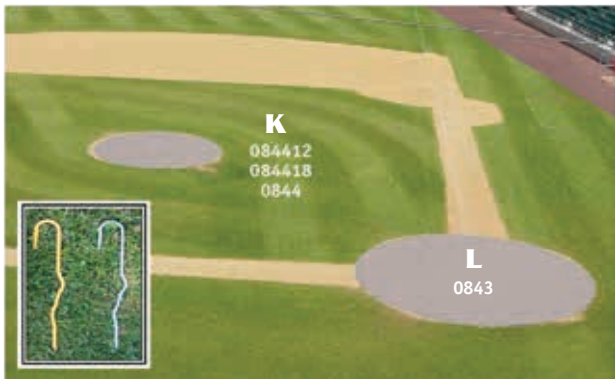

K

084412
084418
0844

L

0843

K Pitcher Mound Weather Cover

Waterproof. 6-oz. woven polyethylene.

Colors: Silver/white

084412 12' DIAMETER \$135.00

INCLUDES: 5-stakes UPS SHIP 10 LBS.

084418 18' DIAMETER \$230.00

INCLUDES: 6-stakes UPS SHIP 14 LBS.

0844 20' DIAMETER \$281.00

INCLUDES: 7-stakes UPS SHIP 19 LBS.

L Home Plate Weather Cover

Waterproof. 26' diameter.

6-oz. woven polyethylene.

Includes 9-stakes.

Colors: Silver/white

0843 \$465.00

UPS SHIPPABLE 30 LBS.



M

0866

M Base Covers

6-oz. woven polyethylene waterproof weather covers for first, second and third base.

Colors: Silver/white

0866 \$297.00/set

(3) - 10' x 10' Base Covers - INCLUDES: 15-stakes

UPS SHIPPABLE 24 LBS.

N Steel Tamp

No more broken handles. Made from a 10" square, 1/4" thick steel plate, welded to a 1-5/8" OD x 42" handle with 4-gussets. Most rugged tamp you will find on the market.

N
1797

1797 \$104.70

UPS SHIPPABLE 18 LBS. + AH

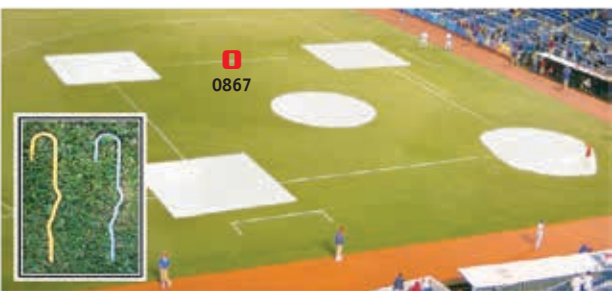
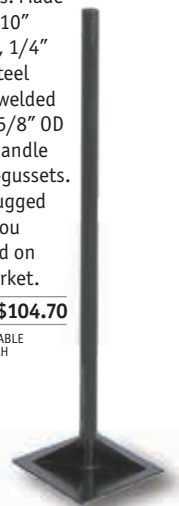

D
0867

O Complete Infield Kit

Waterproof. 6-oz. woven polyethylene. Colors: Silver/white.

0867 (3) - 10' x 10' Base Covers, (1) - 20' Pitch Mound Cover \$1,043.00/set

(1) - 26' Home Plate Covers - INCLUDES: 30-stakes, 2 storage bags UPS SHIPPABLE 78 LBS.



P
0850

P Heavy Duty Stakes

0850 \$2.50/ea

9" LONG: UPS SHIPPABLE 1 LB.

Q Loop Hoe

Double-edged knife rocks back and forth for efficient push and pull motion. 60" x 1-1/8"D. A sturdy blue powder-coated aluminum handle with 6" non-slip vinyl grip.

★ **THE PERFECT TOOL FOR GROOMING INFIELDS!** ★

Q
1810

1810 \$66.60

UPS SHIPP 6 LBS. + AH

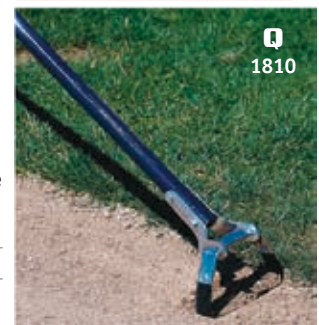

★ **CUSTOM WIDTHS & LENGTHS AVAILABLE!** ★

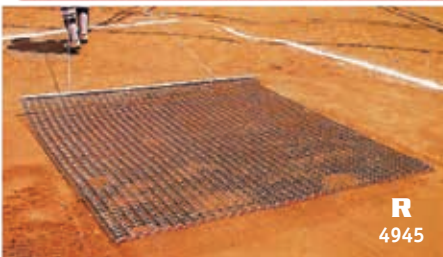

R
4945



R
4948

R Baseball/Softball Infield Drag Mat

Complete rust resistant, galvanized finish. Made of 3/8" deep 1"x1" squares. Includes 1/4" polypropylene pull rope with wooden handle. Rolls up for compact storage.

4945 6' x 6' \$632.50

UPS SHIPPABLE 63 LBS. + AH

4948 3'W x 7'L \$306.25

UPS SHIPPABLE 33 LBS. + AH

PROTECTIVE RAIN COVERS
Keep your field dry!

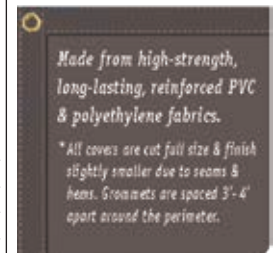



A
3415

ROPES ONLY

A Nylon Replacement Ropes ★ For Quick Adjust Trainer
Replacement ropes fit Quick Adjust Trainer that is 20' long x 5' wide. Width of squares are 24" x 30"D.

3415 Ropes only UPS SHIPPABLE 3 LBS. **\$93.20**



B
Knee High Trainers

B Knee High Trainers
Improves balance and agility. Ideal for all sports at all levels. Constructed of structural steel tubing. Completely portable and collapsible by simply pulling 3 pins. 5'w and up to 40'L. A 40' unit stores in an area 16"w, 15'L, and 9"H. Zinc plated tubing. Heavyduty shock cord stretches to prevent injury. Frame color is silver.

3160 16' FT. L \$348.70
UPS SHIPPABLE 3-BOXES, 1@4 LBS., 1@27 LBS. + AH, 1@20 LBS + AH.

3200 24' FT. L \$433.50
UPS SHIPPABLE 3-BOXES, 1@5 LBS., 1@37 LBS. + AH, 1@29 LBS + AH.

3300 32' FT. L \$636.00
UPS SHIPPABLE 3-BOXES, 1@6 LBS., 1@48 LBS. + AH, 1@39 LBS + AH.

3400 40' FT. L \$770.15
UPS SHIPPABLE 4-BOXES, 1@7 LBS., 1@49 LBS. + AH, 1@32 LBS + AH, 1@27 LBS. + AH.

Trainer ★ Replacement Ropes & Hooks

For knee high trainers.

3165 for 16' Trainer \$70.85
UPS SHIPPABLE 3 LBS.

3222 for 20' Trainer \$82.80
UPS SHIPPABLE 3 LBS.

3225 for 24' Trainer \$90.05
UPS SHIPPABLE 4 LBS.

3333 for 30' Trainer \$113.80
UPS SHIPPABLE 4 LBS.

3335 for 32' Trainer \$117.75
UPS SHIPPABLE 5 LBS.

3445 for 40' Trainer \$134.80
UPS SHIPPABLE 5 LBS.

C
5190

SEE PAGE 46 FOR DETAILS



C Football Stat Book

Scores 12-games. 78-sheets on 156-pages. 9-1/4" H x 12" W.

5190 \$17.45/ea



D 3413
EZ Kick Holder

D EZ Kick Holder

Football kicking holder constructed with heavy enameled steel base with flexible rubber tube to hold tip of football at desired position.

3413 UPS SHIPPABLE 5 LBS. **\$49.80**



E
3500

D Football Crash Pad

Ideal for football, wrestling, cheerleading, gymnastics, and more. 8" High Density foam allows for maximum shock absorption. 18 oz. vinyl that is microbial and mildew resistant. Mesh side walls allow maximum air flow to increase seam life.

3500 POR

WARNING: Cancer and Reproductive Harm - www.P65Warnings.ca.gov

J Save-A-Pad

One fits over #3020 shoulder pad rack upright to support bottom pad from getting flattened. 1-per upright needed.

3021 \$142.00/ea
UPS SHIPPABLE 6 LBS.

E
3021



NO MORE RUINED PADS!

K Should Pad Rack

Rack transports up to 100 shoulder pads. Zinc finished base. 75"H x 59"W at base. Features Four heavyduty 3" diameter swivel casters for easy mobility. Electroplated galvanized finish. Comes unassembled.

3020 \$275.00
UPS SHIPPABLE 77 LBS. + AH

F
3020



G Display Model

2-Stack Shoulder Pad Rack
54-1/2"H x 21"W x 24"L.

3022D \$178.20
UPS SHIPPABLE 35 LBS. + AH

G
3022D



H
3022

H 2-Stack Shoulder Pad Rack

Can transport up to 50 shoulder pads, 75"H. This is the answer to your small storage problems.

3022 \$183.50
UPS SHIPPABLE 41 LBS. + AH



★ FIELDSAVER: ARMORMESH TRACK PROTECTOR AND BLANKET-STYLE TRACK PROTECTOR ★

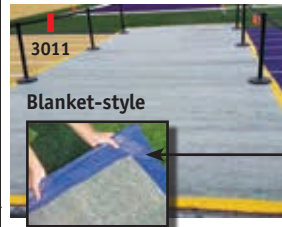

I
Blanket-style

Blanket-style

Non-woven polypropylene. Heat-tempered retains durability, even from cleats. Track Protector is available in heather gray only. Edge available in the following colors: Maple Green, Royal Blue, Red, Navy Blue, Gray, Maroon, Sky Blue, Yellow, White, Tan, Black, Kelly Green, Orange, Purple.

Overall size: 7' x 40' 15oz (Other standard sizes available)

3011 \$1,147.00

*Please note color choice when ordering.



ArmorMesh

Heavy-duty mesh retains durability, even from cleats, and allows water to drain. Available colors: Dark Green, Royal Blue, Red, Light Gray, Kelly Green, Maroon, Navy Blue, Black, Purple, Orange, Carolina Blue, Yellow, White.

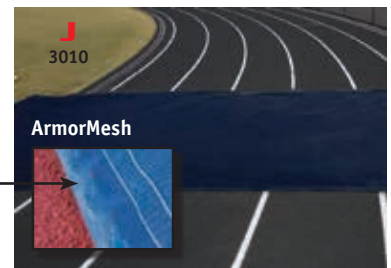

J
ArmorMesh

Overall size: 12' x 30' 14 oz (Other standard sizes available)

3010 \$1,022.00

*Please note color choice when ordering.





★ FOOTBALL GOAL POST PADDING ★



Fits up to 6" Diameter goal post. 5" thick foam wrapped in 14oz weather proof vinyl. Meets all NFHS/NCAA rules. Custom graphic printing available.

3183

3" diameter, 70" tall, 5" foam

*PRICE ON REQUEST

3186

6" diameter, 70" tall, 5" foam

*PRICE ON REQUEST

Color Options:

- Black
- Columbia Blue
- Forest
- Maroon
- Navy
- Orange
- Purple
- Red
- Royal
- Tan
- Yellow
- Kelly
- Grey White



★ TRAINING EQUIPMENT ★

K **Dual Agility Ladder with Flat Adjustable Rungs**
30' Ladder (Splits into 2-15' Ladders). (Each can be connected) Design enables the user to adjust the distance between two consecutive rungs according to their needs. D-rings on the open ends of the webbing. Carrying bag included.

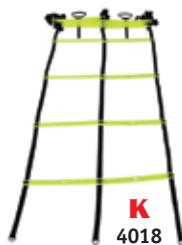

4018 • **\$66.05**

UPS SHIPPABLE 8 LBS.

L **Agility Speed Ladder "Y" Shape**
30' ladder (Splits into 3-15' Ladders). Injection Molded 21" wide adjustable rungs. Anchors and carrying bag included.



4019 • **\$53.95**

UPS SHIPPABLE 7 LBS.

M **PVC Jump Rope - 8'**
Red Flexible PVC rope with black strong molded handles. Suitable for all ages.



4208 • **\$4.60**

UPS SHIPPABLE 1 LB.

N **PVC Speed Rope - 9'**
Blue Flexible PVC rope with black strong molded handles. Suitable for all ages.



4309 • **\$5.10**

UPS SHIPPABLE 1 LB.



O
4120

O **2" Marker Cones on a Stand**
Set of 50 in 5 colors on a metal stand. Multi-purpose product with a matte finish. Great for demarcating areas on fields, zones, agility training, etc. Outer diameter = 7.5"

4120 • **\$34.15**

UPS SHIPPABLE 5 LBS.



P
4130

P **2" Marker Cones with carrying strap**
Set of 40 pieces carried with Velcro strap. Multi-purpose product with a matte finish. Great for demarcating areas on fields, zones, agility training, etc. Outer diameter = 7.5"

4130 • **\$27.85**

UPS SHIPPABLE 3 LBS.

Q **Multi Height Training Hurdles - Set of 6**
Great for all sports, improves speed in all directions. Height adjusts to both 9" and 12". Rotatable jointers allow for easy folding and unfolding of hurdles. Hurdles are bright orange to stand out against any background. Comes with storage bag. Hurdle Width=18".



4928 • **\$71.30**

UPS SHIPPABLE 10 LBS.

R **Speed Rings - Set of 12**
Set of 12 flat speed rings. Velcro Straps included, enabling the user to connect rings if needed. Carrying bag included. Inside diameter = 14"



4027 • **\$31.20**

UPS SHIPPABLE 3 LBS.

⚠ **WARNING: Cancer and Reproductive Harm - www.P65Warnings.ca.gov**



A FormFinder, Self Training Device

Training device forces the hurdler into correct body position. Keeps hurdlers arm movement in. Makes hurdler bring trail leg under armpit. Self-training allows coach to spend time with other event. Cloth cross-braces are Velcro® attached which break-away easily upon contact by hurdler. Uprights are powder coated steel.

1169 ♦ With Hurdle Base **\$195.00**
UPS SHIPPABLE 2 BOXES - 1@21 LBS., 1@12 LBS.

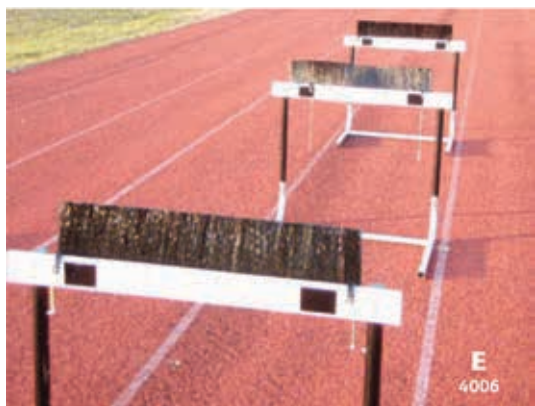

E Hurdle Sweep™ 3" + Fixture

Hurdle Sweeps™ are a soft brush edge along the top of the hurdle which provide instant technique feedback. The athlete receives tactile and audible feedback - and a coach get visual and audible information. Interchangeable brush (sweep) provides a 3" edge over the top of the actual hurdle board. The 3" sweep can be used as an actual height when the hurdle is set one notch down. *(Hurdles not included.)*

4006 ♦ **\$66.00/ea**
UPS SHIPPABLE 4 LBS.

B Mini Training Hurdles

Essential for teaching recovery mechanics and force application. Athletes learn to "snap" their legs up and down for maximum power output. Linear and lateral drills as well as plyometrics. Great for all sports, improves speed in all directions. Use 12" for linear running mechanics, 6" for lateral and change of direction speed. Hurdles are bright yellow to stand out against any background. Comes with storage bag.

4925 ♦ 12" - Set of 6 **\$71.70**
UPS SHIPPABLE 11 LBS.
4926 ♦ 6" - Set of 6 **\$70.00**
UPS SHIPPABLE 10 LBS.



C Speed Training Kit

- INCLUDES:
(9) Mini Hurdles...
(3) Each 6", 9", 12"H
(1) 20' base ladder
(1) 48" speed chute
(8) 9" high pro cones
(8) 2" high marker cones
(1) Carrying bag

4927 ♦ **\$161.70**
UPS SHIPPABLE 19 LBS.



D
1167

D X-Trainer, Collapsible

Quickly adjusts from 16" to 39" high. Great training hurdle for plyometrics, speed, and agility drills. Inexpensive for beginners or a personal hurdle for yourself. Folds flat for easy transport and storage.

1167 **\$52.00**
UPS SHIPPABLE 5 LBS.



F
4005



★ PROMOTES ★
"SQUARE AND
CENTER ATTACK!"

F Hurdle Sweep™ Target Basic Set

Target training sweeps are used for several drills. Use the Target sweeps to give the athlete a specific area to attack each hurdle with a lead leg target, trail leg target or one for each leg. Target Sweeps™ can also be used where you intend the athlete to feel feedback because they should encounter contact with the sweep - or they can be used where you want the athlete to avoid an area of the hurdle (like the inside edge on the curve to prevent hooking) in which case the athlete should not encounter and contact with the Target Sweep. Target Sweeps™ on each side of the hurdle promotes "square and center" attack. Size 2x5". 2-Fixture attachments. *(Hurdles not included.)*

4005 ♦ 8"wide, 5" tall - Set of 2 UPS SHIPPABLE 3 LBS. **\$65.00/set**

⚠ **WARNING: Cancer and Reproductive Harm**
www.P65Warnings.ca.gov



Safety Sleeve Elastics Protect your athletes, protect yourself. Limit maximum safe stretch distance. If elastic breaks, it will coil inside sleeve preventing injury. Protects elastic from wear from roads, track ... etc. Protects from overexposure to latex material. The product that uses the Safety Sleeve elastic is #4017. (Patent Pending).

**Always inspect resistance cords for wear before every workout and replace at least every 2-years. Goggles are recommended when using resistance cord devices. *NEVER stretch cord more than 3-times its length.*



G
4020

G Leap Frog

Lead runner and trailing runner take turns providing assisted acceleration. As the trailing athlete runs past the lead runner they exchange roles. The trailing athlete provides resistance to the lead runner. When the resistance cord is maxed out the trailing athlete takes advantage of the resistance to accelerate past the lead runner. 4' Safety Sleeve™ Elastic with 2-swivel belts. Continuously, alternate overspeed, passing, and resistance running. Stretches to 10'.

4020 • \$65.00
UPS SHIPPABLE 2 LBS.



H
4017

H Duo Overspeed Harness

Overspeed training is a fantastic technique to increase speed. 20' safety sleeve elastic will stretch three times its original length to 60'. At 60' with the waist belt end hooked to another runner or an anchored object, this harness will pull you faster than your top running speed, can also be used for many other drills such as leap-frog jumping. Adjustable harness fits small to XXL.

4017 • UPS SHIPPABLE 3 LBS. \$178.00



I
4014

I Dual Pull

Both athletes run together, back-runner holds back front-runner. Athletes quickly spin around & switch roles going back the other way. 10' long strap with large 3" wide loops at each end.

4014 • \$47.00
UPS SHIPPABLE 2 LBS./EA

J Base Agility Ladder

30' Ladder (Splits into 2-15' Ladders). Injection Molded 17" wide rungs. Adjustable rungs. D-rings on the open ends of the webbing. Carrying bag included.

4015 • UPS SHIPPABLE 6 LBS. \$48.95



J
4015

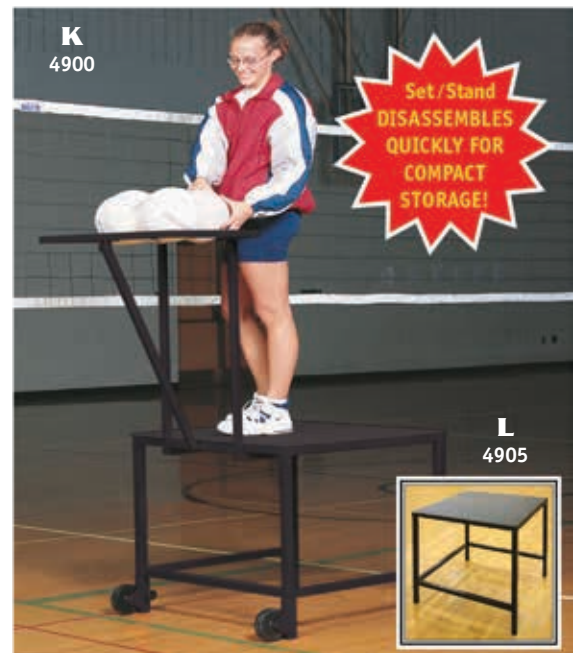

K
4900

L
4905

K Spike/Set Stand with Ball Rack

Super training aid for spiking & setting. Welded with 1-1/4" steel square tubing. 30"H, ball rack and wheels remove to make a ply-box. Lightweight and easy to roll to storage. Volleyball rack top removes and folds flat for storage.

4900 Includes #4905 & #4034 168 LBS. FREIGHT ONLY \$496.00
4905 VB Training Platform - Only 95 LBS. FREIGHT ONLY \$279.00
4034 Optional Wheel Kit for #4905 (Included with #4900) \$55.00
UPS SHIPPABLE 6 LBS.

WARNING: Cancer and Reproductive Harm - www.P65Warnings.ca.gov

**★ LESS IMPACT THAN STEEL OR WOODEN BOXES! ★
YOUR ATHLETES WILL NEVER BRUISE THEIR SHINS!**

NO ONE HAS A PLYO BOX LIKE THIS ONE! YOU CAN HAVE THE BEST OF BOTH WORLDS!



[A] Soft Plyo Box
Steel inner frame for strength and stability with a laminated, high density closed cell foam encased in 1000 denier Cordura nylon to prevent slippage. **3-SIZES IN ONE BOX! 20", 24" & 30"!**

4041 \$510.00
UPS SHIPPABLE 60 LBS.

**COLORS
MAY VARY**

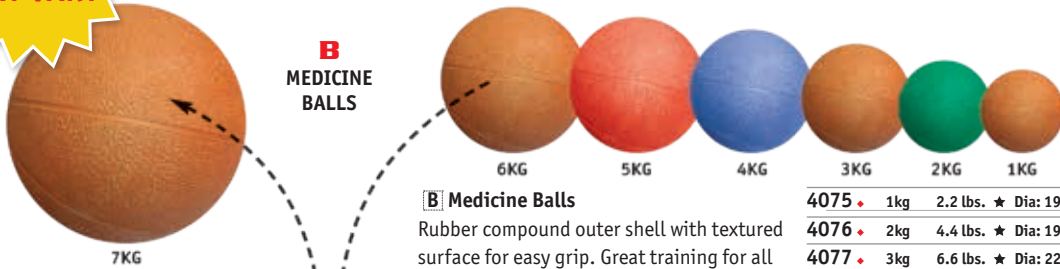

[B] MEDICINE BALLS

- **Easy grip**
- **Builds strength**
- **Balls float**
- **Great for water workouts!**

[B] Medicine Balls
Rubber compound outer shell with textured surface for easy grip. Great training for all sports and works great for an individual workout. These balls float. Great for water workouts. Balls build strength as the torso works to hold its center balance point.

| | | | | |
|------|-----|-----------|---------------------|---------|
| 4075 | 1kg | 2.2 lbs. | ★ Dia: 195mm/07.67" | \$27.50 |
| 4076 | 2kg | 4.4 lbs. | ★ Dia: 195mm/07.67" | \$32.25 |
| 4077 | 3kg | 6.6 lbs. | ★ Dia: 228mm/08.97" | \$40.00 |
| 4078 | 4kg | 8.8 lbs. | ★ Dia: 228mm/08.97" | \$53.15 |
| 4079 | 5kg | 11 lbs. | ★ Dia: 275mm/10.82" | \$63.00 |
| 4080 | 6kg | 13.2 lbs. | ★ Dia: 275mm/10.82" | \$62.35 |
| 4081 | 7kg | 15.4 lbs. | ★ Dia: 275mm/10.82" | \$83.60 |

**THESE BALLS
★ BOUNCE! ★**



**HARNESS & STRAP
★ INCLUDED! ★**

**FITS
STANDARD
-OR-
OLYMPIC
PLATES!**

[C] Quick Explode Sled with Harness
For power and explosions this is the one! Comes with 10' strap and adjustable resistance harness (fits small to XXL). Sled constructed of heavy galvanized steel. Will fit standard or olympic plates. *(Weights not included.)*

4011 • UPS SHIPPABLE 38 LBS. **\$226.00**

WARNING: Cancer and Reproductive Harm – www.P65Warnings.ca.gov

3-SIDED DESIGNED PLYOMETRIC TRAINING BOX
★ STRONG ENOUGH TO HOLD THE BIGGEST ATHLETE! ★

D Plyometric Box-30" High

Lightweight, strong, sturdy and durable box. Size dimension of 32" square x 30"H Constructed of 1-1/4" welded square steel tubing. Non-marking glides on all 4-legs. Non-slip urethane coated surface supplies cushion and protection as it wraps over the edge of the box. Strong enough to hold the BIGGEST athlete. Wheel kit assembly is available for box. Easily attaches to the legs to make moving of box FAST AND EASY! One side of box is completely open for compact storage, and easily transfers to work-out area.

4039 **\$308.00**

SHIP 61 LBS. FREIGHT ONLY

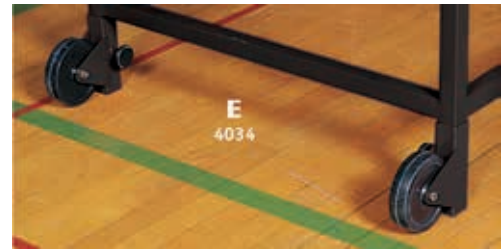

E Plyometric Training Boxes Wheel Kit

Wheel kit is easily installed and removed. Makes transporting a breeze. Wheel Kit for #4039 & #4905.

4034 **\$55.00**

UPS SHIPPABLE 6 LBS.

F
4947

BELT RELEASES CHUTE QUICK & EASILY!



★ IMPROVES STRENGTH ★
SPEED & RUNNING FORM!

F Windracer Parachute Resistance Trainer

Improves strength, speed, endurance and running form. Velcro belt releases chute quickly so athlete explodes forward and increases stride frequency. Run straight ahead, sideways and backwards. Chute includes a storage case constructed to double as a waist belt.

4947 • UPS SHIPPABLE 2 LBS. **\$51.45**

G
4024



G Bullet Belt POP + RIP Release

POP + RIP is a 48" model for starts, turns, resisted runs plus a coach controlled rip cord for smooth transition from resistance to free run when releasing athlete. Best design for developing an explosive track start. **Comes in a red carrying bag!**

4024 • UPS SHIPPABLE 3 LBS. **\$94.00**

H
4023



★ FOR TRUE EXPLOSIVE TRAINING TECHNIQUES! ★

H Bullet Belt POP Release

POP release is the 15" model for starts, turns and resisted runs. Velcro® break-away for true explosive training techniques.

4023 • UPS SHIPPABLE 3 LBS. **\$48.00**

◆ **WARNING: Cancer and Reproductive Harm - www.P65Warnings.ca.gov**

Moveable soccer goals can tip over and cause serious injury or death to children who climb on them or hang from crossbar.

3830 A
Collegiate or HS Goal



BLAZER SOCCER GOALS ARE MADE OF ROUNDED-EDGE TUBING FOR THE ULTIMATE IN SAFETY AND PERFORMANCE.

B 3820 Junior Goal

Back Bottom Brace Bar

1 Pr. Aluminum Brace Bar recommended to be used with wheel kit (#3883) and synthetic fields. For #3830 Goals.

#3884 \$630.00/pr
15 LBS./PR. FREIGHT ONLY



A ★ GOALS SOLD WITH NETS ★ B

A Collegiate or High School Goal

8'H x 24'W x 4'D x 8'B. 4" x 4" crossbar and front posts. .125 aluminum wall. 4-anchors for each goal (8-total). Portable or semi-permanent. 2.8 mm thick nets attach with permanently attached "S" hooks. Meets FIFA, NCAA® and NFHS regulations.

#3830 Nets - Included \$2,850.65/pr
480 LBS./PR. 7-BOXES - FREIGHT ONLY

B Junior Goal

6'6"H x 18'6"W x 4'D x 8'B. 4" x 4" crossbar and front posts. .125 aluminum wall. 4-anchors for each goal (8-total). Portable or semi-permanent. 2.8 mm thick nets attach with permanently attached "S" hooks. Meets FIFA regulations.

#3820 Anchors & Nets - Included \$2,589.25/pr
260 LBS./PR. GOAL - FREIGHT ONLY

★ SAVE MONEY! PURCHASE THE COMPLETE PKG IN 1-EASY STEP! ★

C ★ COMPLETE SOCCER GOAL SET PACKAGES ★ D



C COMPLETE ★ COLLEGE AND HIGH SCHOOL SOCCER GOAL SET PACKAGE - INCLUDES:

- #3830 • 1-College/HS soccer goal with net/pr
- #3883 • 1-Soccer goal wheel kit/set

#3832 \$3,061.00/set
505 LBS./PR. 8-BOXES - FREIGHT ONLY



D COMPLETE ★ JUNIOR SOCCER GOAL SET PACKAGE INCLUDES:

- #3820 • 1-Junior soccer goal with net/pr
- #3883 • 1-Soccer goal wheel kit/set

#3822 \$2,808.00/set
285 LBS./PR. 8-BOXES - FREIGHT ONLY

Youth Soccer Goal

6'6"H x 12'W x 2'D x 7'B. 4" x 4" crossbar and front posts. .125 aluminum wall. 4-anchors for each goal (8-total). Portable or semi-permanent. 2.8 mm thick nets attach with permanently attached "S" hooks. Anchors and nets included. Meets FIFA regulations.

#3825 SREIGHT ONLY 89 LBS. \$2,461.75/pr

E Polyethylene White Soccer Nets for Junior Goal

Constructed of white #21 nylon. Includes lacing cords. Sizes: 6'6"H x 18'6"W x 4'D x 8'B. Sold in pairs.

#3821 UPS SHIPPABLE 9 LBS./PR. \$473.00

F Polyethylene White Soccer Nets

Official hex woven netting soccer nets. Size: 8'H x 24'W x 4'D x 8'B. 3mm rope border.

#3831 UPS SHIPPABLE 9 LBS./PR. \$262.00

G Peewee Soccer Goal Net

Constructed of white #21 nylon. Sold in pairs. Size 4'H x 6'W 2'D at top and 4' at bottom.

#3818 UPS SHIPPABLE 5 LBS./PR. \$47.10



H 3827

H Soccer Goal Anchor Bags

Perfect for synthetic turf soccer fields. Black vinyl weight bags. 22" x 14" 18 oz. coated vinyl. Weights 40 lbs. each when filled with sand (not included). Bag attached with D-ring strap to the back corner base plates of goal.

#3827 Set of 4 for 2-Goals \$120.00
UPS SHIPPABLE 4 LBS includes 4 bags for 2 goals



I 3883

I Soccer Goal Wheel Kit

Will fit all Blazer soccer goals only! 10" Pneumatic wheel kit makes moving soccer goals a breeze. Easily detachable.

#3883 Set of 4 for 1-Field \$306.00
UPS SHIPPABLE 25 LBS.



J 3819

J Peewee/Practice Soccer Goal

4' x 6' - 1 1/2" aluminum tube powder coated goal. One piece durable construction. No assembly required. Attach nets/anchors and you're ready to play. Meets 6U, 7U and 8U recommendations.

#3819 Anchors & Nets - Included \$487.15/ea
UPS SHIPPABLE 25 LBS./EA - FREIGHT ONLY



E F G
3821 3831 3833

★ **TRANSPORT A MULTITUDE OF BALLS** ★
USES VERY LITTLE FLOOR SPACE!



K
4848
4849

[K] A-Frame Ball Cart
 Strong and durable ball cart! 1" x 16 gauge round tubing. Crosstubes are also zinc plated. 3" heavy duty swivel casters. Powder coated ends. Some assembly required.

| | | |
|--|--------------------------------------|-----------------|
| | 4848 12-Ball Rack | \$179.00 |
| | <small>UPS SHIPPABLE 30 LBS.</small> | |
| | 4849 18-Ball Rack | \$198.00 |
| | <small>UPS SHIPPABLE 38 LBS.</small> | |

★ **5-YEAR WARRANTY!** ★



L
4824

[L] 24-Ball Rack
 Great idea for P.E. storage. Stores and transports up to 24 balls at once. 3" heavy-duty swivel casters for easy mobility. Powder coated ends. 40"W x 34-1/2"H x 20-1/2"D.

| | | |
|--|--------------------------------------|-----------------|
| | 4824 | \$241.50 |
| | <small>UPS SHIPPABLE 32 LBS.</small> | |

★ **STORES UP TO 24 BALLS!** ★



M
4825

[M] Heavy Duty Ball Cage
 For extra-large capacity, 28-30 balls. Hinged top can be padlocked for security. 4 HD swivel caster wheels give easy mobility. Frame is made of 1" Powder-coated square steel tubing. 47"L x 24"W x 38"H.

| | | |
|--|--------------------------------------|-----------------|
| | 4825 | \$299.00 |
| | <small>UPS SHIPPABLE 57 LBS.</small> | |

★ **EXTRA LARGE CAPACITY!** ★



N
4826

[N] Heavy Duty 16-Ball Rack
 Welded construction for strength and durability. Steel square tubing, enamel silver paint. Heavy duty ball bearing casters. 40-3/4"H, wheel base is 18"D.

| | | |
|--|---|-----------------|
| | ● 4826 STANDARD COLOR: Silver | \$360.00 |
| | ● 4826 Special Order Color: Red | \$385.00 |
| | ● 4826 Special Order Color: Royal | \$385.00 |
| | ● 4826 Special Order Color: Black | \$385.00 |
| | ○ 4826 Special Order Color: White | \$385.00 |
| | ● 4826 Special Order Color: Forest | \$385.00 |
| | ● 4826 Special Order Color: Maroon | \$385.00 |
| | <small>UPS SHIPPABLE 53 LBS. + AH</small> | |

★ **HEAVY-DUTY!** ★



[O] Space Miser Ball Cage
 Lockable vertical steel ball cage. Store and transport a multitude of balls using very little floor space. Non-marking swivel casters provide smooth rolling. Safely stores 28-basketballs or 32-volleyballs. Can be used for all kinds of balls. Medicine, utility, etc. Standard color is red.

| | | |
|--|---|-----------------|
| | ● 4827 STANDARD COLOR: Red | \$714.00 |
| | ● 4827 Special Order Color: Royal | \$740.00 |
| | ● 4827 Special Order Color: Black | \$740.00 |
| | ○ 4827 Special Order Color: White | \$740.00 |
| | ● 4827 Special Order Color: Forest | \$740.00 |
| | ● 4827 Special Order Color: Maroon | \$740.00 |
| | ● 4827 Special Order Color: Silver | \$740.00 |

110 LBS. FREIGHT ONLY

O 4827



PLEASE ALLOW EXTRA PRODUCTION TIME FOR SPECIAL ORDER COLOR

NEW AND IMPROVED SOLID BOTTOM

PLEASE ALLOW EXTRA PRODUCTION TIME FOR SPECIAL ORDER COLOR

**★ BLAZER IS THE EXCLUSIVE DISTRIBUTOR OF ★
THE "FAMOUS" BIG RED SCOREBOOKS!**

TOTALLY PERSONALIZED FOR THE DEALER! ★ TOTALLY COMPLETE FOR THE COACH!
Blazer is the only choice for all your scorebooks!



★ BASEBALL / SOFTBALL ★

| | | | |
|---|---|--|---|
| <p>A Baseball/Softball Detailed Scorebook 12-Player Scores 24-games. Large scoring squares. 12-player, line-up cards. Season summary chart for each player. Batting average charts. <i>Size: 9-1/4" x 12"</i></p>  <p>5040 \$7.90</p> | <p>B Baseball/Softball Scorebook ★ 18-Player Scores 24-games. Large scoring squares. Same description as scorebook #5040 except space to list 18-players. Also subs with pitch count. <i>Size: 9-1/4" x 12"</i></p>  <p>5085 \$7.90</p> | <p>C Baseball/Softball Detailed Scorebook 12-Player Scores 48-games. Large scoring squares. Same as scorebook #5040 except scores 48-games. <i>Size: 9-1/4" x 12"</i></p>  <p>5090 \$12.00</p> | <p>D Baseball/Softball Side-by-Side Scorebook ★ 15-Player Scores 50-games. Score both teams on one page. Pitching count chart. Detailed format. <i>Size: 11" x 14"</i></p>  <p>5046 \$18.15</p> <p>E Baseball/Softball Enlarged Format Scorebook ★ 12-Player Scores 50-games. <i>Size: 11" x 14"</i></p>  <p>5045 \$18.15</p> |
|---|---|--|---|

★ TRACK & FIELD ★

| | |
|---|--|
| <p>F Track Meet Record Cards ★ 18-Teams Master score sheet scores 8-places for 18 teams. 20-individual event cards printed on both sides. Space for time, height, distance of all 6-place finishers. <i>Includes: 4-relay cards and 1-summary sheet. Additional cards are available upon request.</i></p>  <p>5010 \$6.25</p> | <p>G Track Scorebook 19-Meets Scores 14 individual events and 3-relays. Up to 8-places can be scored. Time, height, distance can be recorded in all places. Can be used for any size meet. <i>Size: 9-1/4" x 12"</i></p>  <p>5110 \$9.00</p> |
|---|--|



★ VOLLEYBALL ★

| | |
|---|---|
| <p>H Volleyball ★ 23-Matches Rally scoring. Notation for Libero player. Scores up to 36-pts. Season summary and statistics. Scores high school or college. Follows National Federation scoring procedure. Cumulative charts, season's summary and statistics page. Scores 23 matches with spaces for 18-substitutions. Wire-bound. Line-up cards. Includes a section for comments. Updated scoring rules & substitutions <i>Size: 9-1/4" x 12"</i>.</p>  <p>5020 \$7.90</p> | <p>I Volleyball 36-Matches Same as #5020 except with 36-matches.</p>  <p>5026 \$11.25</p> |
|---|---|

★ FOOTBALL ★

| |
|--|
| <p>J Football Stat Book ★ 12-Games 78-sheets on 156-pages. Separate pages for each team's offensive possessions. Handy play number reference column which allows coaches to look up key plays throughout the season. Separate sections for recording kicks, returns, turnovers and penalties. Detailed possession and scoring summary section. Pages for recording post-game team and individual statistics. End of season summary sheets. Additional tear-out pages for recording defensive statistics. <i>Size: 9-1/4" x 12"</i>.</p>  <p>5190 \$17.45</p> |
|--|

★ BASKETBALL ★

| | |
|--|---|
| <p>K Basketball Scorebook ★ 30-Games & Players Space to list 15-players. Running score includes space for number of individual scoring. Cumulative charts for the entire season. Season schedule and results. Wire-bound. Alternate possession chart & 3 pt. scoring. <i>Size: 9-1/4" x 12". Updated format for collegiate men and women.</i></p>  <p>5030 \$7.90</p> | <p>L Basketball Scorebook 20-Players & Games Scores 26 games. Same as the #5030 book. Season schedule results. <i>Size: 9-1/4" x 12"</i>.</p>  <p>5035 \$9.00</p> |
|--|---|

| | | | | | |
|---|---|---|--|---|---|
|  |  |  |  |  |  |
|  |  |  |  |  |  |
|  |  |  |  |  |  |

**★ CUSTOM PRINT PROGRAMS ARE AVAILABLE ★
CUSTOMIZE ALL YOUR SCOREBOOKS!**

CUSTOMIZE WITH YOUR LOGO! ★ EASY ORDERING! ★ EASY FILL-INS!
50 Qty/Style minimum to order custom scorebooks. Contact your representative for complete details.

★ SOCCER ★

[M] Soccer Scorebook
24-Matches
Charts for listing schedule and squad members. Running score, goalie save and assist sections. Space for detailed offensive & defensive record keeping. Heavy back cover provides rigid writing surface. Size: 9-1/4" x 12"



5060 \$9.00

★ LACROSSE ★

[N] Lacrosse Scorebook ★ Men's
24-Games
Roster spaces to list 33-players. Scoring space to list 26-players plus 2-goalies. Separate sections for recording penalties, face-offs, man up/man down, goalie saves and running score. Line-up cards and season summary sheets. Size: 9-1/4" x 12"



5155 \$9.00

[O] Lacrosse Scorebook ★ Women's
24-Games
Roster spaces to list 33-players. Scoring space to list 26-players plus 2-goalies. Separate sections for recording penalties, free position shot, draws, and shots on goal, goalie saves and running score. Line-up cards and season summary sheets. Size: 9-1/4" x 12"

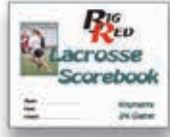

5150 \$9.00

★ TENNIS ★

[P] Tennis Scorebook
24-Matches
Both singles and doubles. Season schedule and results. Scoring record. Player analysis charts. Court diagram to show shot position, strategies, etc. Season summary for each individual. 16 and 32-tournament bracket forms, perforated. Size: 9-1/4" x 12"



5130 \$9.00

MULTI-SPORT ★ LINE-UP CARDS

[Q] Baseball/Softball Line-Up Card Booklet
35-Games
19-player line up. Substitution changes. 4-part NCR paper. Great for baseball and softball. Size: 8-1/2" x 5-1/2"

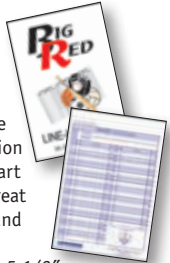

5200 \$12.50

[R] Multi-Sport Line-Up Cards ★ 1-Dozen/12-Piece



4-part NCR poly bagged. Size: 6-3/4" x 4-3/8"

5230 \$4.00

[S] Multi-Sport Line-Up Card Book ★ 12-Dozen/144-Piece
15-player line-up multi-sport cards. Sub changes. 4-part NCR paper. Great for baseball, basketball, softball, and other sports. Size: 6-3/4" x 4-3/8"



5235 \$40.00

MULTI-SPORT ★ LINE-UP CARDS

[T] Multi-Sport Line-Up Card Holder



Cards not included.

5291 \$7.75

[U] Multi-Sport Line-Up Card Holder ★ With 1-Dozen Cards



Holder with 1-dozen multi-sport line-up cards.

5290 \$12.50

VOLLEYBALL ★ LINE-UP CARDS

[V] Volleyball Line-Up Cards ★ 1-Dozen
Poly bagged. Size: 6-3/4" x 4-3/8"



5222 \$4.00

[W] Volleyball Line-Up Cards ★ 144-Piece Bulk Brick
2-part NCR paper. Size: 6-3/4" x 4-3/8"

5221 \$40.00

[X] Volleyball Line-Up Card Holder ★ With 1-Dozen Cards



5292 \$12.50



BLAZER

ATHLETIC EQUIPMENT

800 322 2731



QUALITY USA MADE

PRSRT STD
US POSTAGE
PAID
OMAHA NE
PERMIT NO 776

TECHNICAL ASSISTANCE

5109 26th Street
Columbus, NE 68601
(402) 564 2262 / Phone
(402) 564 4065 / Fax

SALES OFFICE

1720 West 23rd Street
Fremont, NE 68025
(402) 721 2525 / Phone
(402) 721 9024 / Fax
info@blazerathletic.com
**f www.facebook.com/
BlazerAthleticEquip**

ALL PRICES IN US DOLLARS ARE BASED
ON A SUGGESTED SCHOOL PRICE. FOR
FINAL PRICE, PLEASE CALL YOUR DEALER
OR
(800) 322-2731 FOR THE DEALER
NEAREST YOU.

Please route to Head Coach of your sport
if undeliverable to addressee.

**ASK US ABOUT OUR
FLIP CATALOG AND REQUEST
TO GET AN EMAILED
PRICE LIST TODAY**

CHECK OUT THESE FEATURED PRODUCTS!

NEW!

**CUSTOM PRINTING ON
PV AND HJ PITS
NOW AVAILABLE**



#1231
Varsity Flight
High Jump Pit

Olympic Double Front Pole Vault Pit
#1237DF



**BLAZER® products are distributed by and sold
through authorized sporting goods dealers. Factory
personnel are available to answer product questions and
provide information about your local dealer.**

**FIND THE DEALER NEAREST TO YOU AT
WWW.BLAZERATHLETIC.COM**

QUALITY USA MADE

