

**CARRON**

**NET**



*Quality Nets Since 1934*

# 2024 Sports Net & Recreation Equipment Catalog

BADMINTON BASEBALL BASKETBALL FOOTBALL GOLF  
LACROSSE SOCCER TENNIS VOLLEYBALL MADE-TO-ORDER NETS

# TABLE OF CONTENTS

Price list begins on Page 19

## CUSTOM NETTING SELECTOR GUIDE ..... 23

### Archery

Netting ..... 12

### Badminton

Nets ..... 5

### Baseball

Cages ..... 8, 17  
Accessories ..... 8, 9  
Cage Frames ..... 9  
Screens ("L" & Fielder) ..... 9  
Windscreens ..... 15  
Barrier (foul ball, backstop) ..... 16

### Basketball

Nets ..... 3  
Barrier & Court Divider Nets ..... 16, 18

### Cordage

Rope, Stringline, Twine ..... 13

### Football

Goal Post Nets/Practice Nets ..... 12

### Goal Nets

Soccer Nets ..... 10  
Ice Hockey Nets ..... 11  
Field Hockey Nets ..... 11  
Lacrosse Nets ..... 11  
Water Polo Nets ..... 11  
Team Handball Nets ..... 11  
Broomball Nets ..... 11  
Goal Net Accessories ..... 10

### Golf

Cages ..... 8, 14, 17  
Barrier & Practice Nets ..... 14

### Gym & Fieldhouse

Gym Dividers & Fieldhouse Nets ..... 18

### Net Bags

Ball Carrier, Equipment, Laundry ..... 13

### Pickleball

Nets ..... 4

### Pins

Laundry Pins (numbered & unnumbered) 13

### Protective Netting/Barrier Nets

Ball/Puck Barrier ..... 11  
Golf Driving Barrier Nets ..... 14  
Tennis Court Enclosures ..... 15  
Vinyl Backdrops ..... 15  
Scoreboard Protective Nets ..... 16  
Volleyball/Soccer Barrier, Area Nets.. 16

### Soccer

Nets ..... 10

### Tennis

Nets ..... 4  
Accessories ..... 4, 5, 15  
Court Dividers ..... 15  
Vinyl Backdrops ..... 15  
Windscreen ..... 15

### Volleyball

Nets ..... 6  
Accessories ..... 7  
Racquetball Court Kits & Nets ..... 7  
Barrier & Court Divider Nets ..... 16, 18



### Attention Specifiers:

With our extensive experience in the production and manufacture of new and replacement netting for fieldhouses, stadiums, athletic fields, and other custom construction applications, Carron Net can be your netting consultant. See our Architectural Resources for Specification & Design page at [www.tinyurl.com/carronnetspecs](http://www.tinyurl.com/carronnetspecs) for more details. **Items in this catalog with CSI 3-part specifications or 3D BIM objects available will feature these logos.**



### LIABILITY & WARRANTY

All Carron nets are inspected before they leave the factory and are warranted to be of good workmanship. The material is subject to deterioration from the natural aging process, improper care and damage due to vandalism. All nets should be inspected for broken meshes or any other apparent weakness before every use.

We cannot and do not guarantee freedom of injury from the use of our product. The user must assume all risk of injury due to use.

There are no warranties which extend beyond the description on the face thereof, and the merchantability of all nets is subject to deterioration.

### CLAIMS

Any claim regarding workmanship of materials must be filed within 30 days after date of shipment.

### TERMS & CONDITIONS

Prices are effective January 1, 2022, and are subject to change without notice. Terms: Net 30 days with prior approval or credit card with order. Carron Net requires no minimum order with no extra charge for drop shipments.

### RETURNED GOODS

Please contact factory for prior authorization. Ship freight prepaid to Carron Net Company, 1623 17th Street, Two Rivers, Wisconsin 54241.

**Nationwide: 800-558-7768**

**Phone: 920-793-2217**

**FAX: 920-793-2122**

**Email: [sales@carronnet.com](mailto:sales@carronnet.com)**

**Website: [www.carronnet.com](http://www.carronnet.com)**

©2022 Carron Net Company, Inc.

Reproduction without written permission is prohibited.

**Additional copies of this catalog are available  
free of charge in reasonable quantities.**



# BASKETBALL NETS

## Original Absolute Anti-Whip

Pioneered by Carron Net, the original Anti-Whip design is the very best for Professional, College and High School team use. The top half of these nets are made of durable solid fibers encased in tough 100% nylon and prevents the net from whipping up on the rim. The lower half of the net is our strongest cotton (stock #10200) or nylon (stock #10201). Use on all no-tie hoops. Available with tie cords upon request.

## 12 Top Loop Nets

"Flight Control" hourglass nets are proven stronger and longer lasting than other nets. Carron nets are available in heavy-duty braided nylon and multiple weights of cotton. For use on no-tie and ordinary hoops.

## Steel Chain Nets

A rugged, easy-to-install net for indoor and outdoor use. 12 top loops.

## 8 Top Loop "Amateur" Nets

Available in braided nylon, "Amateur" nets are made for hoops having only 8 no-tie loops. Quotes available upon request for nets for special or juvenile sets.

*standard pair packed basketball nets can be ordered single for a small upcharge.*

NUMBER	DESCRIPTION	SOLD BY
10200	Anti-Whip Net with No. 144 cotton	Pair
10201	Anti-Whip Net with braided nylon	Pair
10204	"Flight Control" Net with extra-strong No. 144 cotton	Pair
10207	"Flight Control" Net with white braided nylon	Pair
10208	No. 12 Galvanized Steel Chain Net	Single
10220	8-Loop Heavy-Duty Braided Nylon Net	Single



*Basketball nets by CARRON NET have long been the choice of teams across the nation.*

**For quality and value...choose CARRON NET!**

# TENNIS NETS

**NET CUSTOMIZATION** Custom options include net size, cable/rope length, and personalization. Custom nets are non-returnable and may require additional lead time.

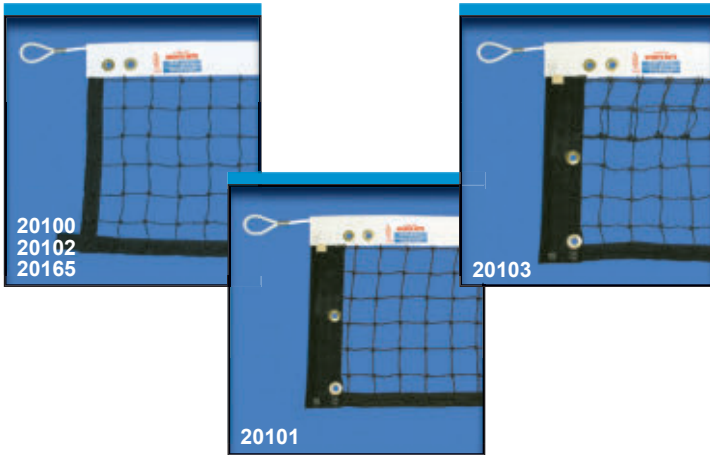

## Hercules® Tennis Nets

Our best-selling Hercules® tennis nets are constructed of #36 nylon (breaking strength of 340 lbs) which is enhanced with UV-stabilizers for maximum weather resistance. These nets feature tear resistant vinyl top binding with three rows of stitching and strong nylon webbing or vinyl side pockets (where applicable) at the sides and bottom. Top binding contains a 1/4" vinyl coated steel cable. Also available in 22' length for Platform Tennis use. For **ALL** levels of play, both indoors and outdoors. **Made in the USA.**

NUMBER	DESCRIPTION
20100	Hercules® Net – 42'x3'3", #36 Nylon, 47'x1/4" Cable
20101	Hercules® Net – like #20100 but with side pockets and dowels
20102	Hercules® Singles Net – like #20100 but 36' long with 41' Cable
20103	Hercules® Double Center Net – like #20101 but with a double layer of netting in the top 9 meshes
20165	Platform Tennis Net – 22'x2'6", #36 Nylon, 1-3/4" Mesh, 28'x3/16" Cable



## Tournament Tennis Nets

These top quality UV-stabilized nylon nets are made to last at a price you can afford. Made with heavy duty white vinyl top bindings with three rows of stitching, two large brass grommets on each end, a vinyl coated steel cable in the top binding, and tape bound sides and bottom edges. **Made in the USA.**

NUMBER	DESCRIPTION
20137	Tournament Net – 42'x3'3", #21 Nylon, 1-3/4" Mesh, 47'x1/4" Cable

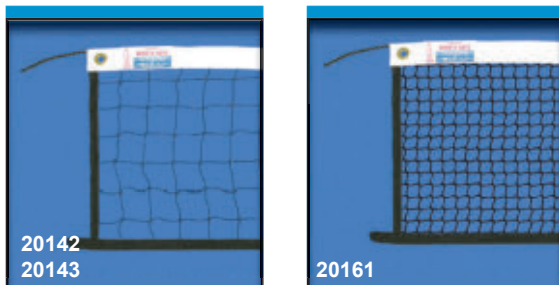

## Recreational and Paddle Tennis Nets

Recreational nets feature a lightweight yet durable nylon mesh body and a 3/16" poly rope in the white top binding for easy installation. Perfect for outdoor recreational play, indoor PE classes and anywhere nets need to be put up and taken down quickly and easily. No winch or mechanical tensioning required!

**Carron's Recreational Tennis Net (#20142)** is a regulation 42' width. The **Beach Tennis Net (#20143)** utilizes the same construction as our #20142 net but shortened to 32' to utilize beach volleyball standards. Paddle tennis and pickleball games use the **Paddle Net (#20161)** which features the same construction but with versatile 3/4" mesh netting at a length of 21'. Available in custom lengths. **Made in the USA.**

NUMBER	DESCRIPTION
20142	Recreational Net – 42'x3', #15 Nylon, 1-3/4" Mesh, Rope
20143	Beach Tennis Net – like #20142 but 2'6"Hx32'W, Rope
20161	Paddle Tennis Net – 21'x2'6", #420 Knotless Nylon, 3/4" Mesh, Rope

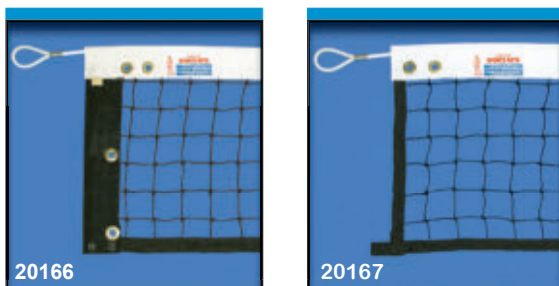

## Pickleball Nets

New official regulation sized **Hercules® Pickleball Net (#20166)** is constructed like our best-selling #20101 tennis nets with side pockets, dowels, and vinyl coated steel cable. Our **Tournament Pickleball Net (#20167)** is a cost-effective regulation sized option for winch attachment. Carron's top-quality heavy-duty **Badminton (#40600)** and **Paddle Tennis (#20161)** nets also double as popular pickleball net choices. All Carron pickleball nets can be ordered in custom lengths to fit non-standard court set-ups. **Made in the USA.**

NUMBER	DESCRIPTION
20166	Hercules® Pickleball Net – 21'9"x3', #36 Knotted Nylon, 1-3/4" Mesh, 27'x3/16" Cable
20167	Tournament Pickleball Net – 21'9"x3', #21 Knotted Nylon, 1-3/4" Mesh, 27'x3/16" Cable

# TENNIS ACCESSORIES

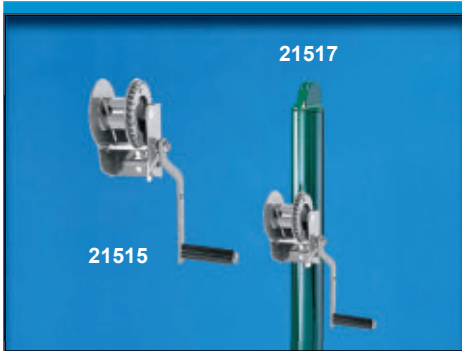

## Deluxe Tennis Post Reel

Our finest take-up tennis reel features a zinc metallic epoxy finish with automatic check latch and long detachable handle. For wood or steel tennis and volleyball posts.

## Standard Tennis Posts with Reel

These quality tennis posts are made of 2-7/8" O.D. steel pipe and are finished complete with aluminum top caps and ground sleeves for easy removal.

## Tennis Post Caps

Cast aluminum cap fits standard 2-7/8" O.D. pipe tennis posts.

NUMBER	DESCRIPTION
21515	Deluxe Tennis Post Reel
21516	Replacement Handle for Deluxe Tennis Post Reel
21517	Standard Tennis Posts with Reel, 2-7/8" O.D. and ground sleeves, green
21518	Replacement Ground Sleeves with Plastic Caps for 21517 Tennis Posts
21519	Tennis Post Caps, aluminum, fits 2-7/8" pipe



## Center Strap and Anchor

Carron center straps are made of fine quality 2-1/8" webbing. Complete with galvanized snap hook.

NUMBER	DESCRIPTION
21510	Center Strap, nylon, adjustable with snap hook
21512	Pipe Anchor for #21510, to be cemented into court, 9" long

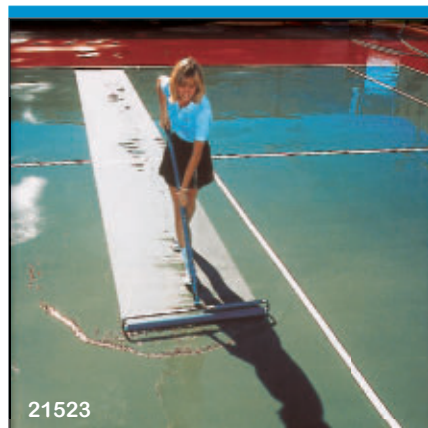

## Rol-Dri Water Remover

The Rol-Dri Water Remover is for use on any hard surface court, pool area, driveway or golf green. In a typical 1-per-court use, the easy to replace seamless roller lasts 4 months and is safe for all surfaces. For complete replacement part listing see price list stock #21550-21555 on page 20.

NUMBER	DESCRIPTION
21522	3' Seamless Replacement Roller, gray
21523	Rol-Dri Water Remover, with gray seamless roller
21525	3' Master Replacement Roller, blue

# BADMINTON

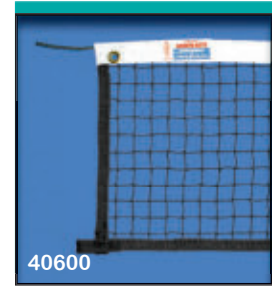

## Hercules® Badminton Net

Our finest badminton net is made of durable weather treated black #12 nylon. White vinyl top binding, taped sides and bottom. Can also be used as a regulation pickleball net. Available in custom lengths. **Made in the USA.**

NUMBER	DESCRIPTION
40600	Hercules® Super Duty Badminton Net, #12 Nylon, 21'x2'6", Rope

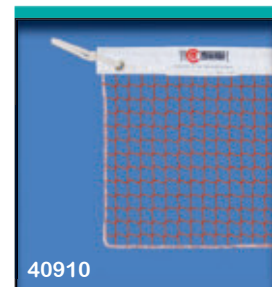

## Value Badminton Net

These economical nets feature nylon netting, double reinforced headband and top rope. Retail packed. **Imported.**

NUMBER	DESCRIPTION
40910	Value 9 ply nylon, 21'x2'6", Rope

## Replacement Items

Extend the life of tennis nets with replacement cables, ropes and bindings.

NUMBER	DESCRIPTION
21507	Vinyl Coated Steel Cable – 47'x1/4" for 42' Tennis Net
21508	Tennis Net Replacement Binding, grommated for easy attachment with lacing cord
88721	Replacement Poly Rope – 3/16" black in cut lengths

# VOLLEYBALL NETS

**NET CUSTOMIZATION** Custom options for volleyball nets include net size, cable/rope length, side straps, and personalization. Custom nets are non-returnable and may require additional lead time.

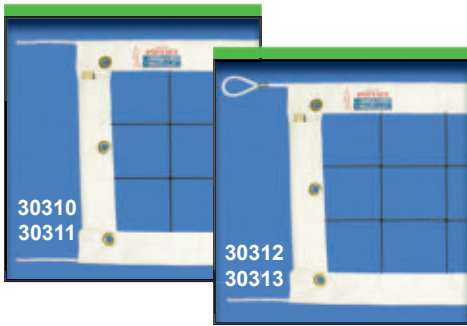

## Super Pro Volleyball Nets

Extra strong, UV stabilized weather treated #36 nylon netting with white vinyl binding on all edges, our heaviest duty net features side pockets containing wooden dowels. Choose vinyl coated steel cable or white DuPont™ Kevlar® brand fiber reinforced rope in the top binding. Standard and metric sizes available. **Made in the USA.**

NUMBER	DESCRIPTION
30310	Super Pro – 32'x3', #36 Nylon, Kevlar® Rope Top, Poly Rope Bottom
30311	Super Pro – 9.75m x 1m, #36 Nylon, Kevlar® Rope Top, Poly Rope Bottom
30312	Super Pro – 32'x3', #36 Nylon, Cable Top, Poly Rope Bottom
30313	Super Pro – 9.75m x 1m, #36 Nylon, Cable Top, Poly Rope Bottom

See Page 21 for Replacement Cables

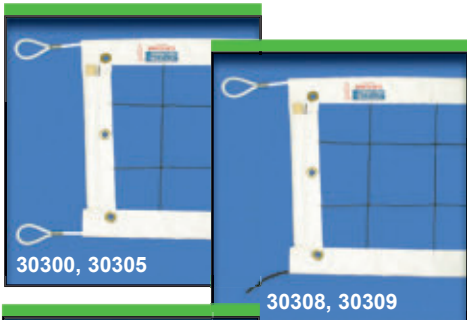

## Official Power Volleyball Nets

Our best-selling net features UV stabilized weather treated #21 nylon netting for durability, white vinyl binding on all edges, side pockets with dowels, and 8 grommets with strong nylon tie cords. Standard or metric net sizes available. **Made in the USA.**

## Hercules® Volleyball Nets

Famous Hercules® Nets are made of the same UV stabilized weather treated #21 nylon as our Official Power nets but feature tape bound bottom and ends with grommets and tie cords. The white vinyl top binding contains either a vinyl coated steel cable or poly rope. **Made in the USA.**

## Neon Volleyball Nets

Neon Volleyball Nets have the same construction featured in our Hercules® Volleyball Nets with neon orange, green or yellow headbands. **Made in the USA.**

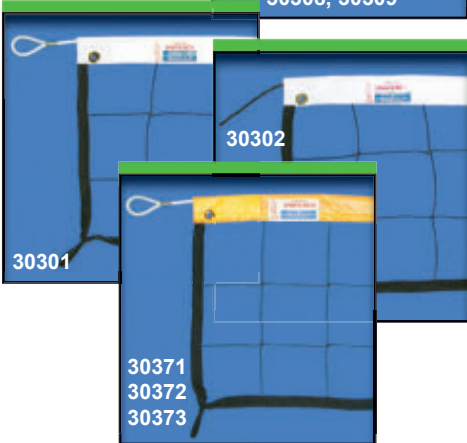

NUMBER	DESCRIPTION
30300	Official Power – 32'x3', #21 Nylon, Cable Top and Bottom
30305	Official Power – 9.75m x 1m, #21 Nylon, Cable Top and Bottom
30308	Official Power – 32'x3', #21 Nylon, Cable Top, Poly Rope Bottom
30309	Official Power – 9.75m x 1m, #21 Nylon, Cable Top, Poly Rope Bottom
30301	Hercules – 32'x3', #21 Nylon, Cable Top
30302	Hercules – 32'x3', #21 Nylon, Poly Rope Top
30371	Neon – Orange headband, 32'x3', #21 Nylon, Cable Top
30372	Neon – Green headband, 32'x3', #21 Nylon, Cable Top
30373	Neon – Yellow headband, 32'x3', #21 Nylon, Cable Top



## Reversible Volleyball Net

Popular for backyards and pool volleyball, this versatile net features white vinyl top and bottom bindings with 38" poly ropes, tape bound sides and high quality, UV stabilized and weather treated #21 nylon. **Made in the USA.**

## Recreational Volleyball Nets

Perfect for backyards and camps, these nets are made of sturdy UV stabilized weather treated #12 nylon with a poly rope in the top binding. Available in standard white and neon orange, green or yellow. Sides and bottom tape bound. Nets measure 32' x 3' with 38' x 3/16" poly rope. Retail packed. **Made in the USA.**

## Polyethylene Volleyball Nets

These nets are constructed of tough 2mm twisted polyethylene with 2" double reinforced headbands and either a vinyl coated top steel cable or poly rope. Retail packed. **Imported.** Note: these nets cannot be customized.

NUMBER	DESCRIPTION
30335	Reversible – 32'x3', #21 Nylon, Rope Top and Bottom
30381	Recreational – Neon Orange headband, 32'x3', #12 Nylon, Rope Top
30382	Recreational – Neon Green headband, 32'x3', #12 Nylon, Rope Top
30383	Recreational – Neon Yellow headband, 32'x3', #12 Nylon, Rope Top
30384	Recreational – White headband, 32'x3', #12 Nylon, Rope Top
30920	Polyethylene Volleyball Net - 32'x3', Cable Top
30921	Polyethylene Volleyball Net - 32'x3', Rope Top

## VOLLEYBALL NET UPGRADES

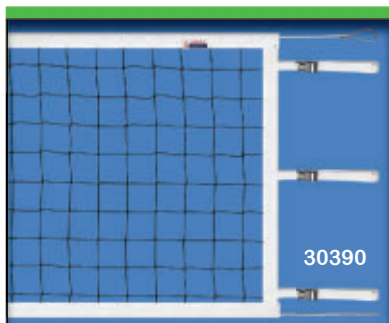

### Side Tension Straps

Upgrade any **Super Pro** or **Official Power** volleyball net with heavy duty white nylon tension straps for premium performance. Six straps (3 per side) are sewn to the net and replace grommets and tie cords. *Straps not sold separately.*

NUMBER	DESCRIPTION
30390	Side Tension Straps – Set of 6

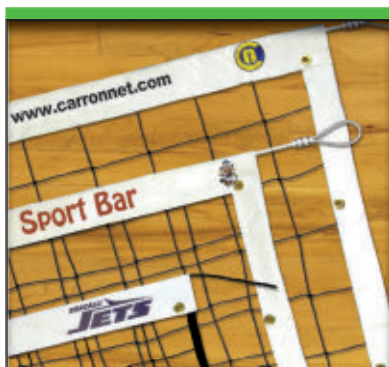

### Imprinted Headbands

Upgrade your Carron net with a 3" finished width full color, digitally printed headband. Lettering and logos can be added to any net and one charge covers printing and set-up. **Contact Factory for pricing and details.**

#### NET CUSTOMIZATION

Custom options for volleyball nets include net size, cable/rope length, side straps, and personalization. Custom nets are non-returnable and may require additional lead time.



### Replacement Volleyball Net Cables

Replacement cables are looped at both ends for easier fastening. Kevlar® rope is un-looped. See Price List for details.

NUMBER	DESCRIPTION
31432	41'x1/4" Vinyl Coated Cable
31433	38'x3/16" Vinyl Coated Cable
31434	41'x1/4" White Kevlar® Replacement Rope
88721	Replacement Poly Rope – 3/16" black in cut lengths
88723	Replacement Poly Rope – 1/4" white in cut lengths

# VOLLEYBALL ACCESSORIES



### Racquetball/Volleyball Net Kits

Here's a real profit opportunity for racquetball court operators. It's fast paced and enjoyable! Kit includes: 1 official, top quality volleyball net – 18' long to fit inside a standard racquetball court; 4 heavy-duty wall mounting plates and hardware with installation instructions; 4 heavy-duty Tensa-Net Fasteners – designed to "give" on impact; 1 Official blue Wallyball; 1 Nylon tote bag for easy storage.

NUMBER	DESCRIPTION
31420	Racquetball/Volleyball Court Kit, complete
See Page 21 for Replacement Parts (stock #31421-31426)	

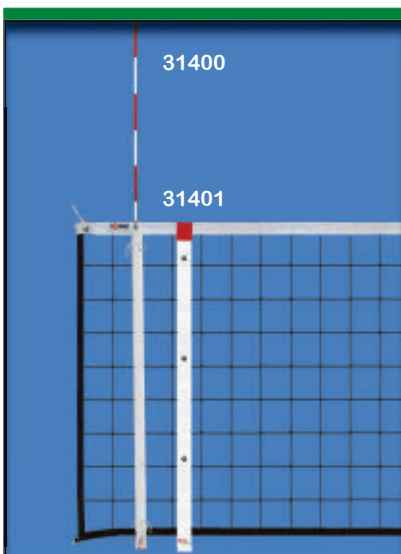

### Volleyball Antennas & Net Marker Tape

Required for official play, our antennas come apart at the center for convenience in shipping and storage. Sturdy vinyl pocket laces to net for fast, secure attachment. Net Markers attach to net with snap fasteners to define court boundaries.

NUMBER	DESCRIPTION
31400	Solid Fiberglass Antenna Rods, set of 2, 72" L x 3/8" diameter complete with pockets
31401	Net Marker Tape

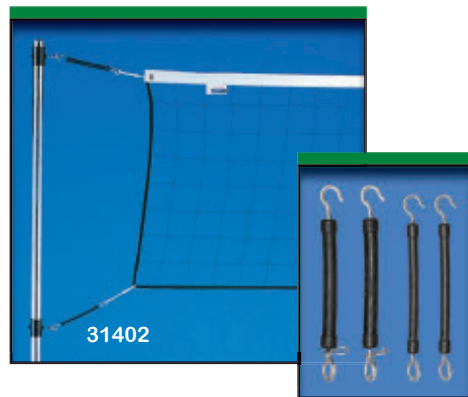

### Tensa-Net Fasteners

Keep volleyball, badminton and lightweight tennis taut with a set of four Tensa-Net Fasteners. Allows for easy set up and take down.

NUMBER	DESCRIPTION
31402	Tensa-Net Fasteners. Rubber with Steel Hooks, about 10" long – Set of 4



### Rope Tensioner

Quick-release tensioner keeps ropes taut during play and allows for easy set up and take down. For indoor or outdoor use with ropes 1/8"-1/4" diameter.

NUMBER	DESCRIPTION
31407	Rope Tensioner

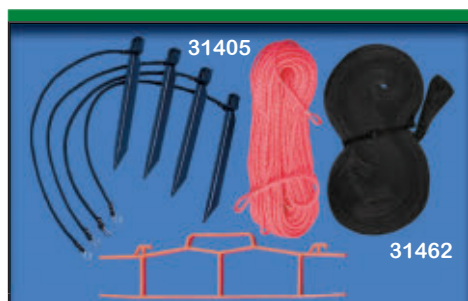

### Volleyball Court Boundary Markers

For sand or grass courts. #31405 is for 30'x60' courts; made of 1/4" braided polypropylene rope with corner loops, stakes and tension cords, durable roll up reel for storage. Short Court Markers (#31462) fit 26'3"x52'6" courts, made of 1-1/2" w poly tape with grommets in corners and center of long sides, mesh storage bag included.

NUMBER	DESCRIPTION
31405	Volleyball Court Boundary Marker
31462	Short Court Boundary Marker

# BASEBALL NETS & CAGES



75704

## Batting Cage Nets

Carron batting cages are offered in standard weight #21 nylon and heavyweight #36 nylon 1-3/4" square mesh netting for maximum abrasion resistance. All top, bottom and side edges are finished with wear-resistant 3/4" poly tape. UV-stabilized nylon netting provides outstanding durability for indoor and outdoor use.

NUMBER	DESCRIPTION
<b>Standard Duty - #21 nylon, black</b>	
60414	Batting Cage Net 12'H x 12'W x 70'L
60415	Batting Cage Net 12'H x 12'W x 75'L
60416	Batting Cage Net 12'H x 14'W x 70'L
60417	Batting Cage Net 12'H x 14'W x 75'L
<b>Heavy Duty - #36 nylon, black</b>	
60424	Batting Cage Net 12'H x 12'W x 70'L
60425	Batting Cage Net 12'H x 12'W x 75'L
60426	Batting Cage Net 12'H x 14'W x 70'L
60427	Batting Cage Net 12'H x 14'W x 75'L

## Multi-Sport Combination Cages

Baseball/golf combination cages provide great versatility and value for schools and recreation centers. Made just like our popular batting cages, these nets are constructed of 3/4" square knotless nylon golf mesh. Zippered corners are included on both sides of one long wall to allow it to be raised for multi-station golf practice. Available in white or black. A heavy duty black cage is also available in our most popular size.

NUMBER	DESCRIPTION
<b>White - #252 knotless nylon</b>	
60435	Multi-Sport Cage Net 12'H x 12'W x 75'L
60437	Multi-Sport Cage Net 12'H x 12'W x 70'L
60439	Multi-Sport Cage Net 12'H x 12'W x 55'L
<b>Black - #252 knotless nylon</b>	
60436	Multi-Sport Cage Net 12'H x 12'W x 75'L
60438	Multi-Sport Cage Net 12'H x 12'W x 70'L
60440	Multi-Sport Cage Net 12'H x 12'W x 55'L
<b>Heavy Duty - #420 knotless nylon, black</b>	
60448	Heavy Duty Multi-Sport Cage Net 12'H x 12'W x 70'L

## Baseball Backdrops

Vinyl backdrops can be used for baseball kill pads at the rear of batting cages or as barrier tarps. Constructed of 18 oz. solid vinyl with 1-1/2" finished width vinyl binding on all edges and grommets on 1' centers across the top edge. Made to order in seven available colors. See price list for details.

NUMBER	DESCRIPTION
75704	Backdrop Tarp, 18 oz. vinyl



## Custom Baseball Netting

Carron specializes in made-to-order baseball netting to fit your application. **Backstop, Foul Ball and Batting Cage** nets are available in weights appropriate for little league to college and professional play. Our expert staff can produce and manufacture ball barrier nets and baseball and combination cages to fit virtually any space or configuration requirement. See pages 16-17 for more information on custom baseball netting, or call our factory for more details.



61501

## Batting Cage/Baseball Net Repair Kit

Includes splicing needle loaded with #36 twine and a 3' x 3' piece of #36 nylon, 1-3/4" mesh to repair your batting cage or baseball net.

NUMBER	DESCRIPTION
61501	Batting Cage/Baseball Net Repair Kit



Contact CARRON NET for a quote on made-to-order batting cages. See page 17 for more information.



# BASEBALL ACCESSORIES

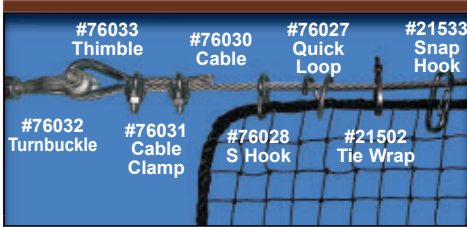

## Installation Hardware for Nets

Carron offers a complete assortment of hardware to install your nets and cages. Need help in deciding what you need? Just give our knowledgeable sales staff a call.

NUMBER	DESCRIPTION
21501	Nylon Cord, 100 yds.
21502	Tie Wrap
21533	Snap Hook, to suspend nets
76027	Quick Loop - to attach net to cable
76028	S Hook
76030	Steel Cable, 1/4" dia.
76031	Cable Clamp, to form end loops
76032	Turnbuckle, to tighten cables
76033	Thimble - to reinforce cable loops

**Due to the volatility of pricing on metal products, contact the factory for current pricing on baseball accessories.**



## Outdoor Steel Batting Cage Frames

Frames for batting cage or golf practice nets are made of 2" O.D. galvanized steel and come complete with ground sleeves for installation. The "wicket" style frame units provide support for 3 rows of 3/16" galvanized aircraft cable and accommodate 12' and 14' cage widths. Installation of the net provides approximately 12" of excess netting to contact the ground to prevent balls from rolling under.



## Fence Crown

Fence crown attaches to the top of any chain link fence and helps protect against injury while giving the playing field that finishing touch. Our 4" diameter corrugated plastic fence crown is sold in yellow or black complete with extra-long tie wraps and installation tool. Contact Carron Net for details and pricing.

62512

NUMBER	DESCRIPTION
62512	Fence Crown, Corrugated Plastic

NUMBER	DESCRIPTION
61505	Outdoor Steel Batting Cage Frame



## Steel Cable and Hardware Kit

The perfect way to suspend a cage wall-to-wall on steel cables. Carron's kit includes three 100 ft. steel cables, 12 cable clamps, 6 thimbles, 3 turnbuckles, and 75 snaps. Wall eye bolts not included.

NUMBER	DESCRIPTION
61507	Steel Cable and Hardware Kit for wall-to-wall cage suspension



## Fielder Screens

Made of heavy gauge 1-5/8" O.D. steel tubing with green powder coated finish. 7' x 7' and 10' x 10' fielder screens include 8" wheels for easy transport.

NUMBER	DESCRIPTION
62502	Small Fielder Screen - 7'x7'
62504	Replacement Slipover Net for #62502
62508	Large Fielder Screen - 10'x10'
62509	Replacement Slipover Net for #62508

## Pitcher Protector Screen

This versatile "L" shaped protector screen can be used by either left or right-hand pitchers or with pitching machines. Constructed of 1-5/8" O.D. powder coated green steel tubing, this screen features a 3'5" x 3'5" cutout and 8" wheels for easy transport.

NUMBER	DESCRIPTION
62506	Replacement Slipover Net for #62507
62507	Pitcher Protector Screen - 7'x7' "L" Screen

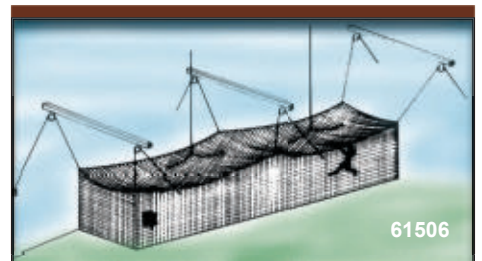

## Rope, Beam Clamp and Pulley Kit

Suspends cage net from ceiling so it can be raised and lowered by hand. Kit includes six heavy-duty 2-1/4" diameter pulleys with beam clamps to attach to overhead I-beams having up to a 9" plate. Also included is 600' of 5/16" polyethylene rope. Wall fastenings not included.

NUMBER	DESCRIPTION
61506	Rope, Beam Clamp and Pulley Kit



*For custom-sized goal nets, please provide the following dimensions:*

1. Height
2. Width
3. Depth at top
4. Depth at bottom

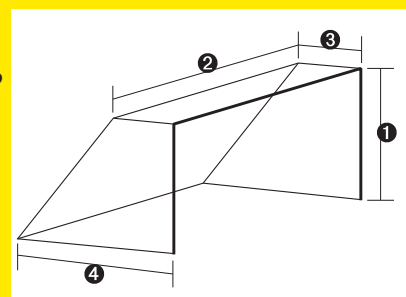

Call 1-800-558-7768 for more information.

## SOCCER GOAL NETS

### Standard Soccer Goal Nets

Carron goal nets are available in durable practice level #21 nylon and rugged competition level #36 nylon which offers an uncompromising 340-pound breaking strength. Nets are made of weather resistant, UV stabilized 4" mesh nylon netting in either black or white. Regulation nets measure 8' high x 24' wide and 4' deep at the top and 10' deep at the bottom. Nets include lacing cords for easy installation. NOTE: These nets can be customized for non-standard goal sizes. **Made in the USA.**

NUMBER	DESCRIPTION
71400	Recreational Soccer Goal Net, #21 nylon, white
71401	Recreational Soccer Goal Net, #21 nylon, black
71405	Competition Soccer Goal Net, #36 nylon, white
71406	Competition Soccer Goal Net, #36 nylon, black



71404

### Junior Soccer Goal Nets

Junior soccer goal nets measure 7' high, 12' wide, and 4' deep at top and bottom. Constructed of white #21 nylon. Includes lacing cords. NOTE: Also available in custom sizes. **Made in the USA.**

NUMBER	DESCRIPTION
71404	Junior Soccer Goal Net, #21 nylon, white

### Polyethylene Soccer Goal Nets

4mm white or orange braided polyethylene heavy duty goal nets are ideal for high level play. Nets measure 8' high, 24' wide, 4' deep at top and 10' deep at bottom. **Imported.**



71503

71504

NUMBER	DESCRIPTION
71503	Competition Soccer Goal Net, 4mm poly, white
71504	Competition Soccer Goal Net, 4mm poly, orange

### Quick-Attach Goal Tape

An attractive, reusable alternative to standard lacing cords, this 1" wide back-to-back hook and loop tape allows for quick, easy net attachment. A roll contains enough material to attach two standard size goal nets. Color white.

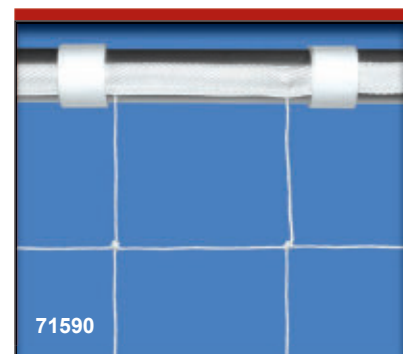

71590

NUMBER	DESCRIPTION
71590	Quick-Attach Goal Tape, 1" wide, white, 27.5 yard roll



## GOAL NETS

### Ice Hockey Goal Nets

Standard practice nets feature #21 nylon cord, 1-1/2" square mesh, one-piece construction. Size is 4' high x 6' wide, 1'4" top depth, 2'5" bottom depth. Complete with lacing cord. **Made in the USA.**

NUMBER	DESCRIPTION
71411	Standard Practice, Ice Hockey Goal Net, white
71412	Standard Practice, Ice Hockey Goal Net, black

### Field Hockey Goal Nets

Carron Net field hockey nets measure 7' high, 12' wide, 4' deep top and bottom. Made from our #21 nylon, 1-1/2" square mesh netting. Complete with our quality lacing cord. **Made in the USA.**

NUMBER	DESCRIPTION
71420	Field Hockey Goal Net, white
71421	Field Hockey Goal Net, black

### Lacrosse Goal Nets

Lacrosse goal nets measure 6' wide, 6' high at front ends and taper back 7' to a point. Roped all around with sides and top gored together for extra durability. Made from our #21 nylon with 1-1/2" mesh, available in white or black. Complete with lacing cords. **Made in the USA.**

NUMBER	DESCRIPTION
71430	Lacrosse Goal Net, white
71431	Lacrosse Goal Net, black

### Standard Water Polo Nets

Water polo nets measure 4' high, 10' wide and 1' deep top and bottom. Made from our #21 nylon with 1-3/4" mesh. Bound on all edges and furnished complete with lacing cords. Flexabar treated black. **Made in the USA.**

NUMBER	DESCRIPTION
71441	Standard Water Polo Net, black

### Official Team Handball Nets

Official size team handball nets are constructed of white #21 nylon 4" mesh and are furnished complete with lacing cords. Nets measure 6'7" high x 10' wide x 2'7" top depth, 3'3" bottom depth. **Made in the USA.**

NUMBER	DESCRIPTION
71450	Team Handball Net, official size

### Broomball Nets

Broomball is played on an ice hockey rink with a volleyball instead of a puck. Goal net measures 6' high, 8' wide, 2' deep at top, 3' deep at bottom. Made of 4" square mesh black nylon netting. **Made in the USA.**

NUMBER	DESCRIPTION
71460	Broomball Net



## BALL/PUCK BARRIER

### Lacrosse and Hockey Barrier Nets

Ideal for lacrosse, field hockey and ice hockey ball/puck containment and spectator protection, our barrier netting is made from durable, low-visibility black 1-1/2" square mesh nylon with tape binding on all edges. Made from UV stabilized and weather treated nylon for both indoor and outdoor use. Made to order in custom sizes.

Lighter duty white 1-1/4" knotless netting is ideal for squash and racquetball court facilities, protecting spectators and keeping balls in play. Nets are tape bound with optional grommets available.



Unless otherwise noted, all Carron Goal Nets are made in our factory in Two Rivers, Wisconsin, and can be customized to fit any goal frame. Contact Carron for a quote.

# ARCHERY NETS



*Archery Nets make excellent heavy duty impact panels for golf and baseball!*



51404



51405

## Nylon Archery Nets

Nylon archery netting is available in any length required, but standard 10' heights only.

NUMBER	DESCRIPTION
51404	Heavy Nylon Archery Net, 10'H, bound all edges with grommets on top on 1' centers.
51405	Economy Nylon Archery Net, 10'H, bound top edge with grommets on 1' centers. Sides and bottom not bound.

**NOTE: THIS NETTING IS INTENDED FOR ARCHERY PRACTICE USING NO MORE THAN A 25-30 LB. BOW WITH WOODEN ARROWS HAVING TARGET POINTS. SUSPEND NET IN FREE HANGING DRAPE.**

# FOOTBALL NETS



100% nylon field goal nets offer premium durability and abrasion resistance. Commonly sized at 40'x40', our sales team will work with you to help determine the right dimensions of these custom manufactured nets for your installation. Surround nets for perimeter ball containment around practice fields are also available.

Carron football practice nets are utilized by coaches and players at the highest levels of the game. These nets install quickly and easily for skill development of specialists in passing, kicking, and centering. Reinforced pockets help improve accuracy for quarterbacks and long snappers. Our football nets are custom made to the most exacting specifications and we specialize in retrofit/replacement nets for existing systems; contact Carron with your requirements.

# BALL CARRIERS, BAGS & PINS, ROPE & TWINE



## Ball Carriers

Made from 100% nylon, our open mesh design allows for easy transport as well as ventilation for wet balls and equipment. Choose heavy-duty knotted construction (#73500) or quality knotless material (#73502). For 8 to 12 soccer balls, footballs or basketballs.

NUMBER	DESCRIPTION
73500	Heavy Duty, knotted – 24"x36"
73502	Standard Duty, knotless – 24"x36"

Quality and durability  
are assured with Carron equipment bags.

For more information, call toll free:

**1-800-558-7768**



## Nylon Stringline, Polypropylene Rope & Nylon Seine Twine

Carron stocks a variety of nylon and polypropylene ropes, twines and stringline for use in construction, installation and repair. All are sold in bulk quantities with cut lengths available for some items. See price list page 22 for details.

NUMBER	APPROX. NEW MATERIAL BREAKING STRENGTH
88700	460 lbs.
88710	210 lbs.
88720	720 lbs.
88722/88730	1130 lbs.
88740	1720 lbs.
88775/88776	210 lbs.
88790/88791	340 lbs.



## Equipment Bags

Equipment bags are the perfect way to keep organized and reduce the chance of lost equipment. Bags are made of knotless nylon netting with heavy drawstring. Accepts heat transfer. Assorted colors. All bags 24"x36".

NUMBER	DESCRIPTION
73510	Equipment bag, white
73512	Equipment bag, blue
73513	Equipment bag, green
73516	Equipment bag, black



## Laundry Bags

Durable white knotless nylon netting with a 3/16" oval mesh makes these bags versatile performers. Drawstring closure.

NUMBER	DESCRIPTION
73521	Laundry bag, 15"x20"
73523	Laundry bag, 20"x30"
73525	Laundry bag, 24"x36"
73527	Laundry bag, 30"x40"



## Laundry Pins

3-1/4" standard and 5" jumbo safety pins are available numbered and unnumbered. Ideal for pool and gym class use. Can be supplied with up to 4 numbers. No letters of the alphabet.

NUMBER	DESCRIPTION
73530	Safety Pin, 3-1/4", unnumbered
73531	Safety Pin, 3-1/4", numbered
73532	Safety Pin, 5", unnumbered
73533	Safety Pin, 5", numbered

# GOLF NETS & ACCESSORIES



70400



*Golf practice nets and cages can be custom sized to fit any area.*



## Golf Driving Barrier Nets

- Helps prevent golfers from hitting directly at buildings, parking lots, pools and other areas.
- Made of 100% nylon for heavy-duty applications. Won't rust or mildew. Available in black or white. Remains flexible even in cool temperatures.
- Strong 3/4" square mesh helps contain direct hit golf shots. Carron sews a tape binding on all edges of each piece for added strength.
- Made-to-order in the sizes you want.

## Indoor Golf Net and Frame

Whether used in schools, golf shops or at the course, Carron golf nets and frames are designed for practice and teaching year 'round. Made with # 252 extra-strong nylon netting with 3/4" sq. mesh. Open on one end and includes baffle, target, 1-1/4" O.D. high strength aluminum frame, rubber mounts and attaching hooks. Size 9'Hx9'Wx9'D. Ships UPS.

NUMBER	DESCRIPTION
70400	Indoor Golf Net and Frame, 9'x9'x9'. Complete
70401	Same as #70400 except for Outdoor use with ground anchors and guy ropes. Complete
70403	Replacement Baffle and Target Unit
70404	Replacement Net for #70400 & #70401, 9'x9'x9'

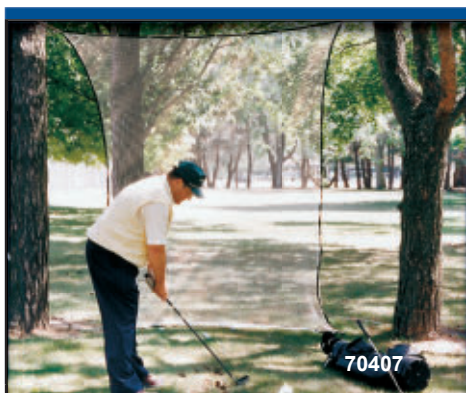

70407

## "Perfect Stroke" Golf Practice Net

Ideal for home backyard use. 10'Hx8'W net can be set up between trees, buildings or garage doors. Made of extra-strong #252 nylon with heavy binding around edges. Complete with grommets along top edge and lacing cord for installation.

NUMBER	DESCRIPTION
70407	"Perfect Stroke" Golf Practice Net 10'Hx8'W



70408

## Nylon Mesh Target

Mesh target constructed of heavy duty archery netting for use with any golf practice net system.

NUMBER	DESCRIPTION
70408	Nylon Mesh Target, 30"x30" with bullseye



## Multi-Player Golf and Archery Cage

Maximize the value of your cage investment with a Carron Multi-Player Combination Cage. Suitable for both golf and baseball, the cages feature zippers on both ends of one long side wall for easy conversion. Cages can also be constructed with archery netting on the back wall for even more versatility.

See page 8 for standard combination cage options and page 17 for more information on custom golf cages and netting systems, or check with Carron Net for specifications and pricing.

# WINDSCREENS, TENNIS COURT DIVIDERS



*Windscreens make great privacy screens for:*

- public spaces
- trash & storage areas
- construction sites



## Windscreens

Designed to minimize visual distractions and reduce air flow into tennis courts, baseball fields, and other fenced areas, Carron windscreens are constructed of either PVC vinyl coated polyester or polypropylene. All screens are open mesh and woven with special sun and weather resistant yarn.

Windscreens will not mildew and will resist abrasion. All edges are reinforced with heavy duty vinyl binding and sewn with two rows of stitching to help assure outstanding performance year after year. Heavy duty solid brass grommets are included on 18" centers on all edges for attachment using our 50 lb. tie wraps (#21502).

**All screens are made to order with a standard height of 6'.** (Screen heights other than 6' are available and are priced by the job. Please call factory for a custom quote.) Options include **Air Vents** (#21494), recommended on 6' or 10' centers, and **Center Reinforcement** (#21495), recommended on screens taller than 6' for mid-point attachment. Both options help alleviate billowing and fence strain and are especially recommended to high wind areas. **Warranty:** 3 years against cracking and peeling when installed with our 50 lb. tie wrap.

Find details about how to measure, order, and install windscreens on our website, [www.carronnet.com](http://www.carronnet.com).

NUMBER	DESCRIPTION
21400	Polypropylene Windscreen, Dark Green
21402	Polyester Windscreen, Dark Green
21420	Polyester Windscreen, Black
21421	Polyester Windscreen, Navy
21422	Polyester Windscreen, Red
21423	Polyester Windscreen, Royal Blue
21424	Polyester Windscreen, Burgundy
21494	Air Vents
21495	Center Reinforcement

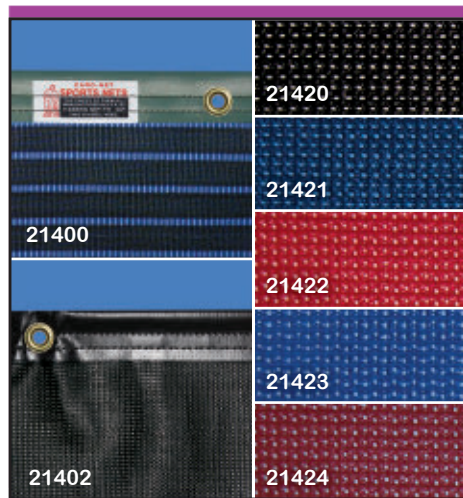

## Tennis Court Divider Nets

Carron court divider nets help keep balls in play and avoid interference with games on other courts. Court dividers are made of sturdy knotted nylon with tape bound edges for extra durability. Select white or black. Grommets on the top edge and an optional 1' vinyl kick panel (as shown above) can be added at an additional cost.

Standard size is 10'x65' and two are required for the standard court. Custom sizes available – call for details and pricing.

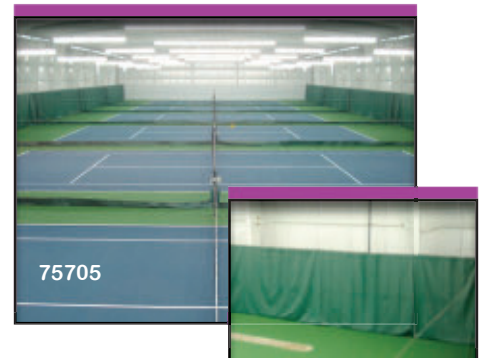

## Vinyl Backdrop Curtain

Vinyl backdrop curtains provide visual and sound barriers around tennis courts. All of the edges on our backdrops are bound with 1-1/2" vinyl for added durability. Backdrop curtains are constructed of 13 oz. solid vinyl, include grommets across the top edge at 1' intervals and are available in white, green or navy blue. Made to order backdrop curtains can be used in conjunction with our court dividers for a complete court containment system.

NUMBER	DESCRIPTION
75705	Backdrop Curtain, 13 oz. vinyl



## Windscreen & Divider Net Hardware

Carron offers a complete assortment of hardware necessary to install court divider nets and windscreens. See page 9 for additional hardware.

NUMBER	DESCRIPTION
21501	Nylon Cord, 100 yds.
21502	Tie Wrap
21533	Snap Hook, to suspend nets
76027	Quick Loop - to attach net to cable
76028	S Hook
76030	Steel Cable, 1/4" dia.
76031	Cable Clamp, to form end loops
76032	Turnbuckle, to tighten cables
76033	Thimble - to reinforce cable loops

# MADE-TO-ORDER NETS



## Scoreboard Nets

Protect your investment with a scoreboard net from Carron. Made with the same tough, long lasting material as our baseball batting cages, scoreboard nets can be made to any size and can be customized with vinyl sleeves on the edges for secure attachment. Contact Carron with your specifications.

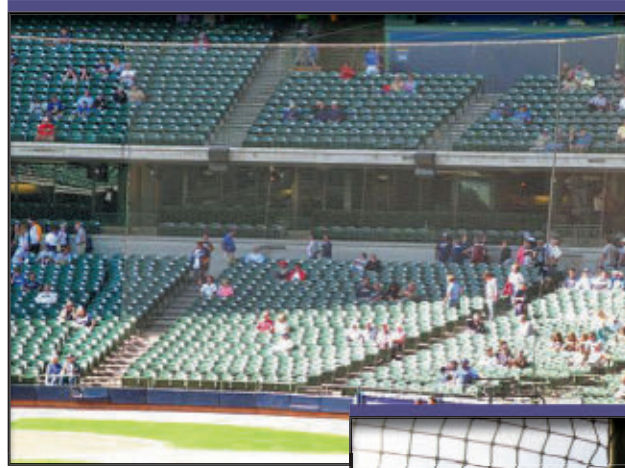

## Baseball Overhead Foul Ball Nets

Help catch high overhead foul balls above chain link backstops and over spectator areas. Weather resistant and UV stabilized knotless nylon has 1-3/4" square mesh size. Complete with tape binding on outside edges of each piece for added strength. Made-to-order to the size and shape you want. Use for baseball or softball.



## Ground Level Backstop Nets

Low level nets for around baseball infields must be of heavy-duty strength to help protect spectators. **Call the Carron factory** – tell us the sizes you need, the level of play and the position on the playing area. We'll make recommendations from our wide selection of material types. All Carron Backstop nets are constructed of heavy duty UV stabilized and weather treated 100% nylon netting for outstanding durability. Nets are made-to-order to fit virtually any application. For odd shaped nets, email or fax a sketch.

**For additional details and specifications on these and other made-to-order nets, see the Custom Netting Selection Guide on page 23. Find more ideas and examples at [www.tinyurl.com/cncustomsports](http://www.tinyurl.com/cncustomsports).**



## Volleyball and Soccer Barrier and Area Nets

For ball containment and spectator protection, whatever the sport, Carron has the right netting for the job. Custom made barrier nets improve practices and keep games moving by keeping balls in play. Player safety is enhanced by eliminating the need to chase balls into hazardous areas like roadways or parking

lots. And spectators (and facility owners) are protected from balls being struck into viewing or seating areas.

Carron Ball Barrier and Area nets are made of durable 100% nylon yet are light weight for easy installation and handling. Our sales staff is ready to help you with the right net for your situation – just give us a call.



# MADE-TO-ORDER NETS

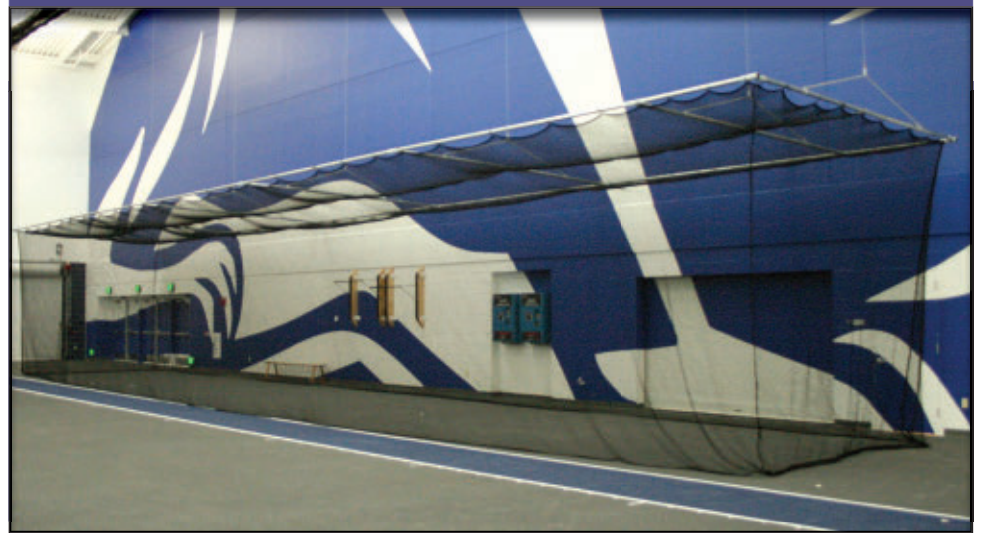

## Custom Baseball Cages and Batting Range Nets

Custom designed baseball cages, enclosure nets and ceiling nets from Carron allow practice centers and commercial batting ranges to take full advantage of the space available while giving players and facilities the protection and functionality they need. Contact Carron for a quote on your new or replacement batting cage and baseball range net requirements.



**CARRON specializes in Made-to-Order Baseball, Golf and Multi-Use Cages and Range Nets. Our expert staff can produce and manufacture a solution to fit virtually any space or configuration request.**



## Custom Golf and Multi-Sport Cages and Net Systems

Schools, golf courses and sports training and rehabilitation centers appreciate the versatility and value of Carron golf and multi-sport cages and net systems. Custom designed for spaces of virtually any size and shape, these cages and net barrier systems add tremendous value by maximizing the utilization of available space. Multi-Sport Cages can also be constructed with archery netting on the back wall for even more strength and flexibility. Contact Carron to discuss your made-to-order golf and multi-sport net system needs.

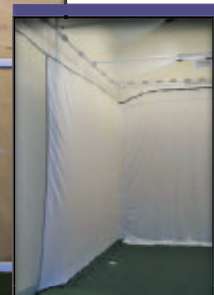

# FIELDHOUSE NETS

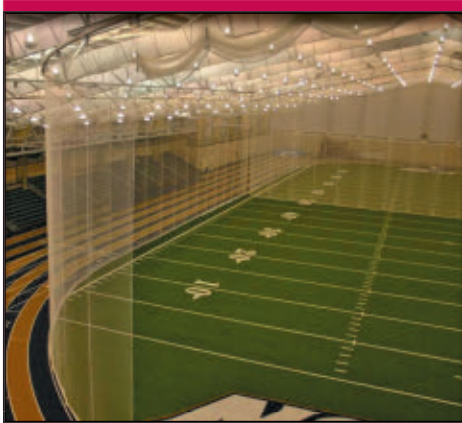

## Fieldhouse Nets

Major colleges and universities use Carron nets in their fieldhouses. The nets can be used to form enclosures large enough for an entire baseball team to practice in at one time. Operable barrier netting allows for multiple field configurations and can separate turf and floor surfaces from perimeter running tracks.

Fieldhouse nets are generally made of 100% nylon mesh or a combination of netting and vinyl. Netting for archery, golf, lacrosse, football or baseball, and throwing cages can be incorporated into a system to optimize use of space. Lift lines are typically added to these nets allowing them to be raised and lowered at the touch of a switch.

Contact the factory for pricing and details including referrals for the specification and design of operable netting systems.

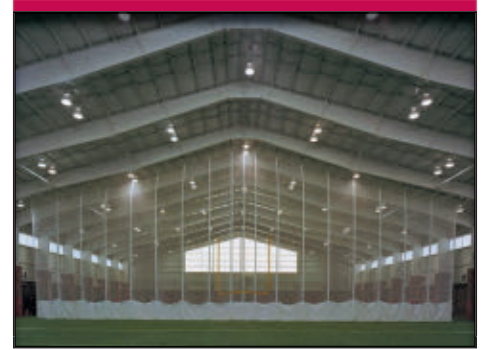

# GYM DIVIDER CURTAINS

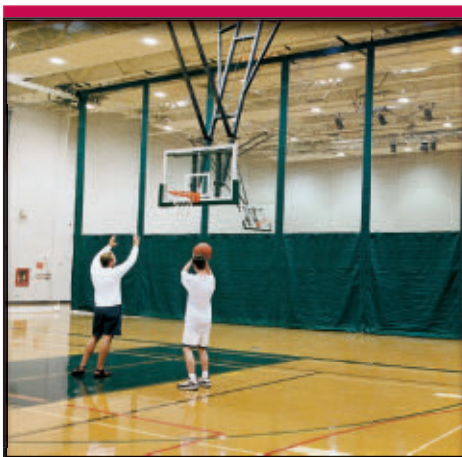

## Gym Divider Curtains

Carron gym divider curtains are built for durability and value. With a variety of constructions, our popular gym divider curtains create opportunities for several sports in the same gym at the same time.

The name "Gym Divider Curtain" usually means two materials are used. The upper part is generally made of smooth hanging scrim mesh to allow light to pass through and air to circulate. The lower portion, typically 8', is constructed of opaque heavy-duty vinyl to provide effective visual and sound separation between multiple activities. Solid vinyl curtains and those incorporating nylon netting in the upper portion are also available. The weight of these curtains means they are most often installed as walk-draw curtains on an aluminum track. Installation

via cable mounting or integration into motorized lift systems may also be options.

Contact the factory for specifications and pricing.



# COURT DIVIDER NETS



## Court Divider Nets

Court Divider Nets are an economical way to divide various activities like volleyball and basketball, allowing coaches and instructors to see through and monitor multiple activities at the same time.

Court Divider Nets are commonly made from 1-3/4" nylon mesh for multi-purpose versatility however each piece is designed to your specifications and can include smaller mesh netting to catch golf or lacrosse balls or larger mesh if only soccer, basketball or volleyball retention is needed. Optional kick panels or weighted bottoms can be added for better ball containment. This product is typically light enough to suspend from a steel cable and draw easily by hand for cost effective installation.

Check with Carron for specifications and pricing. See page 9 for installation hardware.

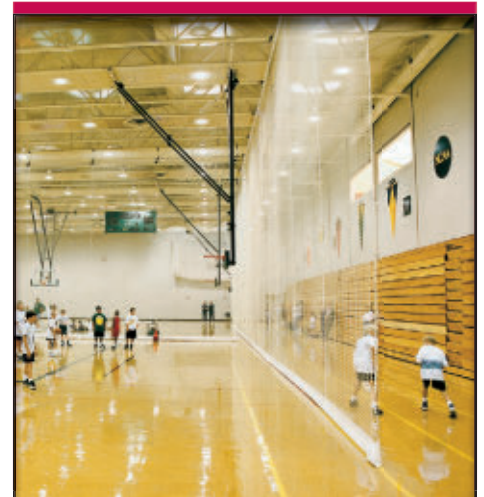

Carron Net gym divider curtains and fieldhouse nets are used at Ball State University, Purdue University, University of Utah, University of Louisville, Boise State University, Brigham Young University, University of Washington, University of Notre Dame, University of Wisconsin, West Point Military Academy, U.S. Air Force Academy, U.S. Coast Guard Academy, and many other outstanding colleges, high schools and elementary schools.

# CUSTOM NETTING SELECTION GUIDE

## Custom Netting Selection Guide

All of these nets can be made to order to your requirements. Price quotes, specifications and additional information can be obtained by contacting Carron Net by phone at 1-800-558-7768, by email at [sales@carronnet.com](mailto:sales@carronnet.com), or by filling out our Sports Netting Request for Quote form on [www.carronnet.com](http://www.carronnet.com).

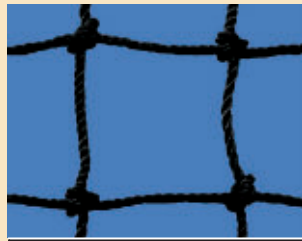

### Knotted Nylon Netting

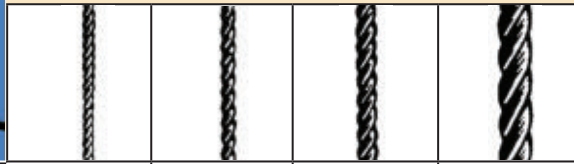

Twine Size (Approximate Diameter)	#12 (1.3mm)	#21 (1.6mm)	#36 (2.5mm)	#96 (4.1mm)
Approximate Tensile Strength	106 lbs.	210 lbs.	340 lbs.	940 lbs.

NUMBER	TWINE SIZE	MESH SIZE	COMMONLY USED FOR:
77701	#21 knotted	1.5"	Hockey and Lacrosse Perimeter and Divider Nets
77702	#21 knotted	1.75"	Baseball and Softball; Multi-Sport Court Dividers, Scoreboard Nets
77703	#21 knotted	4"	Basketball and Volleyball Court Dividers, Soccer Perimeter Nets, Field Goal Nets
77705	#36 knotted	1.75"	Baseball and Softball Backstops, Batting Cages
77708	#12 knotted	1.75"	Tennis Court Dividers, Light-Weight Perimeter and Ball Containment
77709	#12 knotted	4"	Volleyball Perimeter Nets
77712	#36 knotted	4"	Heavy Duty Volleyball and Soccer Perimeter and Divider Nets
77714	#96 knotted	1.75"	Heavy Duty Throwing Cages



### Knotless Nylon Netting

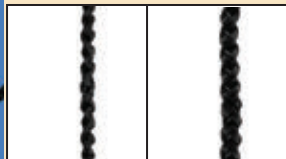

Twine Size (Approximate Diameter)	#252 (1.5mm)	#420 (2mm)
Approximate Tensile Strength	95 lbs.	135 lbs.

*For custom nets it's helpful to know:*

- Size
- Location
- Intended Use

NUMBER	TWINE SIZE	MESH SIZE	COMMONLY USED FOR:
77706	#252 knotless	0.75"	Golf/Multi-Sport Cages, Golf Driving/Barrier Nets, Racquetball/Squash Containment
77707	#252 knotless	1.25"	Hockey Barrier Nets, Light-Weight Barrier Netting, Bird Barrier, Ceiling Protective Nets
77710	#420 knotless	0.75"	Heavy-Weight Golf Nets and Cages, Small Mesh Barrier Nets, Rebounder Nets
77711	#420 knotless	1.75"	Baseball & Softball Foul Ball & Perimeter Nets, Court Dividers



### Standard Binding Options for Netting

Standard binding options for netting include 5/16 inch three strand twisted polypropylene rope continuously spliced to the edges or 1-1/2 inch nylon tape webbing folded over and sewn to form a 3/4 inch hem. Vinyl sleeves, kick panels and chain pockets are also available, and grommets can be inserted in tape or vinyl binding.



**CARRON NET  
COMPANY, INC.**  
*Quality Nets Since 1934*

P.O. Box 177  
Two Rivers, WI 54241-0177

RETURN SERVICE REQUESTED

# CARRONNET.COM

## Your source for nets...on the net!

