

2024

GILL[®]

ATHLETICS



OFFICIAL TRACK & FIELD
EQUIPMENT SUPPLIER

GILLATHLETICS.COM

QUALITY.
COMMITMENT.
INNOVATION.

**MAKING GREAT
EQUIPMENT
ISN'T EASY.**

**INSTALLING
IT SHOULD BE.**

GILL[®]
ATHLETICS

Since 1918, Gill Athletics[®] has been equipping coaches with innovative equipment that elevates the sport and performance of athletes across the globe.

WHAT'S INSIDE



FACILITIES CHECKLIST
Make preparation and evaluations easier!



02 TRACK & FIELD

- 02 Cages
- 12 Circles & Toeboards
- 14 Take-Off Boards & Track Curbing
- 16 Vault Boxes
- 17 Versacom Boxes
- 18 Sand Pit Forms & Covers
- 20 Steeplechase
- 22 Raised Runways
- 23 Ballstops
- 24 Benches & Bleachers
- 26 Seating Shelters & Press Box

28 FOOTBALL & SOCCER

- 28 Football Goals
- 30 Football Padding & Accessories
- 32 Soccer Goals
- 36 Nets & Accessories
- 38 Anchors, Sleeves, & Corner Flags

39 LACROSSE & FIELD HOCKEY

- 39 Lacrosse, Field Hockey, & Futsal Goals

40 BASEBALL

- 40 Pitcher's Mounds & Bases
- 41 Dugouts
- 42 Batting Tunnels & Cage
- 43 Foul Poles
- 44 Baseball Padding
- 46 Windscreens

47 TENNIS

- 47 Tennis Posts & Nets

2024 Litation Sports Group, Inc, Gill Athletics, PowerMax, Pacer are all registered trademarks of Gill Athletics, Inc. Gill Essentials, Maximus, SafetyMax, AGX, Pacer One, PacerFXV, Pacer Composite, Continuum, Fusion, Carbon 1, Hollowood Star, Orbiter, OTE, Tru-Flight, T2-Fiber, Tufmesh Plus, Duralife, Track Wagon are all trademarks of Gill Athletics, Inc. NCAA is a registered trademark of The National Collegiate Athletic Association.

CHECK OUT OUR GREAT **NEW** PRODUCTS

Featured here and online at: www.GILLATHLETICS.com

Prices effective from January 1, 2024 through December 31, 2024



FEATURING

48 BASKETBALL

- 48 Big Shot & Outdoor Competition
- 50 Gooseneck & Vertical Post Systems

52 VOLLEYBALL

- 52 POWR-Sand
- 53 Recreational Outdoor Standards

At Porter Athletic, our mission is to continually improve our processes, products, expertise, and service to create superior opportunities for athletic success.



HAMMER CAGES

Gill hammer and discus cages are engineered to protect athletes, officials, and spectators from errant throws during event competition and practices. Combined with an industry best five-year warranty, Gill Athletics partners with you to keep your facility at the top of its class.



SAFETY.
INGENUITY.
LONGEVITY.

CUSTOMIZABLE CAGES

Pole Color (XX)



**To specify your color selection, use the two-digit number to replace XX in the item number.*



COLISEUM



ALL NEW!

COLISEUM HAMMER/DISCUS CAGE

753100CXXSP	Single or Double Ring	\$49900
75310092	Ground Sleeve Package	\$4285

3-POLE SUPER STRUCTURE

- Improved sightlines for athletes, coaches, judges and spectators
- Decreased upright post damage from high winds
- Reduced installation costs from 3-pole design and retractable door net system



SLIDING NET DOORS

- Eliminates heavy metal door frames, reducing implement damage and dangerous wind sail
- Retractable sliding door net closure system secured by overhead magnet plate and ground anchor key below
- Competition setup is quicker and easier



Upper Magnet Plates



Ground Anchor Key

SINGLE-OPERATOR U-NET FRAME AND WINCH

- Remove hard to reach implements and get back to the completion with ease
- Lower or raise the u-net frame in under 5 minutes with self-provided drill tool
- Exclusive winch and cable routing design engineered for single-person operation without needing heavy equipment



Winch and cable designed for single-person operation



SINGLE OR DOUBLE RING SETUP

ONLY THE GILL COLISEUM OFFERS SINGLE OR DOUBLE RING INSTALLATION AT SAME COST, BECAUSE WE BELIEVE THAT EVERY FACILITY DESERVES TO BE ITS BEST.



OFFICIAL TRACK & FIELD EQUIPMENT SUPPLIER

HAMMER CAGES



CUSTOMIZABLE CAGES

See color charts on page 2 to replace the XX in the item numbers.



BLOCK & TACKLE SAFETY PULLEY SYSTEM

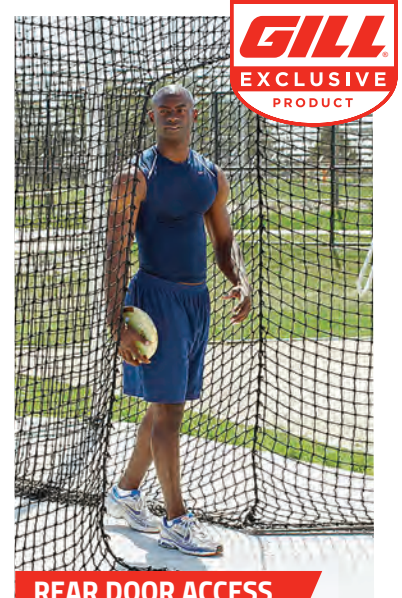

REAR DOOR ACCESS

KEEPS YOUR ATHLETES AWAY FROM THE THROWING SECTOR OF THE FRONT CAGE WHILE INCREASING THE SPEED OF REPETITIONS.

NCAA HAMMER/DISCUS CAGES

- Available in single ring or double ring design
- Poles: 6063-T6 aluminum net poles
- Doors: Cages have 7m tall aluminum doors with galvanized steel door hinge poles.
- Net: Weather treated nylon 6 net with 749 lb break strength
- Cage - Main net: 20' 6" / 6.25m, Door net: 23' / 7m
- All cages include required cage door bracing.
- Ground sleeve kit sold separately
- Meets NCAA Specifications
- 5 Year Warranty



On all Gill Cages
Call for Details.

SINGLE RING CAGE

742110	Cage	\$41845
742110CXX	Cage with Custom Color	\$46035
74211001	Ground Sleeve Kit	\$3468
732103	Optional Barrier Net (8')	\$1170

DOUBLE RING CAGE

742115	Cage	\$45225
742115CXX	Cage with Custom Color	\$49750
74211501	Ground Sleeve Kit	\$4259
732108	Optional Barrier Net (8')	\$1290

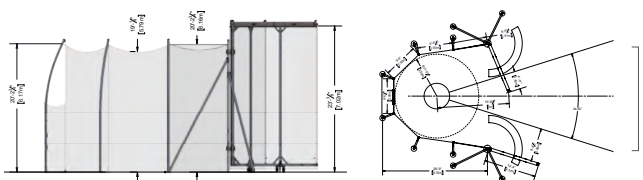

SINGLE RING CAGES

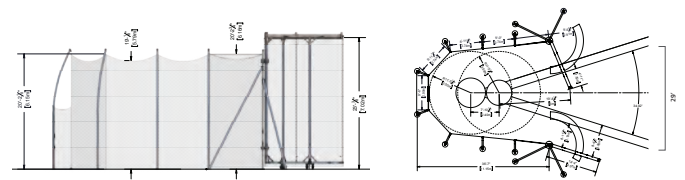

DOUBLE RING CAGES

DISCUS CAGES



732130
OPTIONAL BARRIER NET SHOWN

NCAA ALUMINUM DISCUS CAGE

- Poles: (8) 6063-T6 aluminum net poles
- 16' 7" Net: Weather treated nylon 6 net with 340 lb break strength
- Rear door access net standard
- Rear net support tubes prevent net sag
- 18" hinged net arms secure net at all eight poles
- 36" deep ground sleeves
- **Meets NCAA specifications**
- **5 Year Warranty**

732130	Cage	\$7337
732130CXX	Cage with Custom Color	\$9464
732132	Optional Barrier Net (8')	\$1690

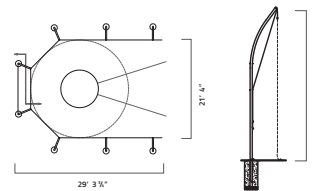

CUSTOMIZABLE



*To specify color with order, use the two-digit number of your color selection to replace XX in the item number.



BRUTUS NCAA DISCUS CAGE

- For high wind areas that need extra strength discus cages
- Made of Hammer Cage strength 4" outside diameter aluminum poles
- **Meets NCAA specifications**
- **5 Year Warranty**

732150	Brutus Cage	\$12550
732150CXX	Brutus Cage, Custom Color	\$15095

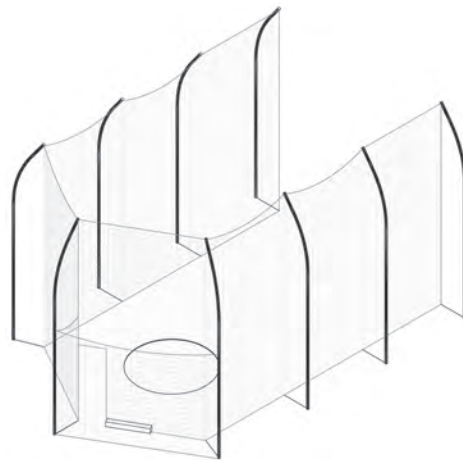

WORLD ATHLETICS ALUMINUM DISCUS CAGE

- Poles: (9) 6063-T6 aluminum net poles
- 6m Net: Weather treated nylon 6 net with 340 lb break strength
- Rear door access net standard
- Rear net support tubes prevent net sag
- 18" hinged net arms secure net at all poles
- **Meets NCAA and World Athletics Specifications**
- **5 Year Warranty**

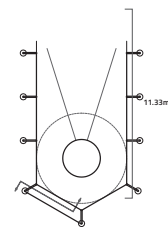

732145	Cage	\$16235
---------------	------	----------------

HIGH SCHOOL DISCUS CAGES



REAR DOOR ACCESS



8010



On all Gill Cages
Call for Details.

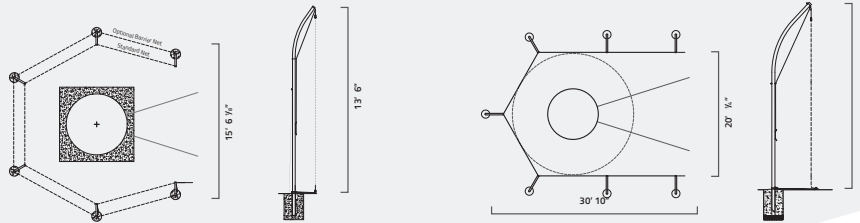

STEEL

- Steel poles: 2 1/2" square A513 (Ultimate-42ksi, Yield-30ksi) with rolled offset for safety
- Nets: 180 lb break strength
- Net height: 13' 6"
- Meets NFHS specifications
- 5 Year Warranty

ALUMINUM

- Aluminum poles: 2 7/8" outside diameter 6063-T6 (Ultimate-30ksi, Yield-25ksi) with rolled offset for safety
- Nets: 180 lb break strength
- Net height: 13' 6"
- Meets NFHS specifications
- 5 Year Warranty

BRUTUS

- For high wind areas that need extra strength discus cages
- Made of Hammer Cage strength 4" outside diameter aluminum poles
- Meets NFHS specifications
- 5 Year Warranty

BEST SELLER!

6 POLE DESIGN		
STEEL	Cage	8030 \$3962
	Barrier Net	80302 \$613
ALUMINUM	Cage	8010 \$4378
	Cage with Custom Color	8010CXX \$5429
	Barrier Net	80102 \$627
BRUTUS	Cage	9010 \$7722
	Cage with Custom Color	9010CXX \$9204
	Barrier Net	90102 \$575

7 POLE DESIGN		
STEEL	Cage	8020 \$4878
	Cage with Custom Color	8020CXX \$6048
	Barrier Net	80202A \$760
ALUMINUM	Cage with Rear Door Access	8021 \$6344
	Cage with Rear Door Access Custom Color	8021CXX \$7389
	Barrier Net with Rear Door Access	80212 \$730
BRUTUS	Cage	9020 \$8986
	Cage with Custom Color	9020CXX \$10240
	Cage with Rear Door Access	9021 \$9526
	Cage with Rear Door Access Custom Color	9021CXX \$10780



COLOR OPTIONS AVAILABLE!

Show Your School Pride with Custom Powder Coating

CUSTOMIZABLE

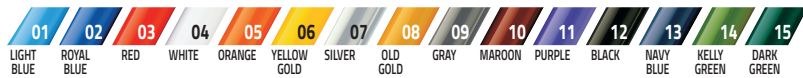

*To specify color with order, use the two-digit number of your color selection to replace XX in the item number.



PRO-DOWN DISCUS CAGE

- Poles: (6) 2 3/8" outside diameter 12 gauge steel poles
- 10' 6" Net: Knotless weather treated nylon net with 180 lb break strength
- Five galvanized steel top rungs eliminate net sag
- **Meets NFHS specifications**
- **5 Year Warranty**

80401 Cage with Ground Sleeves **\$2517**

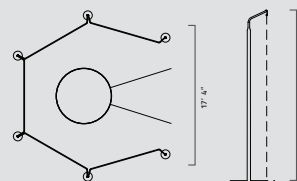

PORTABLE CAGES



HIGH SCHOOL PORTABLE DISCUS CAGE

- Designed for set up and removal as needed
- Poles: (6) 6063-T6 aluminum net poles
- 13' 6" Net: #504 knotless nylon netting with 180 lb break strength
- Base: A500 Grade B steel equipped with wheels. To be weighted with sand or water filled jugs.
- 5 gallon jugs with gray vinyl covers included. Covers available in other colors or with custom graphics for an additional charge.
- **5 Year Warranty**

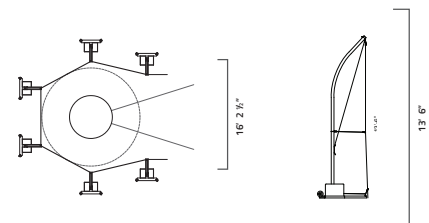

732220	Cage	\$12060
732220CXXYY	Cage with Custom Color	\$13540

CUSTOMIZABLE

*To specify color with order, use the two-digit number of your color selection to replace XX and YY in the item number.

Pole Color (XX)



Vinyl Color (YY)



INTERNATIONAL PORTABLE DISCUS CAGE

- Designed for set up and removal as needed
- Poles: (9) 6063-T6 aluminum net poles
- 5.1m Net: Weather treated #42A knotless net with 340 lb break strength
- Base: A500 Grade B steel equipped with wheels. To be weighted with sand or water filled jugs.
- 5 gallon jugs with gray vinyl covers included. Covers available in other colors or with custom graphics for an additional charge.
- **5 Year Warranty**

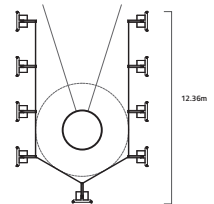

732240	Cage	\$21455
732240CXXYY	Cage with Custom Color	\$23100



NCAA PORTABLE INDOOR CAGE

- Designed for set up and removal as needed
- Poles: (5) 6063-T6 aluminum net poles
- 13' 2" Net: #42A knotless nylon netting with 561 lb break strength
- Doors: repositionable with wired front design for longer life
- Base: A500 Grade B steel equipped with wheels. To be weighted with sand or water filled jugs.
- 5 gallon jugs with gray vinyl covers included. Covers available in other colors or with custom graphics for an additional charge.
- *Meets NCAA specifications*
- *5 Year Warranty*

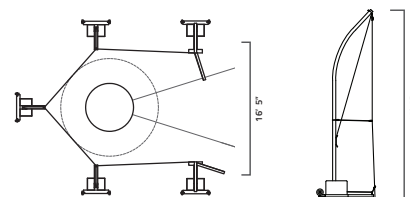

732250	Cage	\$18485
732250CXXYY	Cage with Custom Color	\$20455

5 YEAR WARRANTY On all Gill Cages
Call for Details.

NCAA PORTABLE DISCUS CAGE

- Designed for set up and removal as needed
- Poles: (8) 2 1/2" outside diameter 6063-T6 aluminum net poles
- 16' 7" Net: Weather treated nylon 6 net with 340 lb break strength
- Base: A500 Grade B steel equipped with wheels. To be weighted with sand or water filled jugs.
- 5 gallon jugs with gray vinyl covers included. Covers available in other colors or with custom graphics for an additional charge.
- *Meets NCAA specifications*
- *5 Year Warranty*

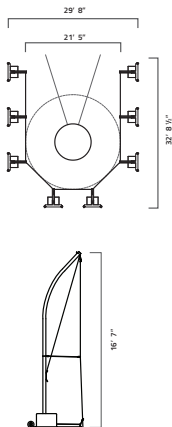

732230	Cage	\$17135
732230CXXYY	Cage with Custom Color	\$18845

PORTABLE SHOT CAGE

- Designed for set up and removal as needed
- Poles: (4) 6063-T6 aluminum net poles
- 13' 6" Net: #42A knotless nylon netting with 180 lb break strength
- Base: A500 Grade B steel equipped with wheels. To be weighted with sand or water filled jugs.
- 5 gallon jugs with gray vinyl covers included. Covers available in other colors or with custom graphics for an additional charge.
- *5 Year Warranty*

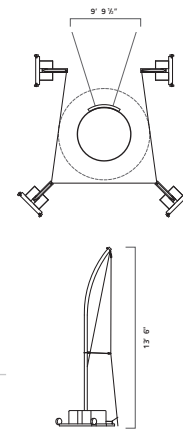

732260	Cage	\$9417
732260CXXYY	Cage with Custom Color	\$10410

SHOT CAGE & ACCESORIES



SHOT CAGE

- Poles: (4) 6063-T6 aluminum or A513 steel
- 13' 6" Net: Weather treated nylon 6 net with 180 lb break strength
- 18" hinged net arms secure net at front two poles with ground stakes used at back poles
- **5 Year Warranty**

805	<i>Steel Cage</i>	\$3458
8050	<i>Aluminum Cage</i>	\$4186
8050CXX	<i>Aluminum Cage with Custom Color</i>	\$4722

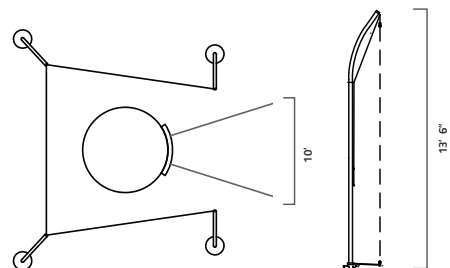

SHOT CAGE



DISCUS SECTOR NET

- Effective at stopping a discus from skipping outside of the sector
- 2' tall by 60' long 320 lb break strength discus net
- Held by 3/8" diameter steel net poles and ground stakes
- Polyethylene net spools included for convenient storage and handling

731135 \$752

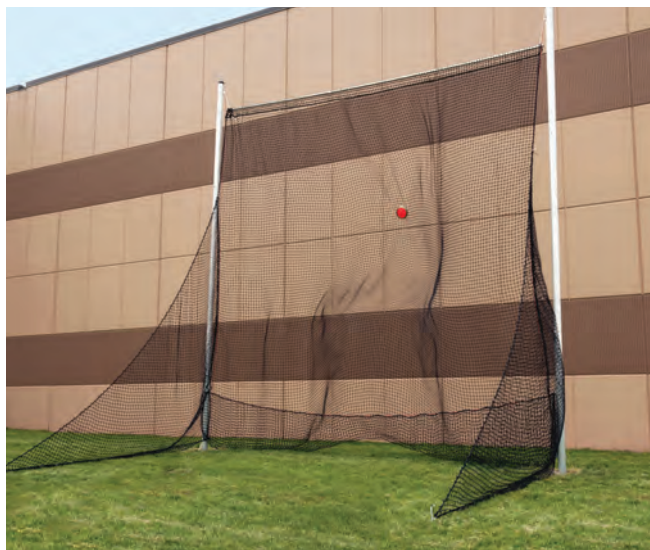

OUTDOOR THROWING NET

- Get the maximum number of reps with the minimal amount of retrieval
- Provides the perfect set up for working on throwing technique for shot put, discus and javelin (weighted balls)
- Bottom of main net has a pocket to catch implements before they hit the ground, preventing damage and making retrieval easier
- Side nets offer additional errant throw protection
- Poles: 4" diameter, 1/8" wall, T6 aluminum tube in 40" deep ground sleeves
- Nets are 749 lb test weather treated knotted nylon
- Main net is 20' x 20'

731300 \$4586



On all Gill Cages
Call for Details.

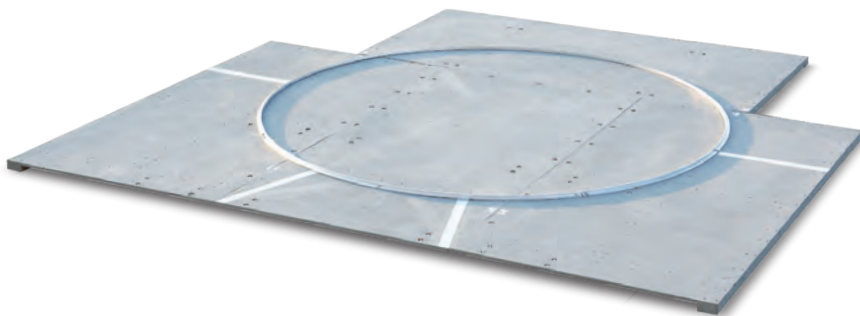

PORTABLE DISCUS PLATFORM

- Wood platform with aluminum circle
- Constructed of 1/2" marine grade plywood with pressure treated 2' x 5' and 2' x 6' lumber
- Platform breaks down into eight pieces for storage space of 8' x 4'
- Weighs in excess of 400 lb
- Gray marine coat finish

3710 \$6204

CIRCLES & TOEBOARDS



BEST SELLER!

ALUMINUM CIRCLES

- Four sections of 1" x 3/4" extruded aluminum angle
- Designed to be cast into concrete
- Discus circle can also be mounted to surface
- Compatible with toeboards 358, 363
- *Meets NFHS, NCAA and World Athletics specifications*

369	Shot/Hammer Circle	\$353
370	Discus Circle	\$370



ALUMINUM CIRCLES WITH 2" ANGLE PROFILE

- Two sections of 2" x 2" extruded aluminum angle
- Designed to be cast into concrete
- Compatible with toeboards 358, 363
- *Meets NFHS, NCAA and World Athletics specifications*

374	Shot/Hammer Circle	\$841
375	Discus Circle	\$877



PROFILE FOR
369, 370 & 372



PROFILE FOR
371 & 373



PROFILE FOR
374 & 375



364 with 373



ALUMINUM SHOT CIRCLE

- Three sections of 1" x 3/4" extruded aluminum angle
- Designed to be mounted on top of concrete surface
- Anchor bolts included
- Compatible with toeboards 359, 364
- *Meets NFHS specifications*

372	\$337
-----	-------



POWDER COATED STEEL DISCUS CIRCLE

- Three sections of 1/4" x 1 1/2" flat powder coated steel
- Designed to be mounted on top of concrete surface
- Anchor bolts included
- *Meets NFHS specifications*

371	\$635
-----	-------



BEST SELLER!

POWDER COATED STEEL SHOT CIRCLE

- Four sections of 1/4" x 1 1/2" flat powder coated steel
- Designed to be mounted on top of concrete surface
- Anchor bolts included
- Compatible with toeboards 359, 364
- *Meets NFHS specifications*

373	\$440
-----	-------



HAMMER CONVERSION CIRCLE





- Converts a discus ring into a hammer ring
- 7 interlocking sections of white PVC plastic
- *Meets NFHS, NCAA and World Athletics specifications, World Athletics certified*

3622	7 Piece System		\$602
------	----------------	---	-------



ALUMINUM CIRCLES WITH CROSS BRACING

- Two sections of 1/4" x 3" extruded aluminum with welded bracing
- Bolt together to maintain form during in-ground installation
- Hardware included
- Compatible with toeboards 358, 363
- Meets NFHS, NCAA and World Athletics specifications, World Athletics certified

366	Shot/Hammer Circle		\$1015
366C04	Shot/Hammer Circle; White		\$1144
367	Discus Circle		\$1011
367C04	Discus Circle; White		\$1139

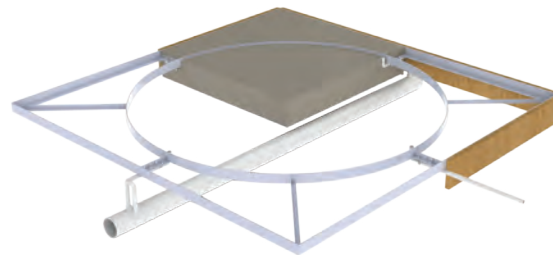

ALUMINUM CIRCLE FORMS

- Four sections of 2" x 3" aluminum angle
- Bolt together form for in-ground installation
- Aluminum exterior bracing creates a strong frame
- Center open for smooth concrete pour and crack-resistant finish
- Inner circle is 1/4" x 3" flat aluminum bar
- Compatible with toeboards 358, 363
- Meets NFHS, NCAA and World Athletics specifications

3741	Shot/Hammer Circle Form	\$4269
3751	Discus Circle Form	\$4872



SYNTHETIC SHOT TOEBOARD FOR DEPRESSED PAD

- Molded low density polyethylene designed for 3/8" depressed surface
- Compatible with circles 366, 369, 374, 3741
- Meets NFHS, NCAA and World Athletics specifications

358 \$505

SYNTHETIC SHOT TOEBOARD FOR LEVEL PAD

- Molded low density polyethylene designed for surface mount shot circles
- Compatible with circles 372, 373
- Meets NFHS specifications

359 \$505



ALUMINUM SHOT TOEBOARD FOR DEPRESSED PAD

- Cast aluminum designed for a 3/8" depressed surface
- Compatible with circles 366, 369, 374, 3741
- Meets NFHS, NCAA and World Athletics specifications, World Athletics certified

363 \$823

ALUMINUM SHOT TOEBOARD FOR LEVEL PAD

- Cast aluminum designed for surface mount shot circles
- Compatible with circles 372, 373
- Meets NFHS specifications

364 \$823



SYNTHETIC PLUGS

- Keeps debris and standing water out of throwing circles
- Constructed of 3/8" thick rubber and made to fit snug inside depressed circles
- Plugs come in sections for easier handling

37001	Shot Circle Plug	\$433
37002	Discus Circle Plug	\$742



SHOWN: 368 Throw Circle (1)
3680 toeboard (1)
All items sold separately

INDOOR SHOT/WEIGHT THROW CIRCLE

- Constructed of 3/8" plywood with steel hinges and handles
- Foldaway handles for easy handling and storage
- Laminated weather proofed marine plywood toeboard (sold separately)
- Optional three piece 3/8" 7-ply birch plywood throwing surface (sold separately, not shown)
- Meets NFHS, NCAA and World Athletics specifications

368	Indoor Shot/Weight Throw Circle	\$1633
3680	Wood Shot Toeboard for Indoor Circle	\$670
3681	Shot Throwing Surface	\$675

TAKE-OFF BOARDS & CURBING

PREPARE FOR TAKE-OFF WITH GILL BOARDS

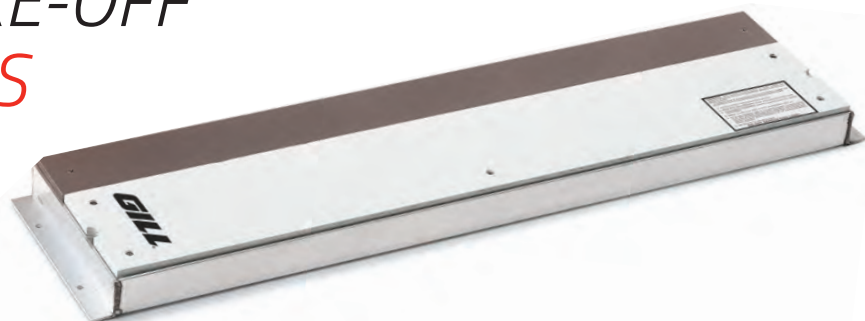

ADJUSTABLE TAKE-OFF BOARD SYSTEMS

With the Gill Adjustable Take-Off Board Systems you get ease of installation, ease of use and dependable peak performance.

Gill Take-Off Board systems are the easiest and fastest boards to install in the market. **Complete system** comes with installation tray, adjustable folded aluminum base, reversible long lasting take-off board and foul board, and functional blanking lid ready to accept track surfacing.

- 8" take-off board and 4" foul board creates 12" system
- Exclusive easy-adjust leveling system for both horizontal and vertical axis
- Composite for longer lifespan
- Composite boards made of Polyboard®, an environmentally friendly, waterproof material that will not split or crack while offering jumpers great grip
- Meets NFHS, NCAA and World Athletics specifications

43505	System with NCAA foul board	\$1565
43515	System with World Athletic foul board	\$1633
43525	System with 12" Take-Off Board	\$726
P435007	Replacement 4" NCAA Foul Board	\$128
P435107	Replacement 4" World Athletics Foul Board	\$153
P435005	Replacement 8" Take-Off Board	\$248
P435205	Replacement 12" Take-Off Board	\$236
439	1 lb Plasticine Brick - Yellow	\$14

ADJUSTABLE 8" TAKE-OFF BOARD SYSTEMS

- Complete system: Installation tray, aluminum leveling board and reversible take-off board
- Composite for longer lifespan
- Composite boards made of Polyboard®, an environmentally friendly, waterproof material that will not split or crack while offering jumpers great grip
- Blanking lid sold separately
- Meets NFHS and NCAA specifications

BEST SELLER!

4445	Complete Standard 8" Take-Off Board System	\$725
44405	Replacement Take-Off Board	\$353
44421	Blanking Lid Assembly	\$462



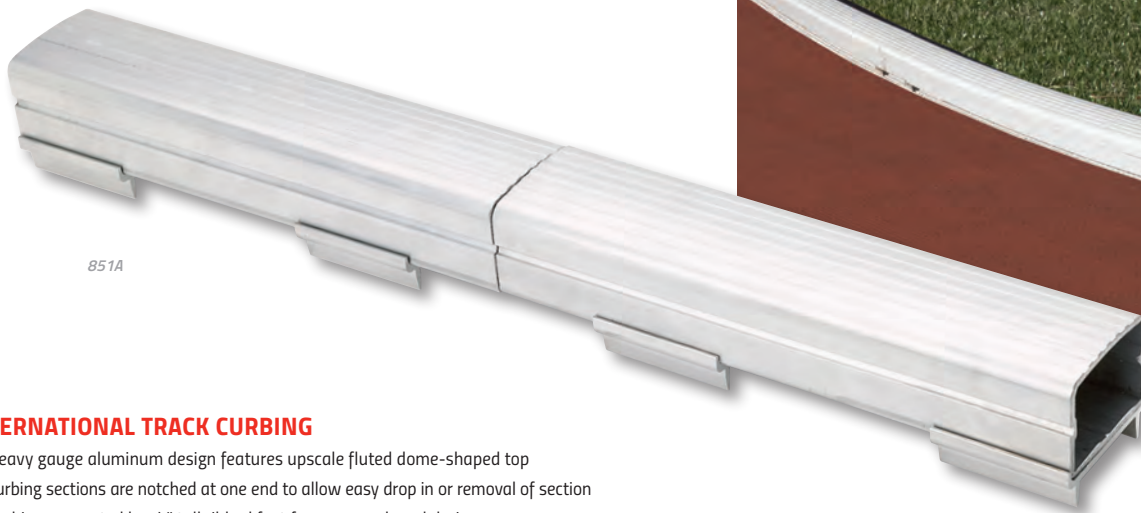

851A



INTERNATIONAL TRACK CURBING

- Heavy gauge aluminum design features upscale fluted dome-shaped top
- Curbing sections are notched at one end to allow easy drop in or removal of section
- Curbing supported by 1/2" tall ribbed feet for unencumbered drainage
- Optional pin kit available to keep curbing from shifting on track
- Permanent installation includes two anchor pins for every 20' section
- Meets NFHS, NCAA and World Athletics specifications, World Athletics certified

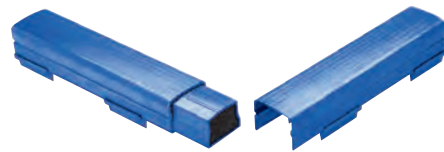

CUSTOMIZABLE

NON-PERMANENT INSTALLATION CURBING

851A	Plain		\$17/ln ft
852P	Powder Coated		\$21/ln ft
851P	Base Pins (12)		\$257/set

PERMANENT INSTALLATION CURBING

853A	Plain		\$18/ln ft
854P	Powder Coated		\$24/ln ft

Powder Coat



*Gray and Black powder coat available in Gloss or Flat



441TS

19.5" TAKE-OFF BOARD SYSTEM

- Complete System: Installation tray, aluminum base board, and reversible take-off board
- Composite for longer lifespan
- Composite boards made of Polyboard®, an environmentally friendly, waterproof material that will not split or crack while offering jumpers great grip
- Meets NFHS specifications

441TS	Complete HS System	\$777
4410S	Replacement 19 1/2" Take-Off Board	\$232



CONVERSION BOARD

- Convert a Gill 19 1/2" take-off board system to an 8" system
- Includes 8" composite take-off board, black vultrac, and baseboard

441C \$483

VAULT BOXES

BEST SELLER!

ALUMINUM VAULT BOX

- Welded aluminum construction
- Reinforced backstop for prolonged life
- Meets NFHS, NCAA and World Athletics specifications, World Athletics certified

502  \$806



ALUMINUM VAULT BOX LID

- Compatible with all Gill vault boxes
- Reinforced with two 1/2" angled vertical supports to prevent sagging
- 50201: Recessed design to accommodate 1/2" (12mm) track surface
- 50202: Flush design with no added track surface

50201 Lid-Recessed Mount **\$708**
 50202 Lid-Flush Mount **\$758**

STEEL VAULT BOX

- Twelve gauge steel with fold and weld construction
- Flanged edges and flared sides for secure installation
- Finished with durable white powder coat
- Meets NFHS, NCAA and World Athletics specifications, World Athletics certified

500  \$673

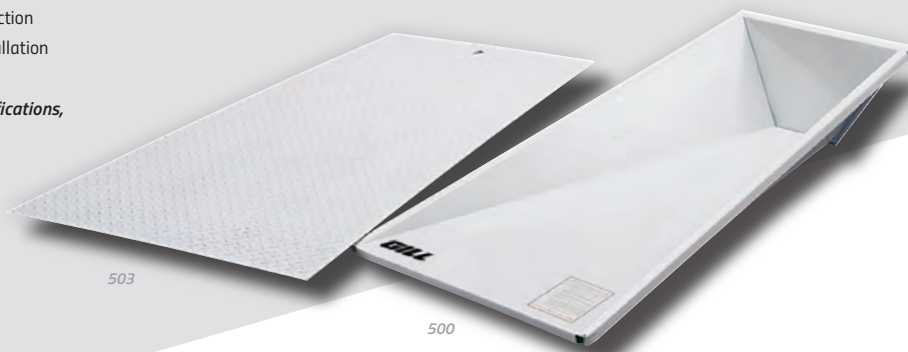

UNIVERSAL VAULT BOX LID

- Compatible with all Gill vault boxes
- Constructed of 11 gauge hot rolled steel
- Features anti-slip designed surface
- Finished with durable white powder coat

503 **\$577**

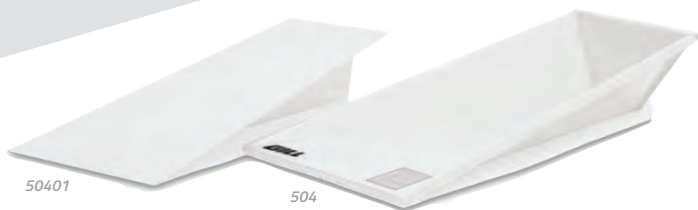

CAST ALUMINUM VAULT BOX

- 100% cast aluminum construction with a wall thickness of 3/8"
- Standard durable white powder coat finish
- Inside corners rounded for unhindered pole rotation
- Guaranteed against cracking or warping
- Meets NFHS, NCAA and World Athletics specifications, World Athletics certified

505 White  **\$1326**



STAINLESS STEEL VAULT BOX AND LID

- Box: Stainless steel alloy fold and weld construction for corrosion resistance
- Lid: 12 gauge 304 stainless steel plate with 2 angled vertical supports to prevent sag
- Lid: Recessed design to accommodate 1/2" (12mm) track surface
- Lid intended for use with stainless steel vault box
- Meets NFHS and NCAA specifications

504 Vault Box **\$1368**
 50401 Vault Box Lid **\$987**



VERSACOM BOXES

CONNECTING IT ALL TOGETHER

The *VersaCom Box* provides a junction for electricity and cable hookups. This box can be put in virtually any location around performance areas of varying surfaces. The open bottom of the VersaCom Box provides adequate drainage and conduit entry, while the hand holes in the cover allow easy access.

- Divider plates in full size version, provided to help keep electrical equipment segregated
- Main box structure is made of 1/4" thick folded aluminum
- Lid is constructed of 1/4" aluminum plates for maximum support and durability

The *VersaCom Box - Synthetic Version* allows material to be bonded or poured onto the top of the lid to match the surrounding surface.

The *VersaCom Box - Turf Version* features a supplied aluminum top to allow artificial turf to be glued on the jobsite, and is tethered to the box. This top is reinforced with multiple aluminum plates for maximum strength and durability. Factory installed turf infill retention brushes keep infill out of the box.



VERSACOM RISER *(Sold separately)*

The VersaCom Riser has the same dimensions as a full-size VersaCom Box. The riser attaches to the bottom creating a box that is twice as deep.

F90010 *Versacom Riser* **\$874**

VERSACOM BOXES		FULL SIZE 30" L x 18" W x 14" D		HALF SIZE 15" L x 18" W x 14" D	
SYNTHETIC VERSIONS	<i>Synthetic</i>	F910	\$1737	F930	\$1128
	<i>Turf</i>	F960	\$1789	F970	\$1180

SAND PIT FORMS & COVERS

Sand pit forms hold more than just sand, they hold value.

With four different options of Sand Catcher locations and two practical Sand Catcher Cover options, you can design the horizontal jump facility that will perfectly meet your needs.

No matter which combination you choose; with the Gill Functional-Form, you can rest assured it's the finest product (with the easiest installation) available.

Choose from one of two Sand Catcher Cover systems: traditional grate and mat or Gill (exclusive) Recessed Lid. When you consider the main function of a Sand Catcher system is not to catch sand but to store it, the Recessed Lid system is rapidly becoming the choice of facilities worldwide, as it is designed to receive track surfacing to match your track facility. When coupled with the 730148 Aluminum Sand Pit Cover, a complete logical design emerges for your world class jumps facility.

Choose from one of four sand catcher locations: no sides, two sides, two sides and back, or all four sides. Choosing Sand Catchers on the sides will cut unnecessary costs and eliminate potential trip hazards, providing more than ample storage space for overflow sand.

FORM WITH RECESSED CATCHERS



FORM WITH GRATE & MAT CATCHERS



FORM WITH NO CATCHERS

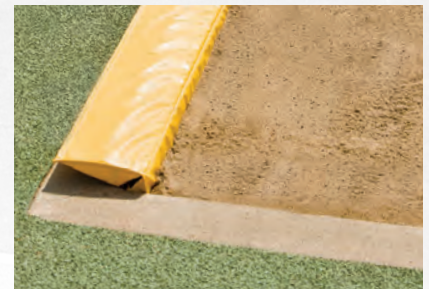

730 Perimeter Padding sold separately

4 SIDES	25' L	F46225 \$23380
	28' L	F46228 \$25355
	31' L	F46231 \$32835
3 SIDES	24' L	F46124 \$26270
	27' L	F46127 \$20365
	30' L	F46130 \$22730
2 SIDES	23' L	F46023 \$16295
	26' L	F46026 \$18665
	29' L	F46029 \$20105

4 SIDES	25' L	F44225 \$22330
	28' L	F44228 \$24960
	31' L	F44231 \$25760
3 SIDES	24' L	F44124 \$18560
	27' L	F44127 \$19440
	30' L	F44130 \$21555
2 SIDES	23' L	F44023 \$14720
	26' L	F44026 \$16425
	29' L	F44029 \$17085

LEDGE	23' L	F42023 \$6448
	26' L	F42026 \$7108
	29' L	F42029 \$7364

ALL FORMS ARE 9' 8" WIDE

FAST INSTALLATION

**Track surface not included

PERIMETER PADDING SYSTEM

- Greatly reduce possibility of injury caused by impact with sand pit edging
- Modular pads install on any sand pit quickly and conveniently
- Critical location of pads is along sides of sand pit
- Each pad is 36" long

730

\$189



RECESSED SAND CATCHER COVER PANELS

- Designed for 1/2" (12mm) track surface
- Constructed of 1/8" aluminum sheet metal
- Standard unit measures 18" x 36" and requires a ledge around perimeter to rest on
- Special lengths available between 18" and 35" long

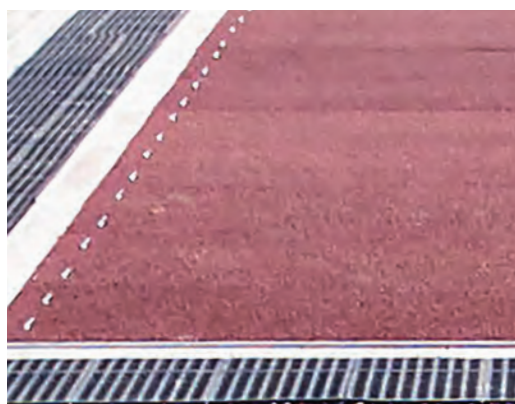

LJ/TJ ALUMINUM SAND PIT COVER

- Each panel made from 9.5" x 1.75" x .125" aluminum planking framed with 2 3/8" x 1 1/2" x 3/16" aluminum angle
- Panels have four flush mount handles
- Recessed design for 1/2" (12mm) track surface

730148 \$50/sq ft



BALLASTED LJ/TJ SAND PIT COVERS

- Exclusive Vipol Matrix mesh material or solid vinyl polyester
- Anchoring system: Vinyl wrapped galvanized steel chain perimeter
- Ballasted pit covers are custom sized and sold by the square foot (no returns)
- Optional 5' x 5' multi-color graphic available
- Dimension certification form must be submitted with order

493680	Mesh Vinyl	\$8.75/sq ft
493682	Solid Vinyl	\$8.75/sq ft
4936	Graphic Option	\$1034

COLORS



MORE COLORS AVAILABLE!
Additional charge applies.

READY-FIT ALUMINUM SAND PIT COVERS

F44023C	23' Cover	\$10605
F44124C	24' Cover	\$11080
F44225C	25' Cover	\$11560
F44026C	26' Cover	\$11990
F44127C	27' Cover	\$12470
F44228C	28' Cover	\$12945
F44029C	29' Cover	\$13370
F44130C	30' Cover	\$13845
F44231C	31' Cover	\$14320

LJ/TJ SAND PIT COVERS

- Keep your sand pit clean and dry with solid vinyl sand pit covers or choose mesh if rain is not an issue
- Constructed of vinyl coated woven polyester
- Anchoring system: Bags filled with sand placed in pouches to weigh cover down
- Optional 5' x 5' multi-color graphic available
- Graphic worksheet and vector artwork must be provided
- Additional colors available for additional charge

730147	Gray Mesh 11' 9" x 25' 6"	\$1308
730147L	Gray Mesh 11' 9" x 31' 6"	\$1912
730147V	Gray Vinyl 11' 9" x 25' 6"	\$1528
730147VL	Gray Vinyl 11' 9" x 31' 6"	\$1984
9453	Graphic Option	\$795

STEEPLECHASE



SAVE MONEY WITH VALUEPACKS!

VALUEPACK - SURFACE MOUNT

Package includes:

- F600 Steeplechase Water Jump Form
- 740144 Steeplechase Water Jump Barrier-surface mount version

VPF600 \$12960

FUNCTIONAL-FORM STEEPLECHASE WATER JUMP SYSTEMS

Gill Athletics has greatly simplified the installation of steeplechase water jump reservoirs with these Functional-Form systems. With the Functional-Form, installation precision is ensured to meet NFHS, NCAA and World Athletics specifications. Structure is fabricated of specially folded 1/8" aluminum to maximize strength and includes designed inner wall supports that allow the concrete to flow through and set evenly.

- F600: Compatible with 740144 water jump barrier
- F610: Compatible with 740134 water jump barrier
- Both models compatible with 730146 aluminum water jump cover
- Both models come standard with valve option: installed front wall valve to be connected with an outgoing pipe to the drain source
- *Meets NFHS, NCAA and World Athletics specifications*

F600 *Surface Mount Form* **\$9079**

F610 *Ground Sleeve Form* **\$9079**

VALUEPACK - GROUND SLEEVE

Package includes:

- F610 Steeplechase Water Jump Form with integrated ground sleeves
- 740134 Steeplechase Water Jump Barrier-ground sleeve version

VPF610 \$12385

WATER JUMP COVERS

- Each panel made from 9.5" x 1.75" x .125" aluminum planking framed with heavy duty aluminum angle
- Panels have four flush mount handles
- Recessed design for 1/2" (12mm) track surface
- Understructure supported with 4" x 2" aluminum beams

730146 \$13540



730146, 740144, 730150CXXSP

STEEPLECHASE WATER JUMP BARRIERS

- Barrier beam is 4" x 4" square steel tubing with synthetic track material
- Pull pin design makes barrier height change a snap
- Welded gusset adds needed strength support to the beam
- Adjustable to three heights: 30", 33", 36"
- Aluminum water jump barrier seal available
- *Meets NFHS, NCAA and World Athletics specifications*
- *Surface mount barrier is World Athletics certified*
- *5 Year Limited Warranty*

740134 *Water Jump Barrier with Ground Sleeves* **\$3520**

740144 *Water Jump Barrier with Surface Mount* **\$4103**

730150CXX *Aluminum Barrier Seal* **\$1638**

730150CXXSP *Aluminum Barrier Seal w/ Graphics* **\$1966**

COLORS



MESH WATER JUMP BARRIER SEALS

- Add design to your steeplechase water jump
- Lightweight design will ease water barrier height change

740145204SP *White Mesh with Graphics* **\$730**





OFFICIAL EQUIPMENT SUPPLIER TO THE
NCAA TRACK & FIELD CHAMPIONSHIPS



BEST SELLER!

STEEPLECHASE BARRIER WITH DROP DOWN WHEELS

- 5" x 5" Barrier beam is constructed with aluminum extrusion and synthetic track material
- Wheels easily set and retract with foot engaged levers
- Pin pull design allows for simple barrier height adjustment
- Welded gusset adds needed strength support to the beam
- Adjustable to three heights: 30", 33", 36"
- Meets NFHS, NCAA and World Athletics Specs/Certification
- 5 Year Limited Warranty

740150	1 x 5m Barriers, 3 x 4m (4)		\$19220/set
740150131	4m Barrier; 13' Width		\$4852/ea
740150161	5m Barrier; 16' 5" Width		\$5283/ea

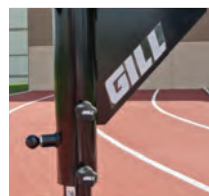

STEEPLECHASE BARRIER

- 5" x 5" Barrier beam is constructed with aluminum extrusion and synthetic track material
- Pin pull design allows for simple barrier height adjustment
- Welded gusset adds needed strength support to the beam
- Adjustable to three heights: 30", 33", 36"
- Optional wheel kit for manual addition of wheels for transportation
- Meets NFHS, NCAA and World Athletics Specs/Certification
- 5 Year Limited Warranty



On all Steeplechase Barriers
Call for Details.



740140	1 x 5m Barriers, 3 x 4m (4)		\$13700/set
740140131	4m Barrier; 13' Width		\$3416/ea
740140161	5m Barrier; 16' 5" Width		\$3874/ea
74014050	Wheels (4)		\$290/set



6' TRAINING BARRIER

740140061	6' Training Steeplechase Barrier		\$2740
740150061	6' Training Barrier w/Drop Down Wheels		\$4545

RAISED RUNWAYS

In the past, these types of runway systems have been priced upwards to \$75k! You can now have this product at a fraction of that price. The Gill Raised Runway allows for the flexibility to design runways that will accommodate the pole vault, long jump and triple jump for all levels of competition and practice.

The basic unit is an 8' x 4' general runway section. Specialized sections incorporate a vault box or take-off board trays and blanking lids. The construction of each section is welded aluminum, with ½" plywood decking. Track surfacing is not included, so you can have your preference on surfacing.

Adjunct products for the Raised Runway include the Soft Shell Sand Pit Form for the long and triple jump (sand not included), and a pole vault pit elevating system.

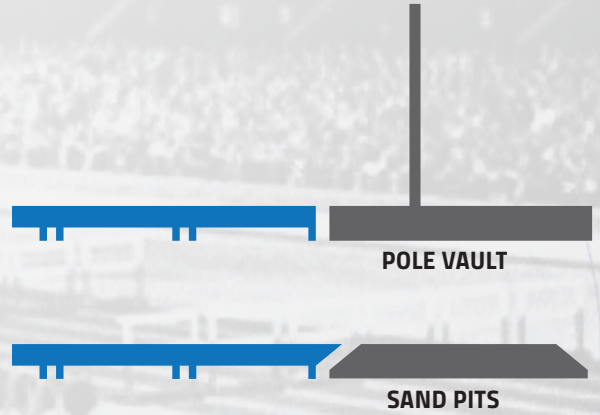

CALL TODAY!

LET US HELP YOU PIECE TOGETHER THE **RAISED RUNWAY** SYSTEM THAT BEST FITS YOUR NEEDS.

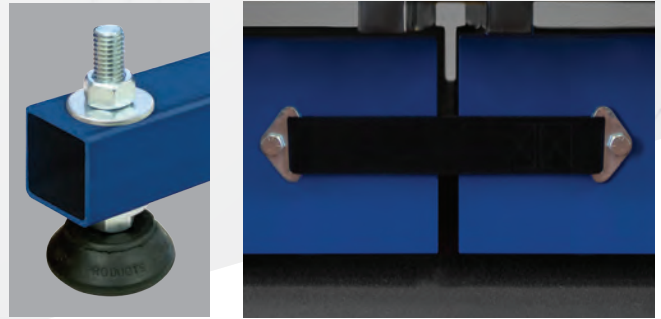

CUSTOMIZABLE RUNWAY

Powder Coat

- | | | | | | | | |
|------------------|------------------|--------------|-------------|-----------------|-------------------|------------------|----------------|
| 01
LIGHT BLUE | 02
ROYAL BLUE | 03
RED | 04
WHITE | 05
ORANGE | 06
YELLOW GOLD | 07
SILVER | 08
OLD GOLD |
| 09
GRAY | 10
MAROON | 11
PURPLE | 12
BLACK | 13
NAVY BLUE | 14
KELLY GREEN | 15
DARK GREEN | |

*Gray and Black powder coat available in Gloss or Flat

BALLSTOPS



10' - 40' TALL BALLSTOP SYSTEMS

- 10' use 2" Sch 40 2-3/8" aluminum tube-36# Netting
- 12', 15' and 20' use 4" diameter, 1/8" wall aluminum tube - #36 Netting
- 25' and 30' use 6" Sch 40 aluminum tube - #36 Netting
- 35' and 40' use 6" Sch 40 steel tube - #36 Netting
- All Poles 10'-40' have a vertical support cable for additional net support
- Ground sleeves included
- All poles are powder coated in architectural black
- 5 Year Warranty

HERE FOR YOU!

CALL TODAY AND WE'LL HELP GET THE **BALLSTOP** SYSTEM THAT BEST FITS YOUR FACILITY.



On all Gill Ballstops
Call for Details.



BALLSTOP NET RELEASE CLIPS

Designed to drop the protective netting in high winds before any pole or hardware failure occurs.

- Marine Grade HDPE material
- Designed to break and drop nets in high winds, 20' and shorter or 25' and taller
- Sold in pack of 10 clips

739000 20' Ballstops and shorter **\$145**

739001 25' Ballstops and taller **\$145**

PORTABLE BALLSTOP SYSTEM

The Ballstop Systems were designed to be set up and removed as needed.

- 10' use 2" Sch 40 2-3/8" aluminum tube-36# Netting
- Poles have a vertical support cable for additional net support
- The portable system uses a platform base with wheels that is weighted down by four 5 gallon jugs (included)
- All poles are now powder coated in architectural black.
- 5 Year Warranty



BENCHES & BLEACHERS



ALUMINUM BENCHES

Portable Benches

72081	8' Bench, Aluminum Finish	\$445
72081CXX	8' Bench, Powder Coat	\$486
72161	16' Bench, Aluminum Finish	\$665
72161CXX	16' Bench, Powder Coat	\$721

Stationary (Ground Sleeve) Benches

72082	8' Bench, Aluminum Finish	\$331
72082CXX	8' Bench, Powder Coat	\$364
72162	16' Bench, Aluminum Finish	\$512
72162CXX	16' Bench, Powder Coat	\$556

CUSTOMIZABLE

Powder Coat



*To specify color with order, use the two-digit number of your color selection to replace XX in the item number.

ALUMINUM BENCHES WITH BACKREST

Portable Benches

74041C15	4' Tennis Bench, Powder Coat	\$780
73081	8' Bench, Aluminum Finish	\$680
73081CXX	8' Bench, Powder Coat	\$750
73161	16' Bench, Aluminum Finish	\$1139
73161CXX	16' Bench, Powder Coat	\$1258

Stationary (Ground Sleeve) Benches

73082	8' Bench, Aluminum Finish	\$660
73082CXX	8' Bench, Powder Coat	\$719
73162	16' Bench, Aluminum Finish	\$1139
73162CXX	16' Bench, Powder Coat	\$1248





**ALUMINUM STATIONARY
OUTDOOR BLEACHERS**

- Non-Slip, Grooved Type Top Surface With Reinforcing Ribs
- 10" Wide Aluminum Alloy Planks
- Galvanized Structural Steel Support Frames
- Plank Ends Are Fitted With Die-Cut Formed Caps

381085	<i>8' Long, 5 Row</i>	\$2505
381165	<i>16' Long, 5 Row</i>	\$4210



ALUMINUM TIP & ROLL INDOOR BLEACHERS

Set up seating wherever you need it. When spectator viewing space is at a minimum, the Tip & Roll seating system is a must. The hardy bleachers use the same sturdy construction as the outdoor models.

- Non-Marking 4" Swivel Casters
- Bi-Directional Model Ideal Between Two Fields
- Easy To Transport

379283	<i>8' Long, 3 Row</i>	\$2295
379163	<i>16' Long, 3 Row</i>	\$3780



SHELTERS



OFFICIAL EQUIPMENT SUPPLIER TO THE
NCAA TRACK & FIELD CHAMPIONSHIPS

PORTABLE TRACK SHELTER

Steel frame is mounted on swivel casters. 360 degree seating surrounds a center storage shelf. Roof frame is constructed of aluminum bracing with architectural gray powder coat. Canopy is tensioned with a one-piece vinyl wrap. Custom color and graphic application available on canopy top.

54240CXXSP *Portable Track Shelter w/ Graphics* **\$6443**



CUSTOMIZABLE

Vinyl



*To specify color with order, use the two-digit number of your color selection to replace XX in the item number.



SCORER PRESS TOWER

- Aluminum and steel frame 7.8' x 16.3' x 11.2'
- White UV-resistant, polycarbonate top panels
- No-flat wheels with brakes for smooth mobility
- Galvanized steel tow hitch and ball coupler
- Leveling system allows for use on uneven surfaces
- Diamond plate aluminum floor and ladder rungs
- Available in 15 colors
- 12 year warranty

54900CXX *Scorer Press Tower* **\$27170**



ELITE CUSTOM SHELTER

- 7' high by 5'2" deep team shelter
- All-aluminum frame construction
- Bleacher length choice 9', 12', 15', 24'
- No-flat 12" zinc plated casters for easy mobility
- Frame available in 15 powdercoat colors
- Custom graphics available on side panels
- 12 year warranty

362009CXX	<i>9' Bench Length</i>	\$12695
362012CXX	<i>12' Bench Length</i>	\$14165
362015CXX	<i>15' Bench Length</i>	\$15550
362024CXX	<i>24' Bench Length</i>	\$19560



GILL
ATHLETICS

MORE THAN TRACK & FIELD

*Your preferred source for track & field equipment is also your source for football, soccer, baseball and more.
Quality. Commitment. Innovation.*

FOOTBALL • SOCCER • BASEBALL • TENNIS • WINDSCREENS • PADS

FOOTBALL GOALS



STEEL GOALS

4½" OD gooseneck, 3½" OD crossbar and 2¾" OD uprights.

8' Gooseneck allows a soccer goal to fit beneath the high school crossbar.

All ground sleeves and mounting plates sold separately

HIGH SCHOOL

(23' 4" BETWEEN UPRIGHTS)

6' OFFSET	Ground Sleeve	Plate Mount
20' Uprights	FB36120CXX \$10925/pr	FB46120CXX \$13030/pr
8' OFFSET	Ground Sleeve	Plate Mount
20' Uprights	FB38120CXX \$10925/pr	FB48120CXX \$13030/pr

Gill football goals feature a 'No-Field Drill' installation. Both our steel and aluminum goals are engineered to decrease installation time while increasing safety no matter which you choose.

ALUMINUM GOALS

6½" Gooseneck and crossbar with 4" diameter uprights

8' Gooseneck allows a soccer goal to fit beneath the crossbar

All ground sleeves and mounting plates sold separately

HIGH SCHOOL

(23' 4" BETWEEN UPRIGHTS)

6' OFFSET	Ground Sleeve	Plate Mount
20' Uprights	FB16120CXX \$15130/pr	FB26120CXX \$17475/pr
30' Uprights	FB16130CXX \$16075/pr	FB26130CXX \$18425/pr
Spliced 30' Uprights	FB16131CXX \$18010/pr	FB26131CXX \$20410/pr
Spliced 35' Uprights	FB16135CXX \$18380/pr	FB26135CXX \$20735/pr
8' OFFSET	Ground Sleeve	Plate Mount
20' Uprights	FB18120CXX \$15130/pr	FB28120CXX \$17475/pr
30' Uprights	FB18130CXX \$16075/pr	FB28130CXX \$18425/pr
Spliced 30' Uprights	FB18131CXX \$18010/pr	FB28131CXX \$20410/pr
Spliced 35' Uprights	FB18135CXX \$18380/pr	FB28135CXX \$20735/pr

GOAL COLORS



*To specify color with order, use the two-digit number of your color selection to replace XX in the item number.



GROUND SLEEVE

MOUNTING PLATE

GROUND SLEEVES

Every football goal will require a ground sleeve or mounting plate for installation. All sleeves and plates are sold individually.

- F39901** For Aluminum Goals **\$508/ea**
- F39902** For Steel Goals **\$473/ea**

MOUNTING PLATE

- F35550** Mounting Plate **\$866/ea**

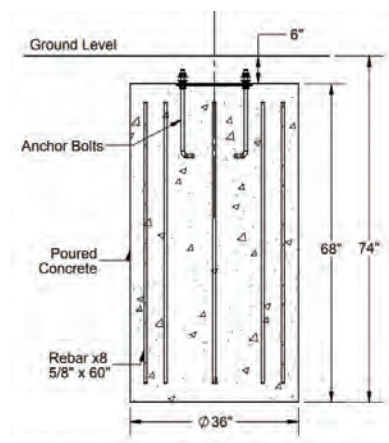
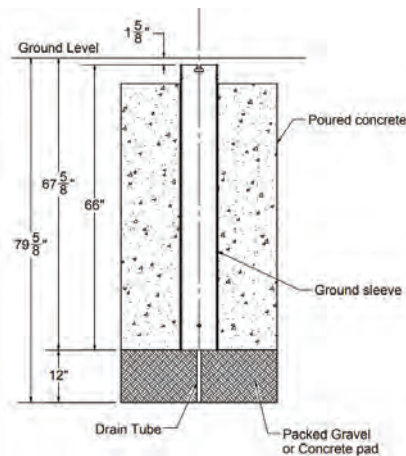

FOOTBALL PADDING



LACE-UP PAD



DELUXE PAD



GOOSENECK PAD

LACE-UP PAD

Lace-Up Pads: 1½" thick polyurethane foam pad is 6' tall and fits 3½"-4½" pole diameters. 15 oz. vinyl 5'10" x 12" cover available in 14 colors; specify color with order. Lace closure.

000690XX	6' Pad, Lace-Up Pad Closure	\$336/ea
000690XXSP	6' Pad, Lace-Up Pad Closure with Graphics	\$399/ea

DELUXE PAD

Deluxe Pad: 4" thick polyurethane foam pad is 6' tall and fits 4½"-5¾" pole diameters. 15 oz vinyl cover available in 14 colors. Hook and loop closure. Graphics available with new pad.

001870XX	6' Pad, Hook-And-Loop Closure	\$622/ea
001870XXSP	6' Pad, Hook-And-Loop Closure, With Graphics	\$708/ea

CUSTOMIZABLE



*To specify color with order, use the two-digit number of your color selection to replace XX in the item number.

GOOSENECK PAD

Gooseneck Pad: 6" thick polyurethane padding covered in tough 15oz vinyl available in 14 colors (specify color when ordering).

F302XX	6' Gooseneck Pads, Hook-And-Loop Closure	\$1628/pr
F302XXSP	6' Gooseneck Pads with Graphics	\$1763/pr



FOOTBALL PYLONS

- Bottom Weighted markers (require no additional hardware to install)
- Meets NCAA & NFHS Requirements

296801	Pylons (set of 4)	\$87
---------------	-------------------	-------------

ACCESSORIES



FOOTBALL STOPPER SET

This football stopper set is designed to keep fans and bystanders safe from field goals and extra points. Installed behind each football goal, the 35'h x 50'w net can be raised and lowered with ease during a game or stationary during practice. Set includes two stoppers (1 for each goal).

F350 **\$13160**

ACCESS FRAME KIT

This kit provides effortless access to the base of a football goal for easy installation, adjustment, or removal. The access frame creates a uniform, seamless surface around the goal post for improved safety. Kit includes access frame and pole plugs that fit around a goal post with a diameter up to 6 3/4". For safety, a solid plug is strongly recommended for use when the goal post is removed. Each goal post requires one kit. Blank metal allows track surface application for continuity in D-Zones.

F304	Access Kit - Turf Covered	\$734
F304S	Access Kit - Blank Metal	\$639
F30410	Access Frame Only	\$442
F3042	Pole Plugs - Turf Covered	\$399
F3043	Pole Plugs - PVC	\$463
F3044	Pole Plugs - Blank Metal	\$231
F3045	Solid Plugs - Turf Covered	\$307
F3046	Solid Plugs - PVC	\$181
F3047	Solid Plugs - Blank Metal	\$277



CROSSOVER ZONE®

For everyday use, the Crossover zone is lighter and easier to handle than other conveyor belt rubber systems. Protects against steel tipped cleats, shoes and even grounds equipment wheels, yet rain drains through. Black geotextile with gold edging for safety and durability.

493667	7.5' x 30' Zone	\$730
493668	7.5' x 40' Zone	\$873
493663	15' x 30' Zone	\$1036
493664	15' x 40' Zone	\$1258
493651	15' x 75' Zone	\$1903
493652	15' x 100' Zone	\$2288
493653	15' x 125' Zone	\$2829

U90 WORLD CUP & PORTABLE GOALS



upper90¹

MEETS FIFA, NCAA, & NFHS

U90 STATIONARY WORLD CUP GOAL

8' x 24' goals made of 4" round aluminum construction in a white powder coat finish.

492200 *World Cup Goal Package* **\$5907**

INCLUDED: 8' x 24' Goals (pair), White Hexagon Nets (pair), Ground Sleeves (4), Back Post Net Supports (4), Back Post Ground Sleeves (4), Net Tie Down Stakes (16)

GET CLASSIC **WORLD CUP** STYLE ANYWHERE!



Upper90[®]

MEETS FIFA, NCAA, & NFHS

U90 PORTABLE WORLD CUP GOAL

Portable 8' x 24' goals made of 4" round aluminum construction that comes in a white powder coated finish with custom powder coated back posts. Goal nests under 8' football goal posts. Sold in pairs.

493000CXX World Cup Portable Goal Package **\$9864**

INCLUDED: 8' x 24' Goals (pair), White Hexagon Nets (pair), 4 Easy-To-Engage Wheel Assemblies, Auger Anchor Kit, Back Bar with Weights



CUSTOMIZABLE

01	02	03	04	05	06	07	08	09	10	11	12	13	14	15
ROYAL BLUE	RED	WHITE	ORANGE	YELLOW GOLD	SILVER	OLD GOLD	GRAY	MAROON	PURPLE	BLACK	NAVY BLUE	KELLY GREEN	DAP GR [®]	

*To specify color with order, use the two-digit number of your color selection to replace XX in the item number.



U90 PREMIER PORTABLE GOAL



Upper90¹

MEETS FIFA, NCAA, & NFHS

U90 PREMIER PORTABLE GOAL

Portable goals made of 4" round aluminum construction that comes in a white powder coated finish. Equipped with European backstays and signature Upper90 lift and roll wheels. Nesting goal fits in front of 6' offset football goal.

587200	8' x 24' Premier Package	\$9703
587202	8' x 24' Premier Nesting Package	\$9584
587203	6' 6" x 18' 6" Premier Package	\$8897

*INCLUDED: Goals (pair), 3mm x 5" Square Braid Net / White (pair), Quick Clip Net System
4 Easy-To-Engage Wheel Assemblies, Auger Anchor Kit, Back Bar with Weights*

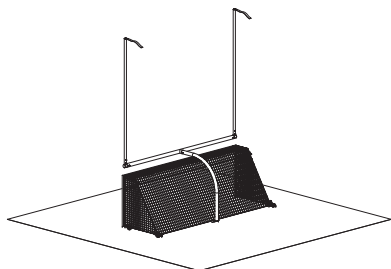

Shown with 587202 8'x24' Premier Nesting Package



CHAMPIONSHIP & ESSENTIAL GOALS



MEETS FIFA, NCAA, & NFHS

U90 CHAMPIONSHIP PORTABLE GOAL

Portable goals made of 4" round aluminum construction that comes in a white powder coated finish. Equipped with European backstays and signature Upper90 lift and roll wheels. A variety of net styles are available.

48713 8'x24' Championship Package **\$7379**
 INCLUDED: 8' x 24' Goals (pair), Nets (pair), Transport Kit (pair)
 Auger Anchor Kit, Back Bar with Weights

487200 8' x 24' Championship Goals **\$5996/pr**
 INCLUDED: 8' x 24' Goals (pair), Nets (pair) Auger Anchor Kit, Rear Spreader Tube Kit.

Accessories **00293000** Transport Kit **\$844/ea**



NETS & ACCESSORIES



SQUARE NYLON BRAIDED NETTING

For use with goals with backstays

00491618	6'-6"	\$97/pr
49166186	6'-6" X 18'-6" X 6'-6"	\$200/pr
00491824	8' X 24' X 8'	\$357/pr

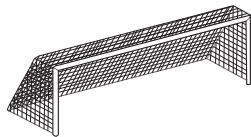

HEXAGON NYLON BRAIDED NETTING

For use with goals with back posts

49282401	8' X 24' X 6'6"	\$581
----------	-----------------	-------

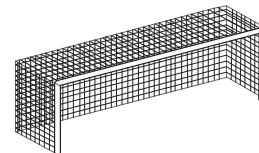

BUNGEE NET TENSIONERS

Elastic material with plastic knot cover. Set of 25 fit one goal.

54402	\$11
-------	------



REPLACEMENT NET ATTACHMENT CLIP

Set of 50 net clips fit any porter aluminum goal. Safe and simple clips slide into a continuous slot.

484050	\$105
--------	-------



VELCRO® NET FASTENER

Reusable 2-sided velcro roll (15' l x 1" w). One roll fits one net to an 8' x 24' goal.

4715	\$41
------	------



8" SOCCER NET TIE-DOWN STAKES

Set of 8 heavy formed steel stakes. Zinc-plated material minimizes corrosion. Not to be used as goal anchors.

00418080	\$38
----------	------



ANCHOR BAG

Designed to anchor a soccer goal on any surface. Add your own sand and place them on the base frame of the goal. Place anchor bags in the back corners, to provide the most counter-balance.

54401 **\$26/ea**



BACK POST NET SUPPORT

For use stationary goals. Ground sleeve required. Back post is 2 3/8" OD steel with pulley.

00422040	Set of 4 Back Posts	\$1165
00402000	Ground Sleeve (1)	\$206



TRANSPORT KIT

Each kit includes two 12" diameter pneumatic wheels to easily roll any of our portable soccer goals.

00293000 **\$844**



UPRIGHT PADS

Round wrap around lace up pad for round soccer goals.

000690XX Round Pad **\$336/ea**



EUROPEAN BACKSTAYS

Backstays are 3' deep and fit the Upper90 Premier Portable goals (set of 4).

292300 **\$645**

ANCHORS & SLEEVES

AUGER ANCHOR KIT

Auger-type goal anchor kit (set of 4) is required on existing portable soccer goals for maximum player safety. Wraps around backstay tubing and through auger to prevent tipping.

00298170 \$222



GOAL ANCHORING SYSTEM

Latches around the base of football goal gooseneck and connects to the rear spreader bar of goal. Simple system guards against soccer goal tip over. Compatible with 487200 Championship Goals and Aluminum Football Goals

F155 \$523/pr



GROUND SLEEVE ANCHOR

A ground sleeve option for securing portable goals in turf fields. Featuring a small 4½" footprint and a flexible top that compresses with surrounding turf on impact. Chain link wraps anchor pin inside ground sleeve and rear spreader tube on surface to secure goal in place. Padlocks included. Cap may be covered with turf for uniform appearance.

00406 \$337



OUTDOOR GROUND SLEEVES

In-ground/sleeve style soccer goals are the best choice for providing maximum safety! Sold individually.

00402000 Fits 2¾" Back Posts \$206

00404000 Fits 4" Round Goals \$210



5' FIELD FLAGS

54601 Set of 8, Numbered 1-8, Steel Peg \$25

54603 Set of 4 Corner Flags, 7" Rubber Base \$20

REPLACEMENT WARNING LABELS

LABL00552000 Portable

LABL00553000 Stationary



FREE UPON REQUEST

FIELD HOCKEY



PRACTICE FUTSAL GOAL

Portable 6'7" x 9'10" goals made of 3" round aluminum powder coated finish. Includes 4mm white nets and easy to engage wheels. Sold as pair.

54515 **\$1846/pr**



COMPETITION FIELD HOCKEY GOAL

Portable 7'H x 12'W x 4'D goals made of 2"x2" steel tubing that comes in a white powder coated finish. Includes 18" bottom boards and weather-treated 1-1/2" square mesh nets made of #21 black nylon. Meets all requirements for competition.

260100 **\$4420/pr**

SOLD SEPARATELY

260101 Transport System (Fits 1 Goal) **\$384/ea**

Includes (2) pneumatic tires and support bracket assemblies. Attaches to back of a single field hockey goal so user can tip and roll the goal on and off the field.

BASEBALL



MAJOR LEAGUE HOME PLATE

Sturdy hard rubber base designed to withstand the battering of cleats. Runners sliding into home won't dislodge the base thanks to the included anchor, while the beveled edges prevent cleats or uniforms from snagging during the slide.

33250 \$196



MAJOR LEAGUE SHOCK ABSORBING BASES

Cushioned base designed to help reduce injury. Durable, one-piece molded rubber base with no metal parts. Removable white center post for easy storage and replacement. Does not include anchors.

33251 Set of 3 Bases \$348

33253 White Center Posts (3) \$55



DOUBLE FIRST BASE

Helps prevent collisions and serious cleat injury. Helps umpires vision on close calls. Double anchoring sleeves/anchors for extra stability and prevents turns.

33212 \$187



4-WAY PITCHERS RUBBER

Molded rubber construction with inner support tubing lasts through tough games and practices. Can be periodically rotated for use over multiple seasons.

33252 Pitchers Rubber \$208

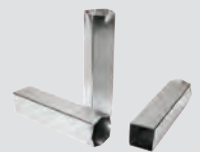

GROUND ANCHOR SET

33254 Ground Anchors (3) \$85



BASE PLUGS

33255 Base Plugs (3) \$71



CANTILEVER DUGOUT

8' tall x 8' wide cantilever dugout with 24" rear offset. Bolt together design with a 120 MPH wind rating and 50 lb/sq ft snow rating. Choose from 15 different powder coat colors. Roof only available in white.

340812CXX	12' Long	\$4753
340824CXX	24' Long	\$8211
340836CXX	36' Long	\$11660
340848CXX	48' Long	\$15125

**CUSTOMIZABLE
DUGOUTS**

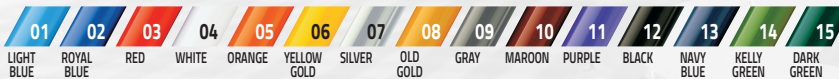

*To specify color with order, use the two-digit number of your color selection to replace XX in the item number.

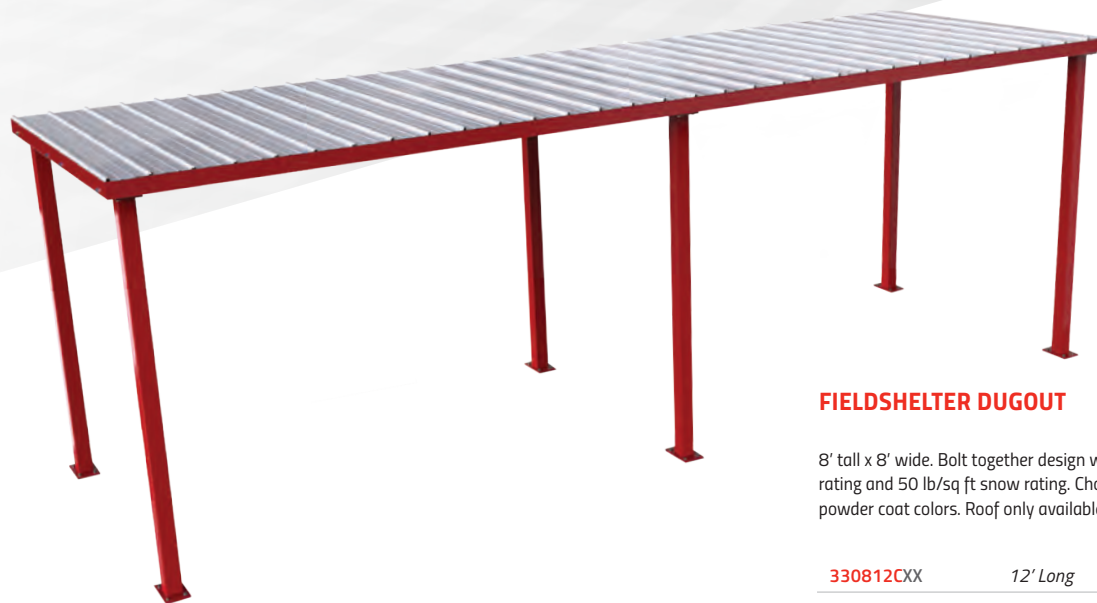

FIELD SHELTER DUGOUT

8' tall x 8' wide. Bolt together design with a 120 MPH wind rating and 50 lb/sq ft snow rating. Choose from 15 different powder coat colors. Roof only available in white.

330812CXX	12' Long	\$3661
330824CXX	24' Long	\$6297
330836CXX	36' Long	\$8944
330848CXX	48' Long	\$11565

BASEBALL



BATTING TUNNELS

Single

330155 55' Long **\$13200**

330175 75' Long **\$14440**

Double

330255 55' Long **\$21655**

330275 75' Long **\$23910**

Triple

330355 55' Long **\$29885**

330375 75' Long **\$33595**

- Heavy duty 8 $\frac{3}{8}$ " OD steel poles
- Premium architectural black powder coating
- Four steel pole, open-cage design creates an open cage and hanging net so balls stop without rebound
- $\frac{1}{4}$ " galvanized aircraft quality cable
- Easy turnbuckle adjustment, and quick clip (snap hook) net attachment
- #36 weather treated knotted netting, machine sewn stitched rope borders, top center rib line for height control, and double door entry on one end



BATTING CAGES

The cage is 10' high x 12' wide and available in either a 50' or 70' length. Netting is constructed of a durable, black UV resistant weather treated nylon with a 1 $\frac{3}{4}$ " #420 square mesh. The net is supported by 2 $\frac{1}{8}$ " diameter aluminum uprights to provide lightweight, yet extremely rigid supports. Uprights extend into either outdoor or indoor sleeves and are furnished with ropes, pulleys, and rope cleats to provide ease of set up of the entire system without the use of ladders.

330150	50' Cage (8 Sleeves Required)	\$4131
330170	70' Cage (10 Sleeves Required)	\$5373
802025	Outdoor Ground Sleeve (1)	\$58

BASEBALL FOUL POLES

Baseball foul poles extend the foul lines vertically to provide a visual indication of the fair versus foul territory. Made of two sections that bolt together in the field, constructed of heavy-duty steel pipe. Available in 5 heights, sold in pairs in a durable powder coat finish.

- 8' wing panels
- Available in optic yellow (18), white (04) and optic orange (24)
- GSMIF (ground sleeve miss installation forgiveness)

In-Ground/Sleeved:

334012CXX	12', No Wings	\$400/pr
334016CXX	16', 1 Wing	\$2366/pr
334024CXX	24', 2 Wings	\$6765/pr
334032CXX	32', 3 Wings	\$9953/pr
334040CXX	40', 4 Wings	\$14505/pr

Ground Sleeves

00402000	For 12'	\$206/ea
F39903	For 16'	\$330/ea
F39902	For 24'	\$473/ea
F39901	For 32'	\$508/ea
F39901	For 40'	\$508/ea

Surface Mount

334116CXX	16', 1 Wing	\$3661/pr
334124CXX	24', 2 Wing	\$8003/pr
334132CXX	32', 3 Wings	\$11435/pr
334140CXX	40', 4 Wings	\$16075/pr



*To specify color with order, use the two-digit number of your color selection to replace XX in the item number.

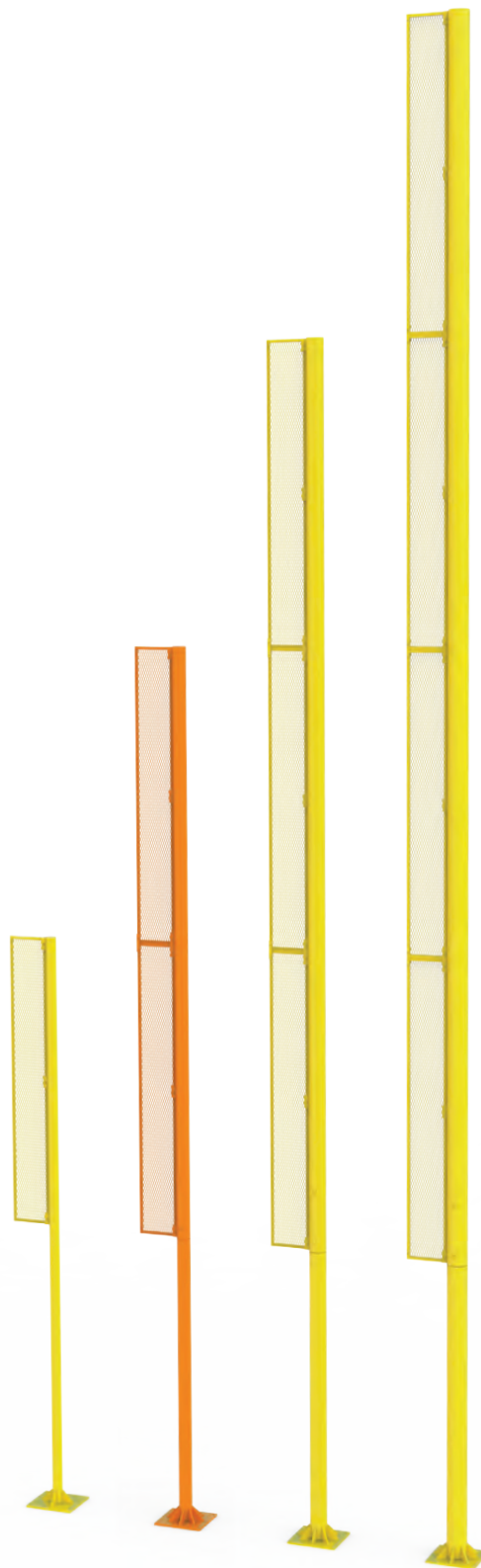
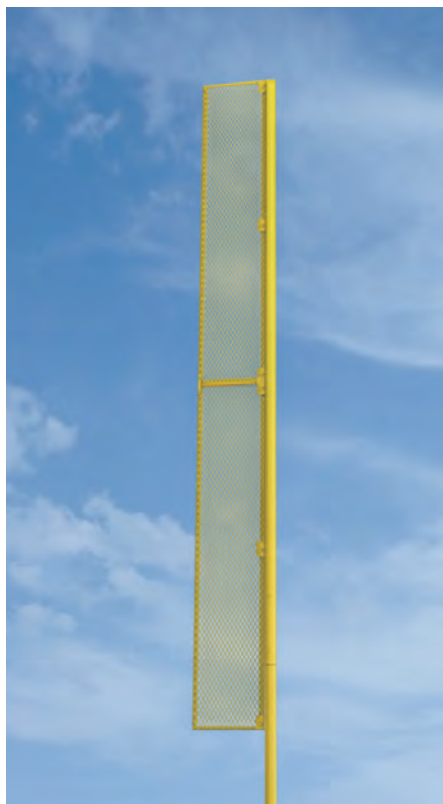

OUTDOOR PADDING



Custom Graphics Available for Essentials and Elite Pads (Additional Charge) Add SP to end of item #

ESSENTIALS OUTDOOR WALL & FENCE PADS

2" thick polyurethane foam core attached to 1/2" thick, sealed, water resistant PVC. Pad meets the minimum ASTM F2440 impact standard specification. Each panel uses 15oz UV treated vinyl. **WALL PAD** panels have an unwrapped back. **FENCE PAD** panels are completely wrapped, using threaded wood inserts to allow for chain link fence attachment. All pads can also be installed using "Z" clips allowing seasonal removal, repair, or replacement. All Pads built to your specified dimensions with a maximum width of 4'. Custom Graphics available (add SP to end of item #).

WALL PADS	FENCE PADS		
36202XX	36402XX	4' x 2' Pad	\$202
9036202XX	9036402XX	Custom Size - 4' x 2' or less	\$215
36204XX	36404XX	4' x 4' Pad	\$335
9036204XX	9036404XX	Custom Size - 4' x 4' or less	\$372
36206XX	36406XX	4' x 6' Pad	\$531
9036206XX	9036406XX	Custom Size - 4' x 6' or less	\$586
36208XX	36408XX	4' x 8' Pad	\$592
9036208XX	9036408XX	Custom Size - 4' x 8' or less	\$652

Essentials Vinyl



Use the two-digit number of your color selection to replace XX in the item number.

PADDING ATTACH CLIPS

347100	6' Wall Attachment Z-Clip	\$20
3650	Under 4'x6' Fence Attachment Clip	\$67
3651	Over 4'x6' Fence Attachment Clip	\$96

ELITE OUTDOOR WALL & FENCE PADS

3" thick polyurethane foam core attached to 1/2" thick, sealed, water resistant PVC. Pad meets the minimum ASTM F2440 impact standard specification. Each panel uses 19oz UV treated vinyl. **WALL PAD** panels have an unwrapped back. **FENCE PAD** panels are completely wrapped, using threaded wood inserts to allow for chain link fence attachment. All pads can also be installed using "Z" clips allowing seasonal removal, repair, or replacement. All Pads built to your specified dimensions with a maximum width of 4'. Custom Graphics available (add SP to end of item #).

WALL PADS	FENCE PADS		
36302XX	36502XX	4' x 2' Pad	\$259
9036302XX	9036502XX	Custom Size - 4' x 2' or less	\$293
36304XX	36504XX	4' x 4' Pad	\$417
9036304XX	9036504XX	Custom Size - 4' x 4' or less	\$463
36306XX	36506XX	4' x 6' Pad	\$644
9036306XX	9036506XX	Custom Size - 4' x 6' or less	\$709
36308XX	36508XX	4' x 8' Pad	\$732
9036308XX	9036508XX	Custom Size - 4' x 8' or less	\$806

Elite Vinyl



Use the two-digit number of your color selection to replace XX in the item number.

WINDSCREENS



TUFFY® WINDSCREENS

Screens are made with an exclusive durable mesh fabric of tightly woven micro-fibers: it's virtually tear-proof. Tuffy® is the only windscreen finished with double-needle lock stitching, eliminating the thread unraveling problem of traditional windscreens. Includes 5 year warranty, available in 20 colors. Grommets every 12". 78% Shading. Custom Printing available - call for details.

912015	Tuffy® 5' Windscreen, Per Linear Foot	\$7.00/ln ft
912016	Tuffy® 6' Windscreen, Per Linear Foot	\$7.50/ln ft
912019	Tuffy® 9' Windscreen, Per Linear Foot	\$14.00/ln ft



RAIL PADDING

8' long pads are polyethylene foam with colored vinyl coating. UV, weather and rot resistant pads are pre-slit for easy installation. Fits over any 2 1/8" diameter or less pipe.

35912	Black	\$68
-------	-------	------

TENNIS



ESSENTIALS TENNIS POSTS

Competition tennis posts with fully enclosed net tensioning mechanism. Outdoor system includes ground sleeves. Indoor system requires purchase of floor sleeves. 3.5" OD high strength steel posts with heavy duty dark green outdoor powder coating. Net and accessories are sold separately.

884	<i>Outdoor Posts</i>	\$670/pr
884A	<i>Indoor Posts</i>	\$639/pr

ELITE TENNIS POSTS

Competition tennis posts with fully enclosed net tensioning mechanism. 4" square high strength aluminum posts with heavy duty outdoor powder coating. Post cap with tamper resistant hardware to prevent vandalism or use by unauthorized individuals. Includes one winch post and one tie-off post. Ground sleeves, net, and accessories all sold separately.

885	<i>Dark Green Posts</i>	\$1012/pr
------------	-------------------------	------------------

POST SLEEVES SOLD SEPARATELY

00444000	<i>Outdoor Ground Sleeve, Square Cover</i>	\$313
00885800	<i>Indoor Elite Floor Sleeve, Chrome Cover</i>	\$357
00885900	<i>Indoor Elite Floor Sleeve, Brass Cover</i>	\$327
00872100	<i>Indoor Essentials Floor Sleeve, Chrome Cover</i>	\$240
00872200	<i>Indoor Essentials Floor Sleeve, Brass Cover</i>	\$240

SOLD SEPARATELY

2235	<i>Tennis Net 42' x 39"</i>	\$399
00885500	<i>Singles Stick Net Support</i>	\$180
02238000	<i>Center Tie Down Strap</i>	\$48
02239000	<i>Outdoor Center Strap Anchor</i>	\$45
02238100	<i>Indoor Center Strap Anchor</i>	\$83
02991340	<i>Indoor Tennis Net 34' x 39"</i>	\$556
010970XX	<i>Indoor Tennis Pads</i>	\$512



TENNIS BENCH

See page 24

GILL
ATHLETICS



CHAMPIONSHIP ATMOSPHERE DESERVES CHAMPIONSHIP EQUIPMENT.

The best athletes. The biggest meets. Shared and relived by champions everywhere. Prepare your event how it deserves to be experienced and remembered – by using athletic equipment trusted at the highest levels of competition.

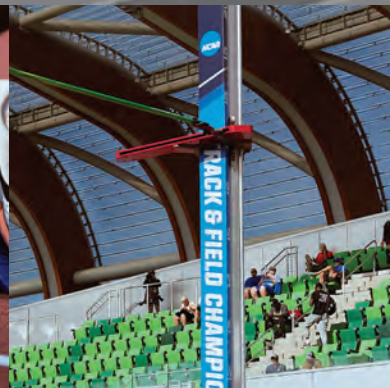

Since 1918, Gill Athletics® has empowered coaches with innovative equipment, helping coaches develop athletes and elevate sports across the globe.



GILLATHLETICS.com

GILL
ATHLETICS

FEATURING

PORTER[®]

**OWN
— THE —
COURT**

For over 150 years, Porter Athletic equipment has been trusted for smooth installation and set-up, outstanding service and support, and unsurpassed quality and durability.

BIG SHOT[®]



BIG SHOT[®] PRO SYSTEM

Features a rugged 6" upright post anchored into the ground utilizing an anchor bolt system. The 72" x 42" clear-view backboard features ½" glass and comes standard with edge padding. Official white perimeter and target area markings are silk screened on the backside to prevent wear. The extension arms offer 4' of clearance for player safety and allow the backboard to be set at any playing height from 5.5' to 10'. System is assembled using premium stainless steel hardware. Includes the Powr-Flex Competition goal, a moveable rim that protects players and equipment during slam-dunks with a concealed shock absorber.

INCLUDED: 72" x 42" Glass Backboard, Goal, Nylon Net, Post & Backboard Pads, & Mounting Hardware.

9572	Pro Package	\$3205
95758	Replacement 6" Pole Pad	\$558



BIG SHOT[®] COLLEGIATE SYSTEM

Features a 5" upright post anchored into the ground utilizing an anchor bolt system. The 60" x 36" glass backboard includes official white perimeter and target area markings silk screened on the backside to prevent wear. The system features 2.5' extension arms and can be set at any playing height from 7.5' to 10'. System is assembled using zinc plated hardware. Includes the flex goal, a moveable rim that protects players and equipment during slam-dunks with a concealed shock absorber.

INCLUDED: 60" x 36" Glass Backboard, Goal, Nylon Net, Post & Backboard Pads, & Mounting Hardware.

9571	Collegiate Package	\$2210
95708	Replacement 5" Pole Pad	\$489

BASKETBALL

HEAVY-DUTY SYSTEM

 **UNCONDITIONAL** LIFETIME WARRANTY

Heavy-duty support structure provides tremendous strength and is designed to withstand the most rugged playing conditions. Backstop provides a 5' extension into the playing court for maximum safety. Available as a single post or a back-to-back system when a multiple court layout is desired. Unconditional Lifetime Warranty is provided on the most rugged outdoor goal available. Great system for regulation outdoor competitions.

Official size 72" x 42" perforated backboard is 11 gauge steel with a massive rear support framework. Backboard is screened with official perimeter and target area markings. Backboard, goal and pole have an extremely durable powder coated finish.

195580	Standard System	\$5064
195582	Back-to-Back System	\$8151
95758	Pole Pad	\$558
00324672	Backboard Pad	\$260



ULTIMATE OUTDOOR SYSTEM

 **10** YEAR LIMITED WARRANTY

Turn any outdoor court into an official arena! Includes 6' vertical pole, 72" x 42" Center-Strut glass backboard, 240180 Torq-Flex Competition, and anti-whip net.

Pole pad and backboard pad not included, but recommended for player safety.

16675CXX \$3845



Ultimate Outdoor Powder Coat Colors

See color chart on page 51 to replace the XX in the item numbers.







GOOSENECK SYSTEMS







 **10** YEAR LIMITED WARRANTY

USE THE MATRIX TO CHOOSE YOUR EXTENSION DISTANCE, POLE DIAMETER, BACKBOARD, AND GOAL

4' Extension 4½" Diameter Pole		00235000 Super Goal	00202H00 Double Rim	00251H00 Heavy-Duty	236H00 Powr-Flex Competition
267 Fan Fiberglass		\$1,102 17412	\$1,131 17413	\$1,211 17414	\$1,330 17415
234A Fan Aluminum		\$1,287 17432	\$1,306 17433	\$1,368 17434	\$1,368 17435



Discover Our
Most Popular
Combinations

5' Extension 4½" Diameter Pole					
267 Fan Fiberglass		\$1,444 17512	\$1,473 17513	\$1,563 17514	\$1,667 17515
234A Fan Aluminum		\$1,482 17532	\$1,520 17533	\$1,606 17534	\$1,720 17535
216 72" x 42" Fiberglass		\$1,734 17582	\$1,762 17583	\$1,843 17584	\$1,962 17585

Super Duty System

Provides the utmost in safety and strength during even the toughest play. California and Florida specifications require extended pole length for a 2' deeper footing.

00251H00
Heavy-Duty

236H00
Powr-Flex
Competition

6' Extension 5 ⁹ / ₁₆ " Diameter Pole							
267 Fan Fiberglass		\$2,693 17612	\$2,769 17613	\$2,817 17614	\$2,945 17615		
234A Fan Aluminum		\$2,746 17632	\$2,765 17633	\$2,855 17634	\$2,969 17635	\$3,919 176FLSD340	\$3,952 176FLSD350
207 72" x 42" Steel		\$3,078 17652	\$3,097 17653	\$3,197 17654	\$3,311 17655	\$4,584 176FLSD540	\$4,631 176FLSD550
205A 72" x 42" Glass		\$2,988 17662	\$3,002 17663	\$3,092 17664	\$3,206 17665	\$4,085 176FLSD640	\$4,128 176FLSD650
216 72" x 42" Fiberglass		\$3,007 17682	\$3,045 17683	\$3,130 17684	\$3,235 17685		



VERTICAL POST SYSTEMS

 **10** YEAR LIMITED WARRANTY

Super Duty System

Provides the utmost in safety and strength during even the toughest play. California and Florida specifications require extended pole length for a 2' deeper footing.

USE THE MATRIX TO CHOOSE YOUR EXTENSION DISTANCE, POLE DIAMETER, BACKBOARD, AND GOAL











4' Extension 4½" Diameter Pole		00235000 Super Goal 	00202H00 Double Rim 	00251H00 Heavy-Duty 	236H00 Powr-Flex Competition 	00251H00 Heavy-Duty 	236H00 Power-Flex Competition 
267 Fan Fiberglass		\$2,166 16412	\$2,261 16413	\$2,347 16414	\$2,404 16415		
234A Fan Aluminum		\$2,494 16432	\$2,579 16433	\$2,660 16434	\$2,731 16435	\$3,159 164FLSD340	\$3,458 164FLSD350
216 72" x 42" Fiberglass		\$2,603 16482	\$2,579 16483	\$2,660 16484	\$2,731 16485		

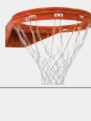

Also Available in Back-To-Back Configurations.
Call For Pricing & Details.

Super Duty System

Provides the utmost in safety and strength during even the toughest play. California and Florida specifications require extended pole length for a 2' deeper footing.

6' Extension 5 ⁹ / ₁₆ " Diameter Pole							
267 Fan Fiberglass		\$2,228 16612	\$2,294 16613	\$2,356 16614	\$2,508 16615		
234A Fan Aluminum		\$2,594 16632	\$2,660 16633	\$2,731 16634	\$2,784 16635		
207 72" x 42" Steel		\$3,468 16652	\$3,482 16653	\$3,534 16654	\$3,482 16655	\$4,608 166FLSD540	\$4,660 166FLSD550
205A 72" x 42" Glass		\$2,722 16662	\$2,769 16663	\$2,841 16664	\$2,888 16665	\$4,232 166FLSD640	\$4,289 166FLSD650
216 72" x 42" Fiberglass		\$2,632 16682	\$2,693 16683	\$2,760 16684	\$2,812 16685		

VOLLEYBALL

POWR-SAND™ OUTDOOR STANDARD

 **10** YEAR LIMITED WARRANTY

Powr-Sand, Porter's aluminum telescoping standard, was created for top level competition with thoughtful features that allow users to have equipment remain outdoors year round or remove when not in use. A pin stop telescoping standard with powdered coated handle is easily adjustable across all competitive volleyball heights. Pair the Powr-Sand standards with our high visibility Powr-Sand outdoor volleyball net, protective padding, boundary marker antennas, court marking kit and optional sand judge's stand for all the equipment needed for training and competition.

- Constructed Of High Strength, Lightweight Aluminum
- Two Reinforcing Ribs Are Centered Throughout The Entire Length Of The Post For Added System Strength
- Sealed Lower Upright Prevents Water/Sand Build-Up
- Features Heavy Duty Winch With Cover
- Pin-Lock Net Height Adjustment
- Functional Multi-Use System Provides Height Adjustment Settings For Men's, Women's And Junior USAV Competitions



STANDARD PACKAGE - 3 1/2"

30911XX

\$4285

Package Includes:

- 3091 Powr-Sand Standards (pr)
- 8390XX Official Upright Protective Pads (pr)
- 2256 Outdoor Competition Net
- 2297 Powr-Select Net Antennas (pr)
- NETCHAIN Fair Height Net Chain

INTERNATIONAL PACKAGE - 3 1/2"

30910XX

\$5680

Package Includes:

- 3091 Powr-Sand Standards (pr)
- 8390XX Official Upright Protective Pads (pr)
- 2256 Outdoor Competition Net
- 2297 Powr-Select Net Antennas (pr)
- NETCHAIN Fair Height Net Chain
- 3070 Powr-Sand Judge's Stand
- 6693XX Powr-Sand Judge's Stand Padding
- 451 Sand Rake

POWR-SAND STANDARDS & PADS

3091	Powr-Sand Standards	\$2965/pr
3060XX	Powr-Sand Pads	\$911/pr

GROUND SLEEVES

3080	Sand Ground Sleeves	\$614/ea
------	---------------------	----------

JUDGE'S STAND & STAND PADS

3070	Judge's Stand	\$829
6693XX	Judge's Stand Padding	\$517

GRAPHIC PADS

Call for Details

PROFESSIONAL OUTDOOR COURT LINE KIT

Durable 2" nylon volleyball line system for quickly and efficiently marking outdoor volleyball courts. Adjustable to USAV regulation or short court. Includes ground stakes and plastic reel. Available in blue or black.



TA380	Blue	\$130
-------	------	-------

Vinyl



Use the two-digit number of your color selection to replace XX in the item number.



GILL
ATHLETICS

FEATURING

porter[®]

ULTIMATE OUTDOOR VOLLEYBALL STANDARDS

Height adjustable posts are constructed of high-tensile strength, lightweight aluminum for durability and easy set-up. Uprights are 4" square with a built-in channel running the length of the post which allows the collar to easily slide up and down the post, providing infinite height settings. Finished in a weather resistant clear anodized finish. Net not included.

591 \$1665/pr

SOLD SEPARATELY

2256 27'10" x 3'3" Net \$258/ea

00444000 Ground Sleeve for Dirt \$313/ea

5930XX Protective Pads \$584/pr

Sand Unit:

592 Sand Conversion Kit \$272/pr

00444040 Ground Sleeve for Sand \$257/ea

**OWN
— THE —
COURT**

For over 150 years, Porter Athletic equipment has been trusted for smooth installation and set-up, outstanding service and support, and unsurpassed quality and durability.



601 Mercury Drive
Champaign, IL 61822
USA



**QUALITY.
COMMITMENT.
INNOVATION.**



2024 SPORTS FACILITIES CATALOG

GILLATHLETICS.COM
601 MERCURY DRIVE | CHAMPAIGN, IL 61822

800.637.3090
SALES@GILLATHLETICS.COM