

# ALL SPORT

ATHLETIC  
EQUIPMENT

DESIGNED TO PERFORM.  
MANUFACTURED TO LAST.



# EQUIP THE USA

Manufactured in Waterford, CT

## EQUIP AMERICA...

Jaypro Sports is working to equip America one facility at a time! With over 65 years of experience, Jaypro Sports has developed the most robust and reliable equipment for facilities of all shapes and sizes. Our complete line of indoor gymnasium and outdoor field equipment is designed for all levels of play, from Pro to Recreational. Look to Jaypro Sports to EQUIP your field or court today.

## OUR OBJECTIVE...

We are committed to providing the highest quality athletic equipment to help customers achieve the ultimate success. Innovative designs, sound engineering and quality building techniques provide the ability to ensure your facility will be the best it can be.

## OUR GOAL...

We will provide athletic facility equipment solutions that are...

**DESIGNED TO PERFORM.  
MANUFACTURED TO LAST.**







## Volleyball

page 2-23

## Soccer

page 24-55

## Football

page 56-66

## Field Hockey/Lacrosse

page 67-73

## Baseball/Softball

page 74-105

## Field Marking

page 106-107

## Basketball/Gymnasium

page 108-143

## Facilities

page 144-159

## Scoreboards

page 160-161

## Physical Education

page 162-167

## Ball Storage

page 168-171

## Field Netting

page 172-175

## Track & Field

page 176-181

## Tennis

page 182-189

## Benches/Bleachers

page 190-201

Recessed impact resistant pulley wheels

### System Includes:



Uprights with Winch



Flex Net™



Upright Padding



Antenna



3" models have an adapter on the bottom of the pole to insert into a 3" floor sleeve

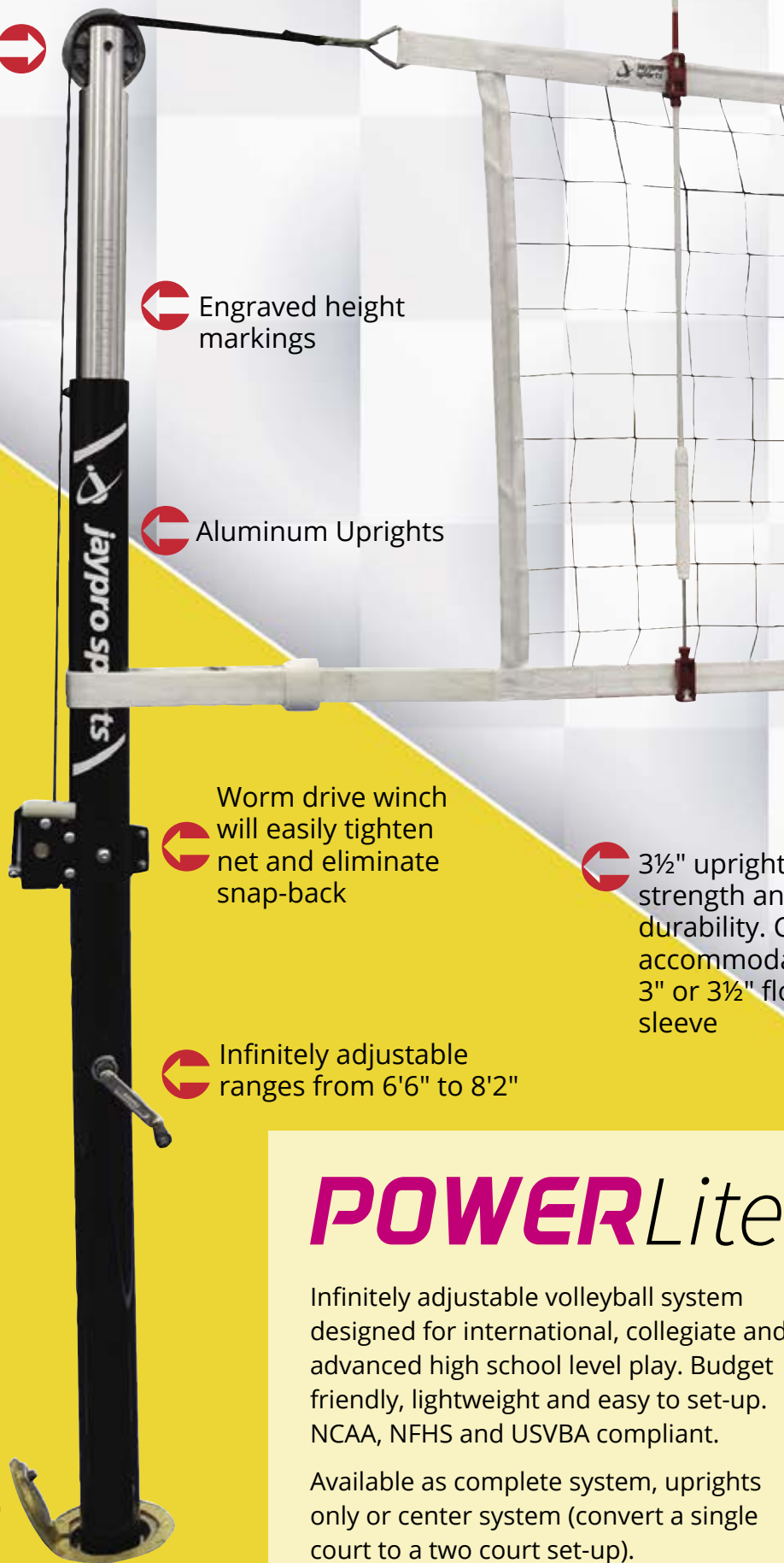

Engraved height markings

Aluminum Uprights

Worm drive winch will easily tighten net and eliminate snap-back

Infinitely adjustable ranges from 6'6" to 8'2"

3½" upright for strength and durability. Can accommodate a 3" or 3½" floor sleeve



Lockable Floor Sleeves and Covers available

See (page 20)

## POWERLite™

Infinitely adjustable volleyball system designed for international, collegiate and advanced high school level play. Budget friendly, lightweight and easy to set-up. NCAA, NFHS and USVBA compliant.

Available as complete system, uprights only or center system (convert a single court to a two court set-up).

**10 Year Limited Warranty** on Uprights



# POWERLITE PACKAGES

Standard Package Includes:

Powerlite™ Uprights	PVB-70U/PVB-65U
Flex Net™	PVBN-6
Upright Padding	PVB-60P
Antenna	VBA-80
Folding Referee Stand	VRS-6000
Referee Stand Padding	VRS-60P
Hammock Drill Cart	HSVBC24
Cable/Buckle Covers	VCC-12

<b>For 3½" Floor Sleeve</b>	PVB-7PKG (PKG)
<b>For 3" Floor Sleeve</b>	PVB-6PKG (PKG)

Deluxe Package Includes:

**All items from the Standard Package PLUS**

Standard Equipment Carrier	EC-500
Custom Net Tape	CVNT-1
Multi-Color Graphics	JSG-VPP

<b>For 3½" Floor Sleeve</b>	PVB-7PKGDX (PKG)
<b>For 3" Floor Sleeve</b>	PVB-6PKGDX (PKG)



**VINYL PAD COLORS:** Specify pad color when ordering



Standard Package Includes:

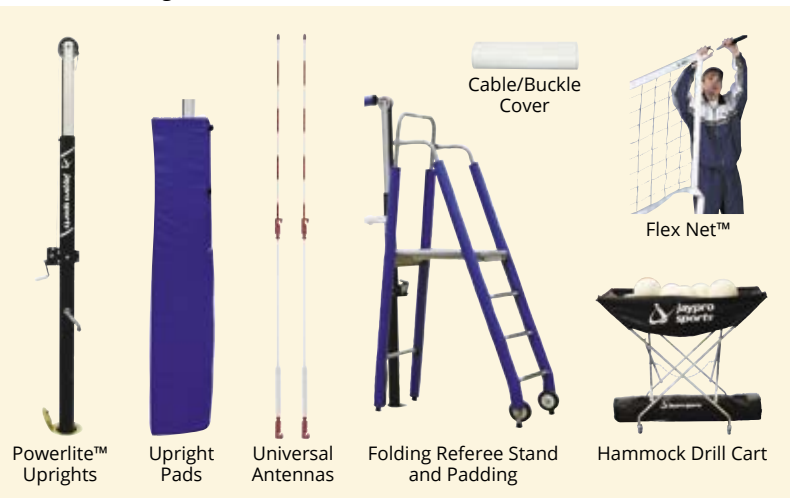

Deluxe Package includes below & Standard Package items:



## POWERLITE SYSTEMS



<b>For 3½" Floor Sleeve</b>	
<b>3½" Complete System</b>	PVB-7000 (SYS)
<b>3½" Uprights Only</b>	PVB-70U (PAIR)
<b>3½" Center System</b>	PVBC-700 (PKG)

<b>For 3" Floor Sleeve</b>	
<b>3" Complete System</b>	PVB-6500 (SYS)
<b>3" Uprights Only</b>	PVB-65U (PAIR)
<b>3" Center System</b>	PVBC-650 (PKG)

For more information, scan or go to:  
[www.jaypro.com/Volleyball](http://www.jaypro.com/Volleyball)





← Recessed impact resistant pulley wheels

Engraved height markings →

Pin-stop height adjustment range from intramurals to men's height, 6'6" to 8'2" →

→ 3½" upright for strength and durability. Can accommodate a 3" or 3½" floor sleeve

→ Worm drive winch will easily tighten net and eliminate snap-back

← Aluminum Uprights

← Lockable Floor Sleeves and Covers available

See (page 20)

### System Includes:



Uprights with Winch



Flex Net™



Upright Padding



Antenna



3" & 2" models have an adapter on the bottom of the pole to insert into a 3" floor sleeve

# FEATHERLite™

Most affordable high performance, all aluminum uprights with a 16 pin-stop height adjustment range makes this adjustable system perfect for collegiate and high school level play. This lightweight design makes it easy to move around the gym and is very easy to set-up. NCAA, NFHS and USVBA compliant.

Available as complete system, uprights only or center system (convert a single court to a two court set-up).

**10 Year Limited Warranty** on Uprights



# FEATHERLITE PACKAGES

Standard Package Includes:

Featherlite™ Uprights	PVB-51U/PVB-45U
Flex Net™	PVBN-6
Upright Padding	PVB-60P
Antenna	VBA-80
Folding Referee Stand	VRS-6000
Referee Stand Padding	VRS-60P
Hammock Drill Cart	HSVBC24
Cable/Buckle Covers	VCC-12



<b>For 3½" Floor Sleeve</b>	PVB-5PKG (PKG)
<b>For 3" Floor Sleeve</b>	PVB-4PKG (PKG)

Deluxe Package Includes:

**All items from the Standard Package PLUS**

Standard Equipment Carrier	EC-500
Custom Net Tape	CVNT-1
Multi-Color Graphics	JSG-VPP
<b>For 3½" Floor Sleeve</b>	PVB-5PKGDX (PKG)
<b>For 3" Floor Sleeve</b>	PVB-4PKGDX (PKG)

VINYL PAD COLORS: Specify pad color when ordering



Standard Package Includes:



Deluxe Package includes below & Standard Package items:



## FEATHERLITE SYSTEMS



<b>For 3½" Floor Sleeve</b>	
<b>3½" Complete System</b>	PVB-5000 (SYS)
<b>3½" Uprights Only</b>	PVB-51U (PAIR)
<b>3½" Center System</b>	PVBC-500 (PKG)

<b>For 3" Floor Sleeve</b>	
<b>3" Complete System</b>	PVB-4500 (SYS)
<b>3" Uprights Only</b>	PVB-45U (PAIR)
<b>3" Center System</b>	PVBC-450 (PKG)

<b>For 2" Floor Sleeve</b>	
<b>Canadian System</b>	
<b>2" Complete System</b>	PVB-5500 (SYS)
<b>2" Uprights Only</b>	PVB-55U (PAIR)

## T-BASE COMPETITION NET SYSTEMS

Details on (page 10)

<b>3½" Complete System</b>	PVB-2500 (SYS)
<b>3½" Uprights &amp; Bases</b>	PVB-250UB (PAIR)
<b>3½" Center System</b>	PVBC-250 (PKG)

For more information, scan or go to:  
[www.jaypro.com/Volleyball](http://www.jaypro.com/Volleyball)



# CARBON ULTRALITE™



Pin-stop height adjustment range from intramurals to men's height, 6'6" to 8'2"

3½" upright for strength and durability. Can accommodate a 3" or 3½" floor sleeve

Adjustable feet



## System Includes:



Uprights with Winch



Upright Padding

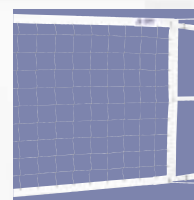

Premium Net



Antenna



Significantly lightweight volleyball systems with the rigidity of steel. Fabricated from state-of-the-art carbon composite material. The ease of lifting these 19 lb. uprights will help with the set-up ease of the carbon system. Our Ultralite system telescopes from intramurals to men's height. NCAA, NFHS and USVBA compliant.

Available as complete system, uprights only or center system (convert a single court to a two court set-up).

**10 Year Limited Warranty** on Uprights



# CARBON PACKAGES

Deluxe Package Includes:

Carbon Ultralite™ Uprights	PVB-90U/PVB-95U
Upright Padding	PVB-60P
Premium Net	PVBN-5
Antenna	VBA-80
Folding Referee Stand	VRS-6000
Referee Stand Padding	VRS-60P
Custom Post Pad Graphics	JSG-VPP
Custom Net Tape	CVNT-1
Volleyball Equipment Carrier	EC-500
Hammock Drill Cart	HSVBC24
Cable/Buckle Covers	VCC-12



## Ultralite Deluxe Package - For 3½" Floor Sleeve

PVB-9PKGDX (PKG)

## Ultralite Deluxe Package - For 3" Floor Sleeve

PVB-95PKGDX (PKG)

VINYL PAD COLORS: Specify pad color when ordering



Package Includes:



## CARBON ULTRALITE



### For 3½" Floor Sleeve

<b>3½" Complete System</b>	PVB-9000 (SYS)
<b>3½" Uprights Only</b>	PVB-90U (PAIR)
<b>3½" Center System</b>	PVBC-900 (PKG)

### For 3" Floor Sleeve

<b>3" Complete System</b>	PVB-9500 (SYS)
<b>3" Uprights Only</b>	PVB-95U (PAIR)
<b>3" Center System</b>	PVBC-950 (PKG)

For more information, scan or go to:  
[www.jaypro.com/Volleyball](http://www.jaypro.com/Volleyball)



# HYBRID STEEL SYSTEMS

Designed for all levels of play. Steel bottom for strength and aluminum top for lightness!

- Uprights with engraved height markers
- Pin-stop height adjustment range from intramurals to men's height, 6'6" to 8'2"
- Recessed pulley wheels and worm drive winch
- Available in 3" (red) and 3½" (black) models
- Complete system, uprights only, and center system (convert a single court to a two court set-up)
- Flex Net™ (PVCN-6), antennas (VBA-80), and upright padding (PVB-60P) included with complete system
- 10 Year Limited Warranty: Uprights

## HYBRID STEEL NET SYSTEMS



### For 3½" Floor Sleeve

<b>3½" Complete System</b>	PVB-1500 (SYS)
<b>3½" Uprights Only</b>	PVB-150U (PAIR)
<b>3½" Center System</b>	PVBC-150 (PKG)

### For 3" Floor Sleeve

<b>3" Complete System</b>	PVB-3000 (SYS)
<b>3" Uprights Only</b>	PVB-30U (PAIR)
<b>3" Center System</b>	PVBC-300 (PKG)

VINYL PAD COLORS: *Specify pad color when ordering*



## System Includes:



Uprights with Winch



Flex Net™



Upright Padding



Antenna



PVB-1500

PVB-3000



# MULTI-PURPOSE SYSTEMS

Lightweight adjustable net system for high school, intramural, and recreational play.

- Anodized aluminum uprights with infinite height adjustment sliding collars
- Available in 3½", 3" and 2" (Canadian) models
- Adjustable for badminton (BND-1 net), tennis (TPV-13 net) and volleyball (PVBN-3 net) sold separately
- Net (PVBN-3), antennas (VBA-80), worm drive winch, and upright padding (PVB-60P) included with complete system
- Complete system, uprights only, and center system (convert a single court to a two court set-up)
- 10 Year Limited Warranty: Uprights

## MULTI-PURPOSE NET SYSTEMS



### For 3½" Floor Sleeve

<b>3½" Complete System</b>	PVB-1350 (SYS)
<b>3½" Uprights Only</b>	PVB-13U (PAIR)
<b>3½" Center System</b>	PVBC-135 (PKG)

### For 3" Floor Sleeve

<b>3" Complete System</b>	PVB-1300 (SYS)
<b>3" Uprights Only</b>	PVB-1300U (PAIR)
<b>3" Center System</b>	PVBC-130 (PKG)

### For 2" Floor Sleeve

<b>Canadian System</b>	
<b>2" Complete System</b>	PVB-1250 (SYS)
<b>2" Uprights Only</b>	PVB-12U (PAIR)

VINYL PAD COLORS: *Specify pad color when ordering*



### System Includes:



Uprights with Winch



Antenna



Competition Net



3" & 2" models have an adapter on the bottom of the pole to insert into a 3" floor sleeve



Upright Padding

PVB-1350

For more information, scan or go to:  
[www.Jaypro.com/Volleyball](http://www.Jaypro.com/Volleyball)





# T-BASE VOLLEYBALL SYSTEMS

Adjustable systems designed for collegiate and high school level play. For use where floor sleeves are impractical. Top level performance without cables or wires.

- 3½" aluminum uprights with bases
- Pin-stop height adjustment models
- Adjustment range from intramurals to men's height, 6'6" to 8'2"
- Hand knobs secure steel T-base to in-floor anchors (sold separately)
- Flex Net™ (PVBN-6), upright/base padding (PVB-60P & PVB-25P), antennas (VBA-80), and worm drive winch included
- Complete system, uprights only, and center system (convert a single court to a two court set-up)
- 10 Year Limited Warranty: Uprights

## T-BASE COMPETITION NET SYSTEMS



<b>Featherlite™ T-Base Complete System</b>	PVB-2500 (SYS)
<b>Featherlite™ T-Base Uprights &amp; Bases</b>	PVB-250UB (PAIR)
<b>Featherlite™ T-Base Center System</b>	PVBC-250 (PKG)



## T-BASE VOLLEYBALL BASE PAD



Standard base pad designed for T-Base Competition Net System (PVB-2500).

- Order along with the official upright padding (PVB-60P) for a complete pad covering for your 2nd floor system
- 1 Year Limited Warranty

**Base Pad** PVB-25P (PAIR)

**VINYL PAD COLORS:** *Specify pad color when ordering*







Save on external storage and set-up time with a Ceiling Suspended Volleyball System by Jaypro Sports. This system stores fully assembled and close to the ceiling, is raised and lowered using a 1 HP winch, and is offered with or without an attached referee stand. Additionally, the net height is infinitely adjustable to meet both men’s and women’s regulation heights.

## CEILING SUSPENDED VOLLEYBALL SYSTEM



Adjustable ceiling suspended system conveniently raises and lowers with a turn-key solution for quick set-up.

- Engraved height markers (0-20" range)
- Net height adjustment handles on uprights
- Exposed posts and frames are fully padded
- Collegiate net and antennas included
- Call Customer Service for Warranty details

Contact Jaypro Sports and let our Engineers custom design a ceiling suspended volleyball system to fit your facility.

Call for freight quote.

### System with Referee Stand

PVBOH-880R (EACH)

Electric winch designed specifically for use on overhead volleyball system positioning applications.

(See page 150 for product details)

SBBW-4



# BEACH SYSTEMS

Adjustable beach system with inverted telescoping design and carbon reinforced caps to prevent sand and water infiltration.

- Lightweight aluminum design with white powder coat finish
- Adjustable height between 5'6" and 7'11½"
- 3½" bottom poles compatible with any 3½" ID sleeves (OBV-100AK recommended and sold separately)
- Mercury™ net (professional or competitive size), antenna, and upright padding included
- 10 Year Limited Warranty: Uprights

## MERCURY™ BEACH VOLLEYBALL SYSTEM



### Mercury™ Professional Beach System

OBV100-OFF (SYS)

### Mercury™ Competitive Beach System

OBV100-REC (SYS)

### Mercury™ Uprights Only

OBV100U (PAIR)

### Ground Inserts

OBV-100AK (PAIR)

### Adjustable Court Line *(see page 13)*

AVCL-2 (EACH)

**VINYL PAD COLORS:** *Specify pad color when ordering*



## System Includes:



Uprights with Winch

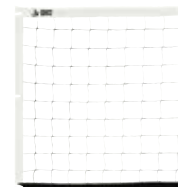

Mercury™ Net



Upright Padding



Antenna



Optional Ground Insert with flag locator



## MERCURY™ BEACH VOLLEYBALL NET

- 3" vinyl border and headband with 4" #36 black netting
- ¼" top Plateena cord with swaged loop on one end
- ¼" double braided polyester bottom rope
- Dowels and polyester straps with buckles included
- Custom headband (CVNT-1) and side net tapes (CVNT-2) sold separately
- 1 Year Limited Warranty

**Collegiate NCAA Net - 28'L x 39"H**

OBVN-1 (EACH)

**Competitive Net - 32'L x 39"H**

OBVN-2 (EACH)





### COASTAL COMPETITION VOLLEYBALL SYSTEM



Heavy-duty system designed to withstand coastal winds and weather. Adjustable winch for play at any height!

- 4" square heavy-walled aluminum uprights with additional inside lateral support
- Ground sleeves, installation tool, winch, and weather resistant net (OCC-500N) included
- 3 Year Limited Warranty: Uprights

<b>System</b>	OCC-500 (SYS)
<b>Replacement Net</b>	OCC-500N (EACH)

### ADJUSTABLE VOLLEYBALL COURT LINE

- 2" wide blue webbed boundary line
- Adjusts from 30' x 60' to FIVB regulation (8m x 16m)
- 8" corner stakes with bungee cord and plastic reel included
- 1 Year Limited Warranty

AVCL-2 (EACH)



### OUTDOOR COMPETITION VOLLEYBALL UPRIGHTS



Durable system designed for outdoor competition. Fixed net heights for men's and women's play!

- 3½" galvanized steel uprights with silver powder coat finish
- Quickly attach net with snap buckles
- Available in system & center system models
- 36" ground sleeves, cover caps, and rust-resistant ratchet included
- Net (PVBN-3) recommended and sold separately.
- 3 Year Limited Warranty: Uprights

<b>System</b>	OCV-900 (SYS)
<b>Center System</b>	OCV-900C (EACH)



### RECREATIONAL OUTDOOR VOLLEYBALL UPRIGHTS



Ideal for volleyball, badminton, or tennis.

- 2¾" galvanized steel uprights
- PVC ground sleeves, top caps, and rust-resistant ratchet winch included
- Net (VBN-32) sold separately for (OS-350) and included for (OS-350-GS)
- 3 Year Limited Warranty: Uprights

*Ground sleeves are designed to be set even with playing surface. Contact Jaypro for installation requirements.*

<b>Uprights</b>	OS-350 (SYS)
<b>Package</b>	OS-350-GS (PKG)
<b>Ground Sleeves</b>	OS-350G (PAIR)

# UPRIGHT PADDING

Protect players from injury during play.

- Meets competitive play specifications and fits all volleyball system uprights
- 6'H x 2" thick foam wrapped in 14 oz. vinyl (Choose from 14 colors)
- Hook-and-loop closure flaps
- Custom graphics sold separately
- 1 Year Limited Warranty

Specify pad color when ordering.

## OFFICIAL UPRIGHT PADS

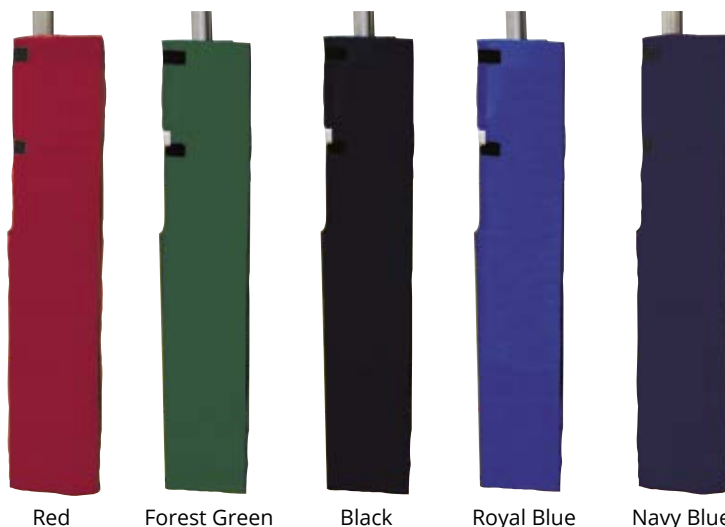

Red Forest Green Black Royal Blue Navy Blue

PVB-60P (PAIR)



Gray Maroon Purple Kelly Green Yellow Pink Tan Orange Light Blue

## CUSTOM GRAPHICS FOR UPRIGHT PADS



Bring us your artwork and we will design custom pads to keep a look of professionalism and individuality, PLUS protect your players!

Custom graphics are on both sides of each pad. Contact customer service for artwork requirements and pricing.

Multi-Color

PVB-60PGRX (PAD)







# NET KEEPERS

1½" thick-walled steel design with powder coat finish and non-marking swivel wheels. Headband is wound clean and tangle free.

- 3 Year Limited Warranty



**SINGLE NET KEEPER**

VNK11 (EACH)

**DOUBLE NET KEEPER**

VNK22 (EACH)

**TRIPLE NET KEEPER**

VNK33 (EACH)

**NET KEEPER STORAGE BAG**

Storage bag

VNKBAG (EACH)



# FLEX NET™



## VOLLEYBALL NETS

Heavy-duty nylon banded net eliminates use of cumbersome cables. Designed for international, collegiate, and high school competition play!

- For uprights set between 35' and 37' (alternate sizes available)
- Headband attaches directly to winch leader strap for superb net tension
- Adjustable straps attach to existing bottom band for additional length
- 1 Year Limited Warranty

*Due to varying court sizes, the net body may not match all court widths. Custom sizes available, call for pricing.*

### FLEX NET™



32'L x 39"H

PVBN-6 (EACH)

28'L x 39"H

PVBN-628 (EACH)

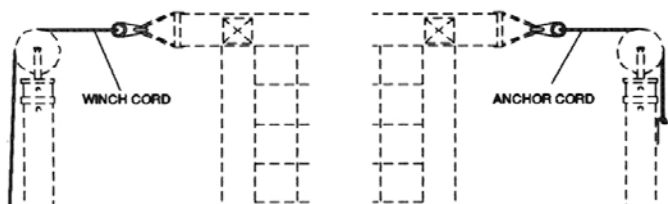

### FLEX NET™ WITH ADAPTER CORD

- Includes PVBN-6 Flex Net™, plus two adapter cords that connect to existing winch and anchor side upright
- ¼" dia. anchor cord and quicklink included
- Cords are compatible with cable style pulley sheaves
- 1 Year Limited Warranty

*Compatible with most manufacturer's systems such as Porter, Senoh, Bison, MacGregor, Stackhouse, Schelde, or other similar volleyball systems. Anchor cord should be cut to length in the field to adapt to the specific volleyball system.*

PVBN-6AK (EACH)

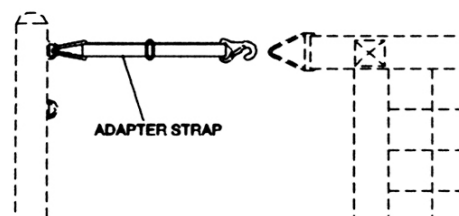

### FLEX NET™ WITH ADAPTER STRAP

- Includes PVBN-6 Flex Net™, plus one 2" wide adapter strap to connect net to the anchor side upright
- 1 Year Limited Warranty

*Compatible with Schelde or other similar volleyball systems.*

PVBN-6J (EACH)



### CUSTOM VOLLEYBALL NET TAPE



Customize volleyball nets with multi-color graphics. Fits most net sizes. Contact customer service for artwork requirements. Extended lead time may apply.

- 1 Year Limited Warranty

*Contact customer service for artwork requirements.*

**Top Net Tape**  
**Side Net Tape**

CVNT-1 (EACH)  
CVNT-2 (PAIR)



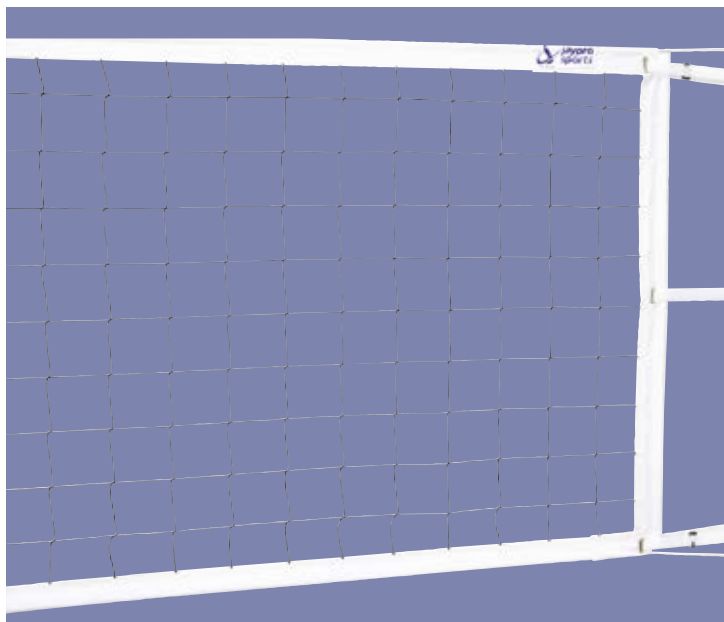

### PREMIERE COMPETITION NET



Used on multiple systems including Collegiate and High School.

- 3mm knotless poly net
- Plateena top cord: 47' long
- 32'L x 39"H
- 1 Year Limited Warranty

PVBN-5 (EACH)



### COMPETITION NET



High School and Recreational use.

- #21 nylon net
- Coated steel cable
- 32'L x 39"H
- 1 Year Limited Warranty

PVBN-3 (EACH)



### VOLLEYBALL NET

Recreational use.

- 2.5mm poly net
- Coated steel cable
- 32'L x 36"H
- 1 Year Limited Warranty

VBD-3 (EACH)



### VOLLEYBALL NET

Recreational use.

- Nylon net
- Rope cable
- 32'L x 36"H
- 1 Year Limited Warranty

VBN-32 (EACH)

# REFEREE STANDS

## "MEGA REF" FOLDING REFEREE STAND

Fold for compact storage and easy transport!

- 1 $\frac{5}{8}$ " heavy-walled steel frame with welded supports
- Vinyl padded platform and no-slip foot treads
- 4 non-marking wheels and rubber leg tips
- Optional padding (VRS-60P) sold separately
- Folds Down - 30"W x 84"H x 10"D
- 3 Year Limited Warranty

300 lbs. maximum user weight.

**Stand** VRS-8000 (EACH)

**Stand Padding** VRS-60P (EACH)



Shown with VRS-60P



## FOLDING REFEREE STAND



Durable referee stand folds for compact storage and easy transport.

- 1 $\frac{5}{16}$ " strong steel design
- Vinyl padded platform (48" above floor)
- 2 non-marking wheels and rubber leg tips
- Optional padding (VRS-60P) sold separately
- Folds Down - 30"W x 84"H x 10"D
- 3 Year Limited Warranty

250 lbs. maximum user weight.

**Stand** VRS-6000 (EACH)

**Stand Padding** VRS-60P (EACH)



Folds down for compact storage



Shown with VRS-60P



## ADJUSTABLE REFEREE STAND

Durable two leg design referee stand clamps onto most steel pole systems. Adjustable feet for tweaking height!

- 1 $\frac{5}{16}$ " strong steel design with vinyl padded platform
- 2 non-marking wheels and rubber leg tips
- Optional padding (VRS-30P) sold separately
- 3 Year Limited Warranty

*Does not fit Multi-Purpose Net System (PVB-1350) or Outdoor Competition Volleyball System (OCV-900).*

225 lbs. maximum user weight.

**Stand** VRS-3000 (EACH)

**Stand Padding** VRS-30P (EACH)



Stand clamps to volleyball pole



Shown with optional padding



Shown with optional side banners (CVNT-3)

## BEACH VOLLEYBALL REFEREE STAND



Durable steel referee stand with all welded frame support and no-slip foot treads. Front base plate prevents stand from sinking. Transports across sand easily!

- 1½" heavy-walled design with silver textured powder coat finish
- Padded platform (48" above sand)
- 2 heavy-duty 10" dia. x 3½"W molded wheels
- Optional padding (VRS-60P) and custom side banners (CVNT-3) sold separately
- Folds Down - 30"W x 84"H x 10"D
- 3 Year Limited Warranty

300 lbs. maximum user weight.

<b>Stand</b>	OBVRS-8 (EACH)
<b>Optional Padding</b>	VRS-60P (EACH)
<b>Custom Side Banners (Set of 2)</b>	CVNT-3 (SET)



EC-500  
Standard Model



EC-1000  
Deluxe Model

## VOLLEYBALL EQUIPMENT CARRIER

Heavy-duty welded steel carrier stores volleyballs, uprights, nets, pads, and other equipment. Protective powder coat finish!

- Non-marking swivel wheels
- Standard and deluxe models
- Deluxe model includes a vinyl storage hammock
- 3 Year Limited Warranty

**42"L x 32"W (4 poles)** EC-500 (EACH)

**48"L x 36"W (6 poles)** EC-1000 (EACH)



## WALL RACK

- Holds 3 volleyball posts in upright position
- Heavy-duty steel storage rack attaches to wall
- 3 Year Limited Warranty

VBWR-1 (EACH)



# FLOOR SLEEVES AND COVERS

Unique locking feature which is tamper resistant. Hinge feature allows easy installation.

- Lockable hinged cover
- Heavy-duty cast brass or chrome finish design
- 7½" or 8½" outside dia. cover plates
- Spring loaded latch prevents basketball dead spots
- Available in 3½", 3", and 2¾" models (10" deep)
- 3 Year Limited Warranty

## COVER PLATES & SLEEVES

<b>Brass 3½"</b>	PVB-75S (PAIR)
<b>Chrome 3½"</b>	PVB-75S-CP (PAIR)
<b>Brass 3"</b>	PVB-70S (PAIR)
<b>Chrome 3"</b>	PVB-70S-CP (PAIR)
<b>Brass 2¾"</b>	BSO-2G (PAIR)
<b>Chrome 2¾"</b>	BSO-2G-CP (PAIR)

## COVER PLATES

<b>Brass 7½"</b>	PVB-711 (EACH)
<b>Chrome 7½"</b>	PVB-75CVR-CP (EACH)
<b>Brass 8½"</b>	PVB-85CVR (EACH)

Chrome Finish



Brass Finish



Standard  
PVB-711, PVB-75CVR-CP

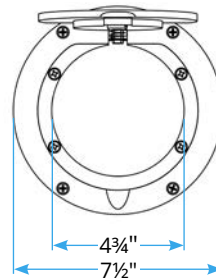

Over-sized  
PVB-85CVR

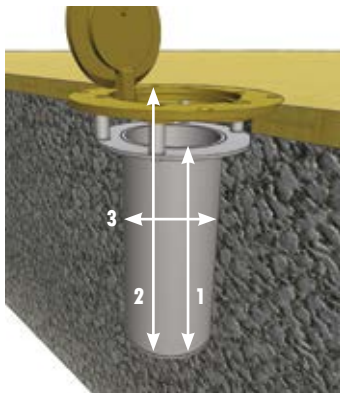
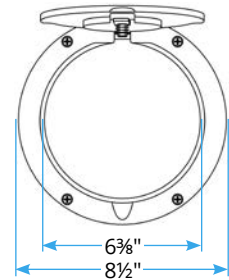

## SLEEVE INSERT MEASUREMENT

To ensure proper fit of sleeve inserts, provide the following dimensions of sleeves when ordering.

1. Depth of sleeve itself
2. Depth from bottom of sleeve to playing surface
3. Inside diameter of sleeve (do not measure cover plate)

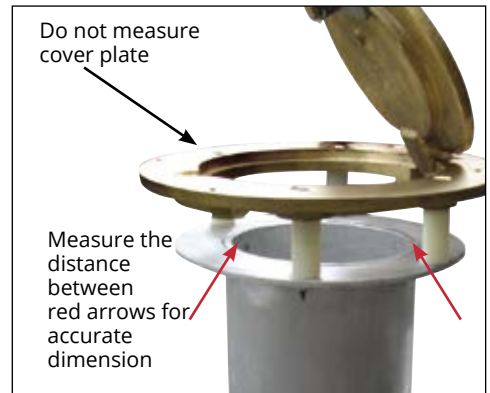

## SLEEVE INSERT/ADAPTER



- Reduces the diameter of an existing floor sleeve
- 3 Year Limited Warranty

Call customer service before ordering.  
Custom sizes are not returnable.

<b>Modifies 3" to 2¾" ID x 8"L</b>	SVL-3238 (EACH)
<b>Modifies 3½" to 3" ID x 8"L</b>	PVB-ID (EACH)
<b>Modifies 3½" to 2¾" ID x 8"L</b>	SVL-3528 (EACH)
<b>Modifies 3¾" to 3½" ID x 8"L</b>	SVL-37835 (EACH)
<b>Modifies 4" to 3½" ID x 8"L</b>	SVL-4035 (EACH)
<b>Depth Reducer</b>	PVB-DEP (EACH)

Inside Diameter (ID)

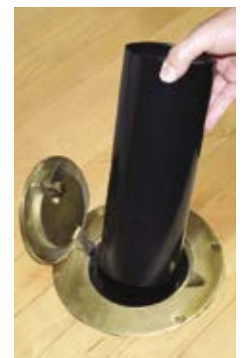



**FLOOR ANCHOR  
(1 1/4" CYLINDER)**

For systems with "T" style or round bases that anchor to floor.

- 3/4" chrome cover with 1 1/4" wide cylinder
- Billet steel body gives 9000 lb. pullout strength
- 1/2" center - 13 thread with spring loaded closure plug
- Includes removable cylinder in case stripping occurs
- 3 Year Limited Warranty

*Designed for all floor applications except floating wood floors. May be used without extension bolt on wood, tile, or synthetic surfaces applied directly over concrete slab or on a floating wood floor for light-duty performance.*

FP-89 (EACH)



**FLOOR ANCHOR  
(1 1/4" CYLINDER)**

For systems with "T" style or round bases that anchor to floor.

- 1 1/4" wide cylinder
- Billet steel body gives 9000 lb. pullout strength
- 1/2" center - 13 thread with spring loaded closure plug
- Includes removable cylinder in case stripping occurs
- 3 Year Limited Warranty

*Designed for all floor applications except floating wood floors. May be used without extension bolt on wood, tile, or synthetic surfaces applied directly over concrete slab or on a floating wood floor for light-duty performance.*

FP-90 (EACH)



**FLOATING WOOD FLOOR ANCHOR  
(1 1/4" CYLINDER)**

Brass cover plate and anchor work independently to allow for installation into floating wood floors.

- 3/4" brass cover with 1 1/4" wide cylinder
- Billet steel body gives 9000 lb. pullout strength
- 1/2" center - 13 thread with spring loaded closure plug
- Includes removable cylinder in case stripping occurs
- 3 Year Limited Warranty

FP-100 (EACH)

**SYSTEM REPLACEMENT PARTS**

**WORM DRIVE WINCH  
CARGO BUCKLE WINCH  
LEADER STRAP**

**HANDLE  
WINCH HANDLE  
PIN CHAIN ASSEMBLY**

Visit us online at [www.jaypro.com](http://www.jaypro.com) for the purchase of Volleyball system replacement parts



### HAMMOCK DRILL CART

Durable steel frame is collapsible for easy storage with a low profile. Perfect reach for the coaches who run fast paced drills.

- Holds up to 24 balls
- Nylon carry bag with shoulder strap included
- 48"L x 22"W x 40"H x 12"D
- 1 Year Limited Warranty

HSVBC24 (EACH)



### TOTEMASTER™ OPEN TOP

- Holds up to 33 volleyballs, nets, pads, and other equipment
- 4" x 3" wire mesh open top storage baskets
- 48"L x 26"W x 54"H
- 1 Year Limited Warranty

TE-PE01 (EACH)



### VOLLEYBALL POST TRANSPORTER

Post transporter provides an easy solution for moving volleyball uprights in and out of storage.

- (2) wheels with bearings with flat leveling plate
- Fits 3" and 3½" uprights
- 3 Year Limited Warranty



VBT (EACH)

### UNIVERSAL ANTENNAS

- 72" long alternating red/white stripes
- Clamps directly to top and bottom of net
- Fits 36" and 39" nets
- 1 Year Limited Warranty

VBA-80 (PAIR)



### ANTENNAS

- Slides into hook-and-loop attached sleeves
- Fits 36" and 39" nets
- 1 Year Limited Warranty

VBA-4 (PAIR)



### CABLE/BUCKLE COVER



- 12" long white vinyl covered foam
- Hook-and-loop attachment
- 1 Year Limited Warranty

VCC-12 (PAIR)

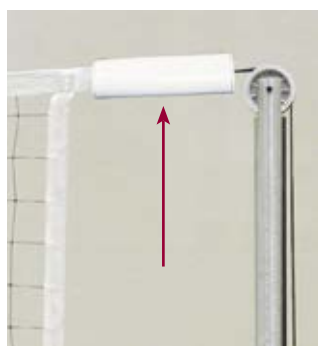

### BOUNDARY TAPE

- 2" tape with hook-and-loop closure
- Fits 36" and 39" nets
- 1 Year Limited Warranty

VA-22 (PAIR)





# ATTACK VOLLEYBALL MACHINES

Wheel propelled for increased performance. Maximize daily practice drills with repeatable reps for serve receive, sets, digs, and spikes. Sharp topspins, breaking floaters, and more!



## ATTACK VOLLEYBALL MACHINE



- For men's games
- Spike speeds up to 80+ mph
- Ball release point of 6' to 9'3"
- 5 Year Limited Warranty

VBSA-1 (EACH)



## ATTACK II VOLLEYBALL MACHINE



- For women's games
- Spike speeds up to 70 mph
- Ball release point of 5'6" to 8'6"
- 5 Year Limited Warranty

VBSA-2 (EACH)

## REPLACEMENT BAG

- 1 Year Limited Warranty

VBSA-BAG (EACH)



## SKILL ATTACK VOLLEYBALL MACHINE



- For club/youth programs
- Spike speeds up to 40 mph
- Ball release point of 5'3"
- 5 Year Limited Warranty

VBSA-3 (EACH)



# **NOVA**<sup>™</sup> World Cup<sup>™</sup> Goal

Up your game with the look and feel of a Professional team. Completely portable goal to use in situations where you cannot use ground sleeves. The back net posts have the option to powder coat your team color for a unique look. Easy Track<sup>™</sup> net attachment system is on the complete frame and bottom bases for easy installation of the net. NCAA, NFHS and FIFA compliant. Available as goal pair, or package.

**12 Year Limited Warranty** on Goal

## **Goal Features:**



4" round front frame with upright brace



Tension Cable



Corner fitting for back net posts



Net attachment around entire frame



# NOVA™ WORLD CUP GOAL PACKAGE

# NOVA™



Package Includes:

- (2) NOVA™ World Cup Goals SGP-850
- (2) Box Soccer Nets SGP-850N
- (2) Wheel Kits NSGWK
- (6) Sandbag Anchors SWB-451W

Customize the rear back posts with optional powder coat colors. Additional charges apply.

SGP-850PKG (PKG)

Features the

**EASY TRACK™**  
Flush mounted Net Attachment System

Package Includes:



NOVA™ World Cup Goal



Wheel kits



Sandbag anchors



Box nets



Flush mounted net attachment

## Additional Options:

Customize your rear back posts with school or team colors.

Contact Customer Service for details.



## NOVA™ WORLD CUP GOAL



Totally portable World Cup goal that is all-surface friendly.

- All aluminum goal, powder coated white
- 4" extruded aluminum goal face with 2" x 4" base frame
- Features Jaypro Sports flush mount Easy Track™ net attachment system with clips
- White 2 $\frac{3}{8}$ " steel back net posts (color options available for additional charge - call for details)
- Ground anchors (SAS-95), and nets (SGP-850N) included
- Stainless steel hardware included
- Optional wheel kit (NSGWK) sold separately
- 8'H x 24'W x 7'B x 8'D
- 12 Year Limited Warranty

SGP-850 (PAIR)





## NOVA™ WORLD FOLD-UP GOAL



Box style professional goal for use with permanent or semi-permanent installation.

- Aluminum goal with white powder coat finish
- Field maintenance friendly with fold-up rear frame can be temporarily pinned or permanently locked in raised position
- 4" extruded aluminum with a 2" x 4" base frame
- 2 $\frac{3}{8}$ " galvanized steel back posts
- Features Jaypro Sports flush mount Easy Track™ net attachment system with clips
- Ground sleeves for semi-permanent installation sold separately
- World competition hex net and stainless steel hardware included
- 8'H x 24'W x 6'B x 6'D
- 12 Year Limited Warranty

SGP-660 (PAIR)

**NOVA™**



Features the

**EASY TRACK™**  
Flush mounted Net Attachment System



## FIELDPRO™ SOCCER BALL STOP SYSTEM



Stop wasting time chasing missed shots or errant passes during practice and games. Ensure the safety of athletes, coaches, and spectators.

- (4) 4" heavy-walled aluminum uprights with ground sleeves
- Ground sleeve covers optional (FN-20-C)
- #36 knotted black nylon net with 3½" sq. mesh and ¼" rope border
- Pulley system to raise/lower net included
- Corrosion-resistant hardware included
- 3 Year Limited Warranty

*Custom sizes available. Standard upright color is black. Custom colors available upon request for additional charge. See (pages 172-175) for more FieldPro™ Net System options.*

**20'H x 65'W**

FNSB-65 (EACH)



## FIELDPRO™ MULTI-SPORT NET SYSTEM



Ball stop net system for lacrosse, field hockey, and other field sports. Ensure the safety of athletes, coaches, and spectators!

- (4) 4" heavy-walled aluminum uprights and ground sleeves
- Ground sleeve covers optional (FN-20-C)
- #36 knotted black nylon net with 1¾" sq. mesh
- Pulley system and corrosion-resistant hardware included
- 3 Year Limited Warranty: System

*Standard upright color is black. Custom colors available upon request for additional charge. Freight quote required.*

**15'H x 65'W**

FNMB-65 (EACH)



## PORTABLE FIELDPRO™ NET SYSTEM PACKAGE

*See (page 175) for more FieldPro™ Net System details.*





SGP-600

# **NOVA**<sup>TM</sup>

## Premiere Goal

### Goal Features:



European Backstays



4" round front frame



Net attachment around entire frame

European style all aluminum goal with the strength and durability to last. Top of the line goal that will compare and surpass the competition. Easy Track™ net attachment system is on the complete frame and bottom bases for easy installation of the net. NCAA, NFHS and FIFA compliant. Available as goal pair, or package.

**12 Year Limited Warranty** on Goal



# NOVA™ PREMIERE GOAL PACKAGES

# NOVA™

Package Includes:

- (2) NOVA™ Premiere Goals SGP-600
- (2) 5mm, 5½" hex mesh nets SN-HTTP-W, white  
SN-2BLKW, black/white  
SN-2BLUW, blue/white
- 4 World Cup™ Anchors SGA-50
- (2) NOVA™ Goal Wheel Kits NSGWK

- White Hex Net** SGP-600PKGWHI (PKG)
- Black Hex Net** SGP-600PKGBLK (PKG)
- Blue Hex Net** SGP-600PKGBLU (PKG)

Package Includes:



SGP-600PKGWHI



SGP-600PKGBLK



SGP-600PKGBLU



Wheel kits



World Cup™ anchors



Hex net (white)



Hex net (white/black)

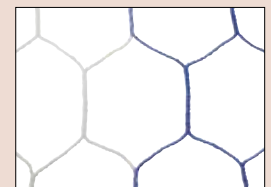

Hex net (white/blue)



Features the

**EASY TRACK™**  
Flush mounted Net Attachment System



## NOVA™ PREMIERE GOAL



- European style all aluminum extruded goal with white powder coat finish
- 4" extruded aluminum goal face with 2" x 4" base frame
- 1.7" aluminum European backstays
- Features Jaypro Sports flush mount Easy Track™ net attachment system with clips.
- Stainless steel hardware included
- Ground anchors (SGA-91), and nets (SN-HTTP-W) included
- Optional wheel kit (NSGWK) sold separately
- 8'H x 24'W x 4'B x 10'D
- 12 Year Limited Warranty

SGP-600 (PAIR)

# NOVA™

## Premiere Adjustable Goal



European style all aluminum goal designed with the ability to adjust the rear crossbar to fit perfectly under any football goal post. Top of the line goal that will compare and surpass the competition. NCAA, NFHS and FIFA compliant. Available as goal pair or package.

**12 Year Limited Warranty** on Goal

### Goal Features:



European Backstays



4" round front frame



Net attachment around  
entire frame



Adjustable Crossbar



# NOVA™ PREMIERE ADJUSTABLE GOAL PACKAGE

# NOVA™



Package Includes:

- (2) NOVA™ Premiere Adjustable Goals SGP-600AX
- (2) 5mm, 5½" hex mesh nets SN-2BLUW, blue/white
- 4 World Cup™ Anchors SGA-50
- (2) NOVA™ Goal Wheel Kits NSGWK

SGP-600AXPKG (PKG)

Features the

**EASY TRACK™**  
Flush mounted Net Attachment System

Package Includes:



SGP-600AX



Wheel kits



World Cup™ anchors

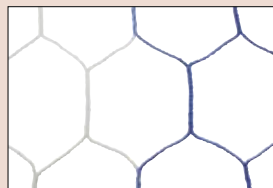

Hex net (white/blue)



Flush mounted net attachment



SGP-600AX

## NOVA™ PREMIERE ADJUSTABLE GOAL



Same as NOVA™ Premiere Goal (SGP-600) except with:

- Infinitely adjustable rear crossbar allows goal to fit under any football goal post
- No fixed settings and no fixed depth on crossbar (bottom bar adjusts from 4' to 8' deep)
- Anchor kits available for football goal post (SFGA-6, SFGA-5 or SFGA-4)
- Stainless steel hardware included
- Ground anchors (SGA-91), and nets (SN-HTTP-W) included
- Optional wheel kit (NSGWK) sold separately
- 8'H x 24'W x 4'B x 10'D
- 12 Year Limited Warranty

SGP-600AX (PAIR)





SGP-400 **ROUND**



SGP-760 **SQUARE**

## Classic Official Goals

Smart choice for both competition and recreational play. Available in all aluminum front faces: 4" round or 4" square. Equipped with 2" galvanized steel backstays for that classic soccer look. NCAA, NFHS and FIFA compliant. Available as goal pair, or package.

**12 Year Limited Warranty** on Goal

### Goal Features:



Galvanized backstays



Net attachment around entire frame



SGP-400 Round Goal



SGP-760 Square Goal



Mesh net



Auger anchors



World Cup™ anchors



Wheel kit



# CLASSIC OFFICIAL GOAL PACKAGES

Classic Package Includes:

- (2) Classic Official Round Goals **(or)** SGP-400
- (2) Classic Official Square Goals SGP-760
- (2) 4mm, 5½" sq. mesh white nets SND-8
- (4) Auger Anchors - 1 Set SAS-95
- (1) Classic Wheel Kit CSGWK

**Round Goal** SGP-400PKG (PKG)

**Square Goal** SGP-760PKG (PKG)

Deluxe Package Includes:

- (2) Classic Official Round Goals **(or)** SGP-400
- (2) Classic Official Square Goals SGP-760
- (2) 5mm, 5½" hex mesh white nets SN-HTTP-W
- (4) World Cup™ Anchors - 1 Set SGA-50
- (1) Classic Wheel Kit CSGWK

**Deluxe Round Package** SGP-400PKGD (PKG)

**Deluxe Square Package** SGP-760PKGD (PKG)



Features the

**EASY TRACK™**

Flush mounted Net Attachment System

## CLASSIC OFFICIAL GOALS

- Official size with white powder coat finish
- 4" round or square extruded aluminum frame with 2" galvanized steel backstays and rear crossbar
- Portable and semi-permanent models
- Wheel kit (CSGWK) sold separately

- Features Jaypro Sports flush mount Easy Track™ net attachment system with clips
- Ground anchors on SGP-400 & SGP-760 goals only (SGA-91), and net (SND-8) included
- 8'H x 24'W x 4'B x 10'D

### CLASSIC OFFICIAL ROUND GOAL



**Portable Goal** SGP-400 (PAIR)

**Semi-Permanent Goal with Galv. Steel Backstays** SGP-440 (PAIR)

**Semi-Permanent Goal with European Backstays** SGP-440EB (PAIR)

**Ground Sleeves for Semi-Perm Goal (set of 4)** SGP-445G (SET)

### CLASSIC OFFICIAL SQUARE GOAL



**Portable Goal** SGP-760 (PAIR)

**Semi-Permanent Goal with Galv. Steel Backstays** SGP-730 (PAIR)

**Semi-Permanent Goal with European Backstays** SGP-730EB (PAIR)

**Ground Sleeves for Semi-Perm Goal (set of 4)** SGP-735G (SET)





## TEAM OFFICIAL GOALS

### TEAM OFFICIAL SQUARE GOAL



- Official size with white powder coat finish
- 4" x 2" aluminum front face with 2" galvanized steel backstays and rear crossbar
- Backstays run back 10' for more stable base
- Features Jaypro Sports flush mount Easy Track™ net attachment system with clips



Features the  
**EASY TRACK™**  
 Flush mounted Net Attachment System

- Ground anchors (SAS-95) and nets (SND-8) included
- Wheel kit (CSGWK) sold separately
- 8'H x 24'W x 4'B x 10'D
- 3 Year Limited Warranty

SGP-110 (PAIR)



### TEAM OFFICIAL ROUND GOAL (SEMI-PERMANENT)

Powder coated white aluminum goal. Designed without backstays for permanent/semi-permanent installation!

- Features Jaypro Sports flush mount Easy Track™ net attachment system with clips
- 4" crossbar and uprights
- Nets (SEYL-24N), and net pegs (NP-25) included
- 8'H x 24'W
- 3 Year Limited Warranty
- *Aluminum ground sleeves with locking caps sold separately*

**Goal** SGP-220 (PAIR)

**Ground Sleeves (Set of 4)** SGP-445G (SET)





### NOVA™ SWIVEL WHEEL KIT



Attaches to any NOVA™ goal base (SGP-850, SGP-600 and NOVA™ club round and square), or any goal with a 2" x 4" base.

- (4) 10" swivel wheels
- Easy on/off with pull pin
- NOVA goals have pre-drilled holes in the base to accommodate for wheels
- 3 Year Limited Warranty

SGSWK (KIT)



### SOCCER GOAL CART

Swivel wheel goal carts allow goals to be moved in all directions with ease. Will transport any official or club soccer goal.

- 3 Year Limited Warranty

SGT-24 (PAIR)



### NOVA™ WHEEL KIT



Attaches to any NOVA™ goal base (SGP-850, SGP-600 and NOVA™ club round and square).

- (4) 10" no-flat wheels
- Quick and easy flip over wheel
- Kit equips 2 goals
- 3 Year Limited Warranty

NSGWK (KIT)



### CLASSIC WHEEL KIT



Attaches to goal base (SGP-760, SGP-400, SGP-110 and all Classic Club Round Goals).

- (4) 10" no-flat wheels
- No drilling of backstay pipe required
- Quick and easy flip over wheel
- Kit equips 2 goals
- 3 Year Limited Warranty

CSGWK (KIT)



## NOVA™ CLUB ROUND GOALS



White powder coat finish!

- 3" extruded aluminum frames with European backstays
- Multiple sizes available
- 4" sq. mesh white nets, augers (SAS-95), and stainless steel hardware included
- Features Jaypro Sports flush mount Easy Track™ net attachment system with clips
- Wheel kit (NSGWK) sold separately
- 12 Year Limited Warranty

# NOVA™

### Goal Features:



Net attachment around entire frame



Auger Anchors



Corner connection



European backstays

Size	Counter Weight	Item #	UoM
8'H x 24'W x 4'B x 9'D	150 LBS	RCG-24S	(SET)
7'H x 21'W x 3'B x 8'D	170 LBS	RCG-21S	(SET)
6½'H x 18½'W x 2'B x 6'D	240 LBS	RCG-18S	(SET)
6½'H x 12'W x 2'B x 6'D	240 LBS	RCG-12S	(SET)
4½'H x 9'W x 2'B x 5'D	N/A	RCG-9S	(SET)
4'H x 6'W x 2'B x 5'D	N/A	RCG-6S	(SET)



Features the

**EASY TRACK™**  
Flush mounted Net Attachment System





## CLASSIC CLUB ROUND GOALS



White powder coat finish!

- 3" extruded aluminum frames with galvanized steel backstays
- Multiple sizes available (galvanized steel rear crossbars on three largest sizes)
- 4" sq. mesh white nets, augers (SAS-95), and stainless steel hardware included
- Features Jaypro Sports flush mount Easy Track™ net attachment system with clips
- Wheel kit (CSGWK) sold separately
- 12 Year Limited Warranty

Features the

**EASY TRACK™**  
Flush mounted Net Attachment System



## Goal Features:



Net attachment around entire frame



Auger Anchors



Corner connection



Classic backstays

Size	Counter Weight	Item #	UoM
8'H x 24'W x 4'B x 9'D	140 LBS	CC24S	(SET)
7'H x 21'W x 3'B x 8'D	160 LBS	CC21S	(SET)
6½'H x 18½'W x 2'B x 6'D	240 LBS	CC18S	(SET)
6½'H x 12'W x 2'B x 6'D	240 LBS	CC12S	(SET)
4½'H x 9'W x 2'B x 5'D	N/A	CC9S	(SET)
4'H x 6'W x 2'B x 5'D	N/A	CC6S	(SET)

Age Group	Recommended Goal Size	Maximum Ball Size	Minimum Players/Team
U-13	8' x 24'	5	11 vs 11
U-12	Up to 6½' x 18½'	4	9 vs 9
U-11	Up to 6½' x 18½'	4	9 vs 9
U-10	Up to 6½' x 18½'	4	7 vs 7
U-9	Up to 6½' x 18½'	4	7 vs 7
U-8	Up to 4' x 6'	3	4 vs 4
U-6/U-7	Up to 4' x 6'	3	4 vs 4





## DELUXE OFFICIAL SOCCER/FOOTBALL GOAL



Ideal for multi-purpose athletic facilities.

- Designed for permanent or semi-permanent installation
- 4" round extruded aluminum soccer uprights and crossbars, powder coated white
- 2" removable soccer backstays
- 2 3/8" aluminum football uprights
- Football Uprights - 10' tall
- Features Jaypro Sports flush mount Easy Track™ net attachment system with clips
- Nets (SND-8 recommended), post padding, and ground sleeves sold separately
- Soccer Dimensions - 8' x 24' x 4' x 10'
- 3 Year Limited Warranty

- Goal w/Standard Backstays**      FBSC-240 (PAIR)
- Goal w/European Backstays**      FBSC-240EB (PAIR)

## Goal Features:



Football



Net attachment around entire frame



Gusset

Features the **EASY TRACK™**  
Flush mounted Net Attachment System

## ALUMINUM GROUND SLEEVES



- Aluminum ground sleeves with locking caps for semi-permanent installation
- 3 Year Limited Warranty

- Set of 4**      SGP-445G (SET)



Standard Backstays





FBSC-120 shown with net



Football Goal

## OFFICIAL SOCCER/FOOTBALL GOAL



- Meets high school regulations for competition football and soccer
- Designed for permanent or semi-permanent installation
- Football uprights can be installed at high school (23'4") or collegiate (18'6") widths and removed for soccer play
- 2" x 4" goal support uprights made of 14 gauge steel tubing
- 2" square steel tube football uprights are 10' tall
- "Money Clip" attachments included
- Ground sleeves (SGP-722G), nets (SEYL-24NHP) and backstays sold separately
- Ideal for shared football and soccer fields
- Soccer Dimensions - 8' x 24'
- 3 Year Limited Warranty

**Goal** FBSC-120 (PAIR)

## GROUND SLEEVES

- 24" ground sleeves and 4 locking caps included
- 3 Year Limited Warranty

**Set of 4** SGP-722G (SET)





PCG-800 shown with net and powder coated white

## PORTABLE PRACTICE FOOTBALL/SOCCER COMBO GOAL (HIGH SCHOOL)



- Lightweight and stable
- 2" galvanized steel construction
- Double no-flat wheels for easy transport
- Football Uprights - 10' tall
- Available in white (for an additional charge)
- Net and wind streamers sold separately
- Soccer Dimensions - 8' x 24'
- Football Crossbar - 23'4" wide
- 3 Year Limited Warranty on Goal

**Goal** PCG-800 (EACH)

**Powder Coat**  
PNT-1 (EACH)

**Replacement Net - 8' x 24' x 0' x 8'**  
SEYL-24NHP (EACH)

### POWDER COAT OPTION



White



Double no-flat wheels





## PORTABLE PRACTICE FOOTBALL GOAL



- 2" galvanized steel H-frame with double no-flat wheels
- 20'H x 23'4"W (High School)
- 20'H x 18'6"W (Collegiate)
- Available in three colors (*specify when ordering*)
- 3 Year Limited Warranty

<b>High School</b>	PPG-4HS (EACH)
<b>Collegiate</b>	PPG-4C (EACH)
<b>Powder Coat</b>	PNT-1 (EACH)

### POWDER COAT OPTIONS



## H-FRAME FOOTBALL GOAL POST



- Designed for permanent installation
- 4" heavy-walled aluminum tubing
- Uprights extend 10' above crossbar
- Powder coated in White. Other colors available (*Yellow or Pro Yellow*)
- 20'H x 23'4"W
- 3 Year Limited Warranty

<b>Goal</b>	HFGP-3 (PAIR)
<b>Powder Coat</b>	PNT-1 (EACH)

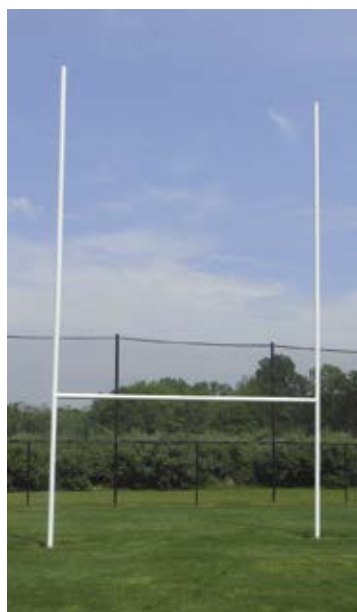

## OFFICIAL RUGBY GOAL



- Designed for permanent or surface mount installation
- 32'H x 18'4"W
- Uprights extend 22' above crossbar and made with 4" Sch 40 aluminum tubing
- Crossbar is 4" aluminum tubing
- Tough powder coated white finish
- 3 Year Limited Warranty

<b>Permanent Goal</b>	RGP-3 (PAIR)
<b>Surface Mount Pad</b>	RGP-3H (PAIR)
	RGP-SQP (EACH)

## RUGBY GOAL PAD

Custom lettering and graphics available.

*Call customer service at 800-243-0533 for pricing and artwork details.*









## SOCCKER SHELTER



- Powder coated steel frame with removable polyester top for quick and easy (dis)assembly
- 4 auger stakes for grass or 4 sand bags (filled in the field) for turf anchoring (specify when ordering)
- Wheel kit included
- Player benches sold separately, see (page 188)
- 6'4"H x 17'W x 5'D

Call for freight quote.

SCSHLT-X (EACH)

Item #	Color
SCSHLT-G	Gray
SCSHLT-NB	Navy Blue
SCSHLT-B	Royal Blue
SCSHLT-R	Red
SCSHLT-BK	Black
SCSHLT-M	Maroon
SCSHLT-GR	Green

### Upgrade your shelter with any of the following options:

#### Shelter Wind Flap

- 17' x 2' mesh fabric sewn into cover with wind flap added to rear of shelter

SCSHLT-WF (EACH)

#### 2' x 2' Team Logo

- Sewn on side panel

SCSHLT-LOGO22 (EACH)

#### 3" Team Lettering

- Letters are sewn across front panel

SCSHLT-LTR (EACH)

#### 4' x 4' Team Logo

- Sewn on rear panel

SCSHLT-LOGO44 (EACH)

Vector files required for team logos. Other file formats require an art charge. Call customer service for additional options.



## REFEREE/SCOREKEEPER SHELTER



- Easy to move and assemble
- Powder coated steel frame
- Removable polyester cover
- Same lettering and logo options listed above are offered
- 6½'H x 8½'L x 4'8"D

Call for freight quote.

RSHLT-X (EACH)

Item #	Color
RSHLT-G	Gray
RSHLT-NB	Navy Blue
RSHLT-B	Royal Blue
RSHLT-R	Red
RSHLT-BK	Black
RSHLT-M	Maroon
RSHLT-GR	Green

## DELUXE OFFICIAL FUTSAL GOAL



- 1 official size goal with white powder coat finish
- 3" round aluminum goal face and base with extruded channel which features Jaypro Sports flush mount Easy Track™ net attachment system with clips
- 1 1/4" round heavy-walled aluminum backstays
- Polyethylene white net with 4" sq. mesh (FSG67910N) included
- Stainless steel hardware included
- 6'7"H x 9'10"W x 3'3"D
- Non-marring floor protectors included
- 3 Year Limited Warranty on Goal



**EASY TRACK™**  
Goal face and base

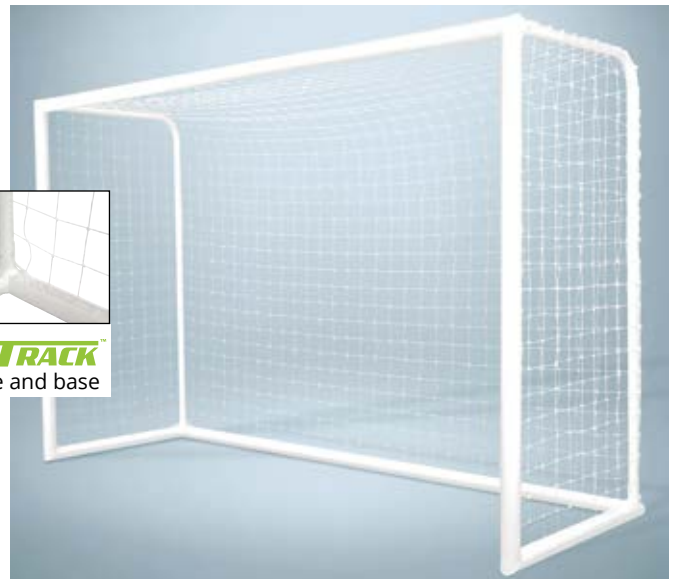

**Goal** FSG-1 (EACH)

**Replacement Net** FSG67910NHP (EACH)

## OFFICIAL FUTSAL GOAL



- 1 portable goal with white powder coat finish
- 3" extruded aluminum front face of frame which features Jaypro Sports flush mount Easy Track™ net attachment system with clips
- 6'7"H x 9'10"W x 3'3"D
- (1) 4" sq. mesh net
- Non-marring floor protectors included
- 3 Year Limited Warranty on Goal

**Goal** FSG-2 (EACH)

**Replacement Net** FSG67910NHP (EACH)

**Wheel Kit** FSGWK (KIT)



**EASY TRACK™**  
Goal face

## INDOOR/OUTDOOR FOLDING GOAL



For competitive indoor play and as an outdoor training/youth goal.



- Indoor/outdoor use
- 2" zinc undercoated steel frame powder coated white
- 1 15/16" backstays fold without removing net
- 4" sq. mesh net
- Non-marring floor protectors included
- 7'H x 12'W x 4'D
- 1 Year Limited Warranty on Goal

See (pages 48-49) for ground anchors for outdoor use.

**Goal** SFG-14HP (EACH)

**Replacement Net** SFG-14NHP (EACH)







### PORTABLE SHORT-SIDED SOCCER GOALS

- 1<sup>15</sup>/<sub>16</sub>" galvanized steel frame powder coated white
- All-welded side frames and rear ground crossbars for increased strength and durability
- Snap pins lock frame in place for added safety
- Folds for easy transport and storage
- 2.5mm twisted net with 4" sq. mesh
- Ground anchors and net ties included
- Optional Floor Protection Kit (PSS-4FT) sold separately to use indoors
- 1 Year Limited Warranty on Goal

#### FOR 4 VS 4 PLAY:

**6'H x 12'W x 31"D Goal** PSS-612 (EACH)  
**Replacement Net** PSS-612N (EACH)

**6'H x 8'W x 31"D Goal** PSS-608 (EACH)  
**Replacement Net** PSS-608N (EACH)

**5'H x 10'W x 34"D Goal** PSS-510 (EACH)  
**Replacement Net** PSS-510N (EACH)

#### FOR 3 VS 3 PLAY:

**4'H x 6'W x 24"D Goal** PSS-406 (EACH)  
**Replacement Net** PSS-406N (EACH)



### GOAL RUNNER™



- For indoor/outdoor youth play
- Steel frame folds flat for compact storage
- Non-marking front wheels for easy transport
- Durable knotless nylon net with vinyl sleeves
- Hook-and-loop closures (no lacing required)
- Available in 3 sizes
- 3 Year Limited Warranty on Goal

**2'H x 3'W - Small** STG-23 (EACH)  
**Replacement Net** STG-23N (EACH)

**3'H x 4'W - Medium** STG-34 (EACH)  
**Replacement Net** STG-34N (EACH)

**4'H x 6'W - Large** STG-46 (EACH)  
**Replacement Net** STG-46N (EACH)



### FLOOR PROTECTOR KIT

Ideal for using Portable Short-Sided Soccer Goals indoors.

- Help protect gymnasium floor from being scratched or damaged
- Kit includes self-threading screws with 4 rubber feet
- 1 Year Limited Warranty

PSS-4FT (KIT)

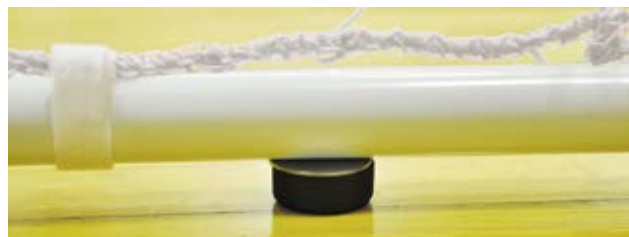





### QUICK SET-UP GOAL



Great for any league or backyard use.

- Sets up in minutes with quick release push-pins
- 2" aluminum frame
- Goal width adjusts to 8', 16' or 24' x 8'H
- Net, 6 net pegs, indoor floor pads and carry bag included
- 3 Year Limited Warranty on Goal

**Goal** SEYL-824 (EACH)

**Replacement Net** SEYL-24NHP (EACH)



### SOCCER POP-UP TRAINERS

- Durable and safe lightweight pop-up goals
- Fiberglass rod frame w/steel spring corners and heavy-duty net
- Equipped with anchoring pegs to ensure stability
- Folds down to 1" flat oval
- Available in 2 sizes
- Zipper nylon bag with handles included
- 1 Year Limited Warranty on Goal

**2½'H x 4'W x 2½'D Red** SGPU4830R (PAIR)

**3'4"H x 6'W x 3'4"D Blue** SGPU7240B (PAIR)



## RUGGED PLAY GOAL

For precision shooting drills or short-sided games.

- Quick release push-pins make break down easy
- 2" galvanized steel frame
- 2.5mm white polyethylene net with 4" sq. mesh
- Includes rubber feet to protect gymnasium floor
- 4'H x 8'W x 4'D
- 3 Year Limited Warranty on Goal

**Goal** SMG-8HP (EACH)

**Replacement Net** SMG-8NHP (EACH)



## TWO-FOR-YOUTH GOAL



- Two sizes in one (4' x 6' or flip to 3' x 6')
- Easy quick release push-pin assembly
- 1½" aluminum frame powder coated white
- Knotless black mesh net
- Hook-and-loop net attachment
- 3 Year Limited Warranty on Goal

**Goal** MPG-46 (EACH)

**Replacement Net** MPG-46N (EACH)



## WORLD CUP™ ANCHOR



- Tank style anchor has 4¾"W x 3¼"H opening designed to fit over any round or flat rear crossbar
- Hard plastic shell will not crack when filled in the field with 50 lbs. concrete, or 39 lbs. sand
- Built-in carry handle and stackable design for convenient storage
- Bright yellow color for visibility and safety
- 8½"H x 12"W
- 1 Year Limited Warranty

**Set of 4** SGA-50 (SET)

**Single** SGA-51 (EACH)



See below for ASTM counterweight requirements for your specific goal.

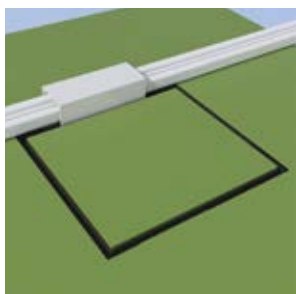
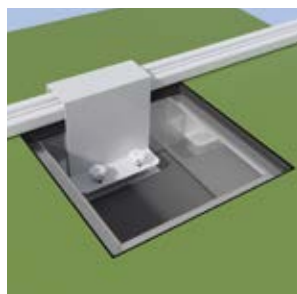

Used on rectangle or round rear crossbar

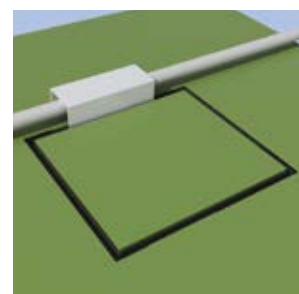
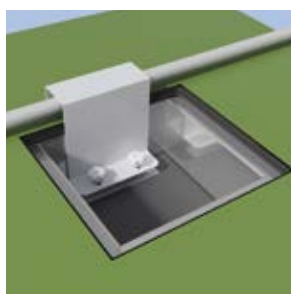

## GROUND SOCCER ANCHOR

- Low profile inground anchor, constructed of aluminum
- Adjustable clamp fits over and secures most soccer rear crossbars
- Clamp support rods anchored directly into concrete foundation

- Removable clamp that stores inside box, when not in being used
- Flush mounted cover, compatible with both synthetic infill turf or natural grass fields

SGA-AF (EACH)



## SOCCER/FOOTBALL ANCHOR KIT



See page 54 for details on this anchor.

- 6⅝" OD Gooseneck**
- 5⅞" OD Gooseneck**
- 4½" OD Gooseneck**

- SFGA-6 (KIT)
- SFGA-5 (KIT)
- SFGA-4 (KIT)

## SOCCER GOAL COUNTERWEIGHT REQUIREMENTS

Visit our website for the latest information

[www.jaypro.com/ASTM](http://www.jaypro.com/ASTM)





# Check It - Secure It - Test It - Respect It

Jaypro Sports is committed to safety on the field. Because of this we have created the Secure 4 Safety Program which promotes soccer goal safety.



SWB-451



SWB-451W

## SANDBAG ANCHOR



- Fill sandbag in the field with 50 lbs. of dry sand
- Choose from steel carry handle or nylon strap design
- Custom colors on orders of 10 or more (SWB-451 only)
- 1 Year Limited Warranty

**w/Steel Handle** SWB-451 (EACH)

**w/Steel Handle - Set of 4** SWB-454 (SET)

**w/Nylon Handle** SWB-451W (EACH)

**w/Nylon Handle - Set of 4** SWB-454W (SET)



## IN-GROUND ANCHOR

- Securely anchors any portable NOVA™ goal or existing goal with minor modification
- Will not pull out or slide off the base frame
- Includes 2 anchors for one goal
- 1 Year Limited Warranty

SGA-60 (SET)

## Counterweight Requirements

Visit our website for the latest information on ASTM counterweight requirements for your specific goal.

[www.Jaypro.com/ASTM](http://www.Jaypro.com/ASTM)

## AUGER ANCHOR

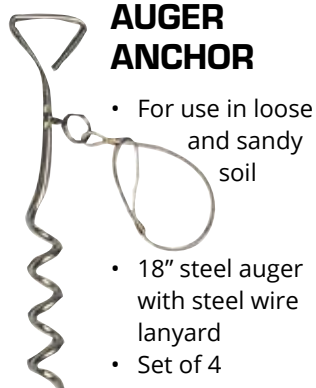

- For use in loose and sandy soil
- 18" steel auger with steel wire lanyard
- Set of 4

SAS-95 (SET)

## J-HOOK STAKE



- For use in firm and compressed soil
- 18" durable "J" style steel stake with steel wire lanyard
- Set of 4

SGA-91 (SET)

## SPIKE ANCHOR



- For use in firm and tightly compacted soil
- 18" long 3/4" galvanized steel spike with steel wire lanyard
- Set of 4

SS-18 (SET)

## YOUTH GOAL ANCHOR



- 3/8" dia. and 15 1/2" long
- Not appropriate for official goals
- Set of 4

217RP (SET)

2 Tone Hexagon

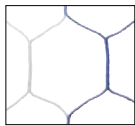

Durable Twisted & Knotted



Durable Braided & Knotted

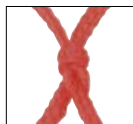

	Item #	Size	Mesh	Twine	Color	UoM
<b>OFFICIAL</b>	SOC-6*	8' x 24' x 4' x 10'	5½" sq.	6mm Braid	WHITE	(PAIR)
	SND-8*	8' x 24' x 4' x 10'	5½" sq.	4mm Braid	WHITE	(PAIR)
	SN-40B*	8' x 24' x 4' x 10'	5½" sq.	4mm Braid	BLUE	(PAIR)
	SN-40Y*	8' x 24' x 4' x 10'	5½" sq.	4mm Braid	YELLOW	(PAIR)
	SGP-850N*	8' x 24' x 6½' x 7½'	4¾" sq.	4mm Braid	WHITE	(PAIR)
	SN-HTTP-W*	8' x 24' x 4' x 10'	5½" hex	5mm Braid	WHITE	(PAIR)
	SGP-550N*	8' x 24' x 6' x 6' Box	5½" hex	5mm Braid	WHITE	(PAIR)
	SN-6BLKW*	8' x 24' x 6' x 6' Box	5½" hex	5mm Braid	WHITE BLACK	(PAIR)
	SN-2BLUW*	8' x 24' x 4' x 10'	5½" hex	5mm Braid	WHITE BLUE	(PAIR)
	SN-2GRNW*	8' x 24' x 4' x 10'	5½" hex	5mm Braid	WHITE GREEN	(PAIR)
	SN-2REDW*	8' x 24' x 4' x 10'	5½" hex	5mm Braid	WHITE RED	(PAIR)
	SN-2BLKW*	8' x 24' x 4' x 10'	5½" hex	5mm Braid	WHITE BLACK	(PAIR)
<b>CLUB</b>	SEYL-24NHP*	8' x 24' x 0' x 8'	5½" sq.	2.5mm Twist	WHITE	(EACH)
	SCN-24*	8' x 24' x 4' x 10'	4" sq.	3mm Twist	WHITE	(PAIR)
	SCN-21	7' x 21' x 3' x 8'	4" sq.	3mm Twist	WHITE	(PAIR)
	SCN-18	6½' x 18½' x 2' x 6'	4" sq.	3mm Twist	WHITE	(PAIR)
	SCN-12	6½' x 12' x 2' x 6'	4" sq.	3mm Twist	WHITE	(PAIR)
	SCN-9	4½' x 9' x 2' x 5'	4" sq.	3mm Twist	WHITE	(PAIR)
	SCN-6	4½' x 6' x 2' x 5'	4" sq.	3mm Twist	WHITE	(PAIR)
<b>YOUTH</b>	SFG-14NHP	7' x 12' x 1' x 4'	4" sq.	2.5mm Twist	WHITE	(EACH)
	SMG-8NHP	4' x 8' x 0' x 4'	4" sq.	2.5mm Twist	WHITE	(EACH)
	PSS-612N	6' x 12' x 0' x 31"	4" sq.	2.5mm Twist	ORANGE	(EACH)
	PSS-608N	6' x 8' x 0' x 31"	4" sq.	2.5mm Twist	ORANGE	(EACH)
	PSS-510N	5' x 10' x 0' x 34"	4" sq.	2.5mm Twist	ORANGE	(EACH)
	PSS-406N	4' x 6' x 0' x 24"	4" sq.	2.5mm Twist	ORANGE	(EACH)

\* Official Size Nets - Nets: 1 Year Limited Warranty





## EASY TRACK™ NET CLIPS

- Rigid plastic clips fit securely and flush into Easy Track™ net attachment system so net won't slip
- 100 clips in a bag (enough clips for a pair of goals)
- 1 Year Limited Warranty

<b>White</b>	EC-824 (BAG)
<b>Pink</b>	EC-824PK (BAG)
<b>Black</b>	EC-824BK (BAG)
<b>Red</b>	EC-824RD (BAG)
<b>Blue</b>	EC-824BL (BAG)

Jaypro Sports Easy Track™ net clips are compatible with other soccer goal brands.

## HOOK-AND-LOOP CLOSURE STRIPS



Convenient hook-and-loop closure strips secure net without lacing.

- 1 Year Limited Warranty on Goal

### Kit of 20

**Fits up to 2" tubing**      SINT-20 (KIT)

### Kit of 25

**Fits up to 2" tubing**      SINT-25 (KIT)

### Kit of 40

SINT-40 (KIT)

### Kit of 60

SINT-60 (KIT)

*SINT-20 fits up to (1) 12' goal. SINT-25 fits up to (1) 24' goal.  
SINT-40 fits up to (2) 12' goals. SINT-60 fits up to (2) 24' goals.*



## BUNGEE NET FASTENERS

- (30) 6" long bungees
- Designed to secure nets to any soccer goal with a 3" or smaller post
- Two bags required for (STGRB718)
- Three bags required for (STGRB824)
- 1 Year Limited Warranty

**30 Count**      STGRB718B (BAG)



## HOOK-AND-LOOP CLOSURE

- Closure roll is 1½" W x 75' L
- Enough to fit a pair of official goals
- 1 Year Limited Warranty

VNS-25 (SET)



## NET CLIPS

- Treated steel "money clip" design
- For use with existing pre-drilled 5/16" dia. holes
- 70 clips in a kit (enough for a pair of 8' x 24' goals)
- Plastic retainers included with snap plugs

SNT-180 (KIT)

- Self-drilling screws for aluminum goals
- Space at 14"
- 70 clips in a kit (enough for a pair of 8' x 24' goals)
- 1 Year Limited Warranty

SNT-200 (KIT)



## NET PEGS

- Prevent balls from passing under net
- Set of 25
- 1 Year Limited Warranty

NP-25 (SET)

## PORTABLE TRAINING GOAL

- 2" lightweight aluminum frame with stabilizing base plates
- 4" sq. mesh nylon net and carry bag included
- 3 Year Limited Warranty

**7½'H x 18'W - Medium** STG-718 (EACH)

**Replacement Net** STG-718N (EACH)

**8'H x 24'W - Large** STG-824 (EACH)

**Replacement Net** STG-824N (EACH)

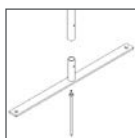

### Stable Anchored Base

The powder coated white ground base assembly lies flat on the ground. The ground stake is inserted through the middle of the base to anchor it to the ground. The upright is placed over a sleeve on the base assembly, resulting in a stable goal with no visible anchor to cause a tripping hazard.

## SOCCER REBOUNDER

- 2" lightweight aluminum frame with stabilizing base plates
- 1½" sq. mesh net, bottom crossbar, and powder coat finish
- Bungee net attachments and carry bag included
- (2) bags required for Med. Rebounder (STGRB718)
- (3) bags required for the Lg. Rebounder (STGRB824)
- 3 Year Limited Warranty

**7½'H x 18'W - Medium** STGRB718 (EACH)

**Replacement Net** RB718N (EACH)

**8'H x 24'W - Large** STGRB824 (EACH)

**Replacement Net** RB824N (EACH)

### Replacement Bungee Net Fasteners

STGRB718B (BAG)



## EQUIPMENT CARRY BAGS

Heavy-duty black bags with reinforced zipper.

- Large - Holds the Quick-Set Up Goal (SEYL-824)
- Medium - Holds Portable Training Goal and Soccer Rebounder
- Small - Holds Two-For-Youth Goal (MPG-46) and other items
- 1 Year Limited Warranty

**15"Dia. x 105"L - Large Bag** ECB-LG (EACH)

**13"Dia. x 100"L - Medium Bag** ECB-MD (EACH)

**11"Dia. x 78"L - Small Bag** ECB-SM (EACH)



## BUNGEE NET FASTENERS

- (30) 6" long bungees
- Designed to secure nets to any soccer goal with a 3" or smaller post
- Two bags required for Medium Soccer Rebounder (STGRB718)
- Three bags required for the Large Soccer Rebounder (STGRB824)
- 1 Year Limited Warranty

**30 Count** STGRB718B (BAG)



## TURF FLAG



### PREMIUM CORNER FLAGS & BASES

- Set of 4 includes: 4 poles, 4 flags and 4 black rubber bases
- Official 1" dia. x 5' tall PVC poles
- Indoor/outdoor
- 1 Year Limited Warranty

RBF-4 (SET)



### FLAG BASE BAG

- Vinyl carry bag holds 4 bases
- 14"H x 12"W x 12"D
- 1 Year Limited Warranty

RBF-BASE (EACH)

## FLEXIBLE GRASS FLAG

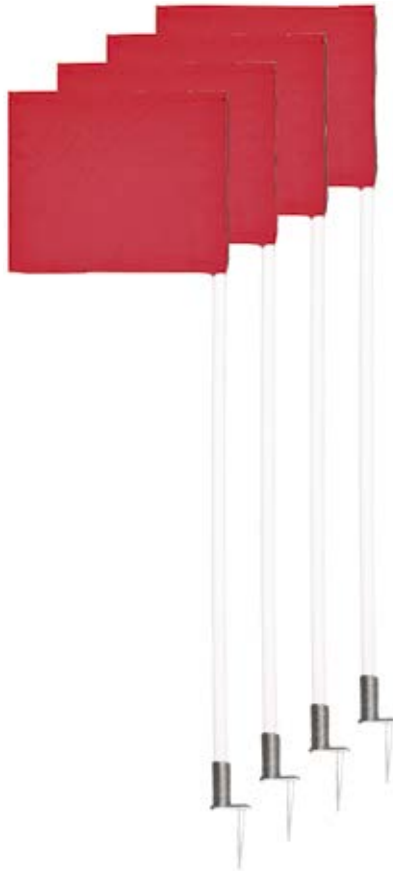

### DELUXE CORNER FLAG

- Set of 4
- 1" x 60" tall thick PVC poles with red flag (RBF-FLAG)
- Flexible spring loaded base
- 1 Year Limited Warranty

DCF-255 (SET)

## STATIONARY GRASS FLAG

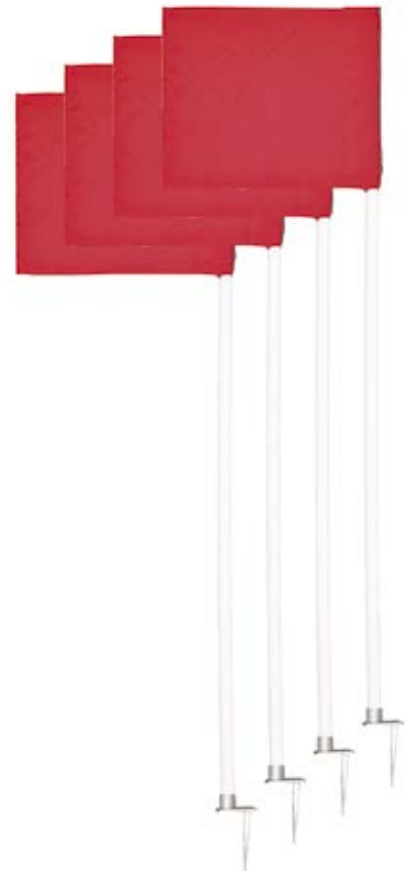

### OFFICIAL CORNER FLAG

- Set of 4
- 1" x 60" tall thick PVC poles with red flag (RBF-FLAG)
- Stationary base
- 1 Year Limited Warranty

DCF-251 (SET)



CFCB

### CORNER FLAG BAG

- Convenient storage bag carries up to 8 flags
- Constructed of washable black vinyl
- 1 Year Limited Warranty

CFCB (EACH)



RBF-FLAG

### REPLACEMENT FLAGS

- Set of (4) 12"H x 13½"W red nylon flags
- 1 Year Limited Warranty

RBF-FLAG (SET)



### PREMIUM COACHING STICKS & BASES

- Set of 6 includes: 6 poles and 6 black rubber bases
- Official 1" dia. x 5' tall PVC poles
- Each base weighs over 7 lbs.
- Indoor/outdoor
- 1 Year Limited Warranty

RBCS-6 (SET)



### SOCCER POST PAD

- Pre-formed cylindrical pad for 3" upright
- Will not affect ball rebound off post
- 6'H x 4½" dia. x 1" thick
- 1 Year Limited Warranty

Set of 2 SPP-3 (SET)



### SOCCER/FOOTBALL ANCHOR KIT



- Fastens the soccer goal rear crossbar to a football goal gooseneck
- 3 Year Limited Warranty



6<sup>5</sup>/<sub>8</sub>" OD Gooseneck  
 5<sup>9</sup>/<sub>16</sub>" OD Gooseneck  
 4<sup>1</sup>/<sub>2</sub>" OD Gooseneck

SFGA-6 (KIT)  
 SFGA-5 (KIT)  
 SFGA-4 (KIT)



### FIELD ID MARKER

- 14" x 14" vinyl marker with corner grommets
- 1 Year Limited Warranty

*Specify color & number when ordering.*

FIM-14 (EACH)







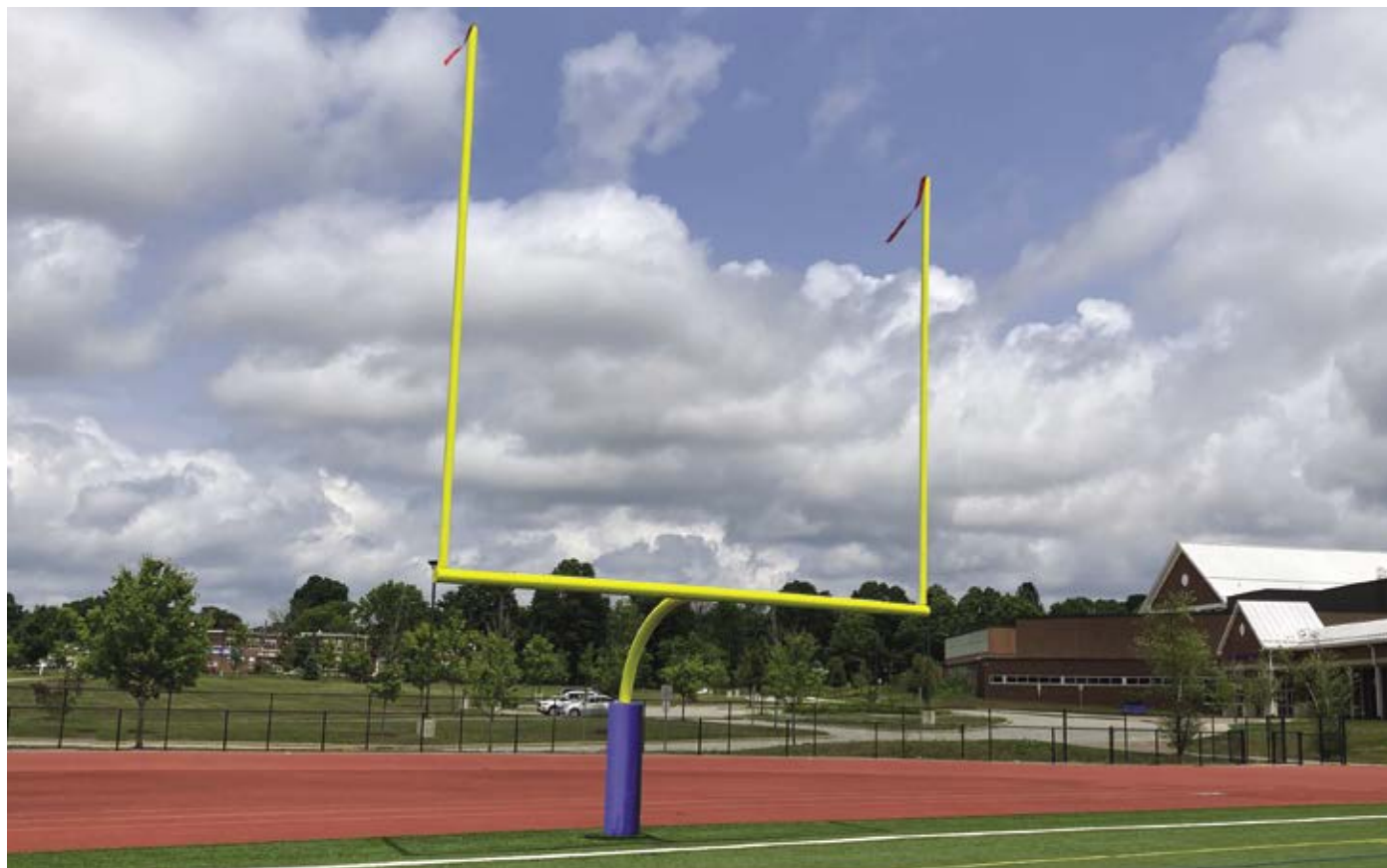

**High School: 23' 4"W - Semi-Permanent / Permanent**

Offset	Uprights	Item #	UoM
6'	20'	FBGP-520XX	(PAIR)
6'	30'	FBGP-530XX	(PAIR)
8'	20'	FBGP-820XX	(PAIR)
8'	30'	FBGP-830XX	(PAIR)

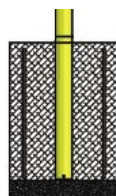

Semi-Permanent / Permanent

**High School: 23' 4"W - Leveling Plate**

Offset	Uprights	Item #	UoM
6'	20'	FBGP-420XX	(PAIR)
6'	30'	FBGP-430XX	(PAIR)
8'	20'	FBGP-920XX	(PAIR)
8'	30'	FBGP-930XX	(PAIR)

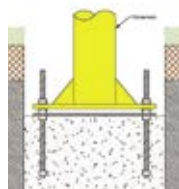

Leveling Plate

**Max-1™ Features:**

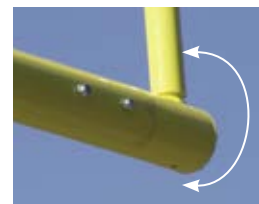

Adjustable in two directions

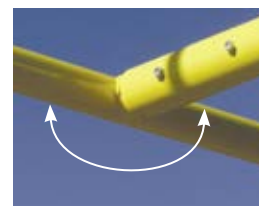

**Collegiate: 18' 6"W - Semi-Permanent / Permanent**

Offset	Uprights	Item #	UoM
6'	20'	FBGP-520CXX	(PAIR)
6'	30'	FBGP-530CXX	(PAIR)
8'	20'	FBGP-820CXX	(PAIR)
8'	30'	FBGP-830CXX	(PAIR)

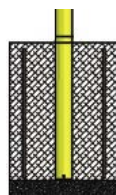

Semi-Permanent / Permanent

**Collegiate: 18' 6"W - Leveling Plate**

Offset	Uprights	Item #	UoM
6'	20'	FBGP-420CXX	(PAIR)
6'	30'	FBGP-430CXX	(PAIR)
8'	20'	FBGP-920CXX	(PAIR)
8'	30'	FBGP-930CXX	(PAIR)

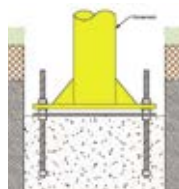

Leveling Plate

**POWDER COAT COLORS:**



WHITE (WH)



YELLOW (YW)



PRO YELLOW (PY)



## MAX-1™ ALUMINUM FOOTBALL GOAL POSTS



All aluminum goal posts available in high school and collegiate official sizes.

- 6½" crossbar and gooseneck available with 6' or 8' offset
- 4" uprights available in 20' or 30' heights
- 30' uprights are two-piece (Single-piece available upon request)
- Adjustable in two directions ensures crossbar and uprights are level and plumb
- Permanent/semi-permanent or adjustable leveling plate installation
- Includes wind streamers
- Ground sleeves for semi-permanent installation sold separately
- 5 Year Limited Warranty

8' offset perfect for multi-purpose fields can be used with soccer goals SGP-600AX, SGP-400, SGP-760, and CC24S.

**White, Yellow or Pro Yellow powder coat options.**

## FOOTBALL HINGE KIT

Allows any surface-mounted MAX-1™ football goal to be lowered and dismantled from ground level by a maintenance crew. Ideal for multi-purpose facilities!

- Opposing pull pins offer easy separation of hinge plates
- Required access frame and cover (FBGPAF-2) sold separately
- 3 Year Limited Warranty



FBHG-1 (EACH)

## STANDARD GROUND SLEEVES



Allows for semi-permanent installation.

- 3 Year Limited Warranty

**6½" Post - Max-1**  
FBSLV8 (PAIR)



## ACCESS FRAMES AND COVERS



For use with semi-permanent goals requiring removal from grass or turf fields.

- Aluminum, pressure-treated plywood, and artificial turf design
- 2 frames and 2 turf covered half plug plates included
- Optional full covers available
- 3 Year Limited Warranty



**Goals w/ Leveling Plate**  
18" x 18" x 6½" FBGPAF-1 (PAIR)

**Goals w/ Hinge Kit on Max-1™**  
26" x 26" x 10" FBGPAF-2 (PAIR)



Optional full covers available

## WIND STREAMERS



(4) 42"L x 4"W streamers with grommets and mounting hardware.

- 1 Year Limited Warranty

**Red** WS-42RD (SET OF 4)  
**Orange** WS-42OR (SET OF 4)



## MAX-1™ EXPANDABLE CROSSBARS

Telescoping design adjusts crossbar width for official use at 23' 4" (high school) and 18' 6" (collegiate). Anti-rotation feature holds uprights in place allowing adjustment by one person.

### Expandable: 18' 6" - 23' 4"W - Semi-Permanent / Permanent

Offset	Uprights	Item #	UoM
6'	20'	FBGP-520AX	(PAIR)
8'	20'	FBGP-820AX	(PAIR)

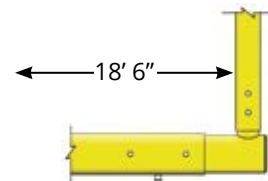

### Expandable: 18' 6" - 23' 4"W - Leveling Plate

Offset	Uprights	Item #	UoM
6'	20'	FBGP-420AX	(PAIR)
8'	20'	FBGP-920AX	(PAIR)

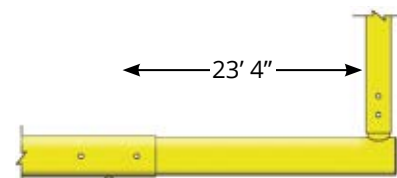
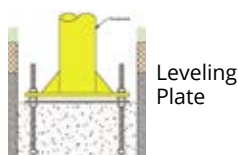



**High School: 23' 4"W - Semi-Permanent / Permanent**

Offset	Uprights	Color	Gooseneck	Item #	UoM
5'	20'	Yellow	4½"	FBGP-620YW	(PAIR)
5'	20'	White	4½"	FBGP-620	(PAIR)
6'	20'	Yellow	5⅞"	FBGP-720YW	(PAIR)
6'	20'	White	5⅞"	FBGP-720	(PAIR)

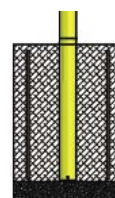

Semi-Permanent / Permanent

**High School: 23' 4"W - Leveling Plate**

Offset	Uprights	Color	Gooseneck	Item #	UoM
5'	20'	Yellow	4½"	FBGP-600YW	(PAIR)
5'	20'	White	4½"	FBGP-600	(PAIR)
6'	20'	Yellow	5⅞"	FBGP-700YW	(PAIR)
6'	20'	White	5⅞"	FBGP-700	(PAIR)

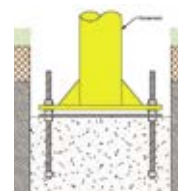

Leveling Plate

**Collegiate: 18' 6"W - Semi-Permanent / Permanent**

Offset	Uprights	Color	Gooseneck	Item #	UoM
6'	20'	Yellow	5⅞"	FBGP-720CYW	(PAIR)
6'	20'	White	5⅞"	FBGP-720C	(PAIR)

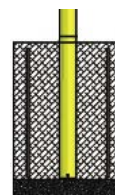

Semi-Permanent / Permanent

**Collegiate: 18' 6"W - Leveling Plate**

Offset	Uprights	Color	Gooseneck	Item #	UoM
6'	20'	Yellow	5⅞"	FBGP-700CYW	(PAIR)
6'	20'	White	5⅞"	FBGP-700C	(PAIR)

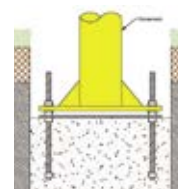

Leveling Plate



## STEEL FOOTBALL GOAL POSTS



Steel goal posts available in high school and collegiate official sizes.

- 4½" with 5' offset or 5¾" with 6' offset models
- 2¾" aluminum uprights, steel gooseneck and crossbar
- Adjustable in two directions ensures crossbar and uprights are level and plumb
- Permanent/semi-permanent or adjustable leveling plate installation
- Includes wind streamers
- Ground sleeves for semi-permanent installation sold separately
- 5 Year Limited Warranty

White or Yellow powder coat options.

### Goal Features:

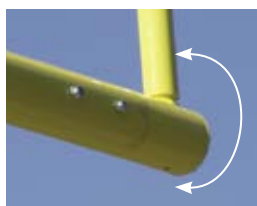

Adjustable in two directions

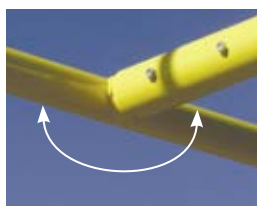

### POWDER COAT COLORS:



WHITE (WH)



YELLOW (YW)



## STANDARD GROUND SLEEVES



Allows for semi-permanent installation.

- 3 Year Limited Warranty

### 5¾" Post - Steel Post

FBSLV6 (PAIR)

### 4½" Post - Steel Post

FBSLV5 (PAIR)



## ACCESS FRAMES AND COVERS



For use with semi-permanent goals requiring removal from grass or turf fields.

- Aluminum, pressure-treated plywood, and artificial turf design
- 2 frames and 2 turf covered half plug plates included
- Optional full covers available
- 3 Year Limited Warranty



### Goals w/ Leveling Plate

18" x 18" x 6½" FBGPAF-1 (PAIR)



Optional full covers available



## SOCCER/ FOOTBALL ANCHOR KIT

(for SGP-600AX)



Fastens soccer goal rear crossbar to football goal gooseneck.

- 3 Year Limited Warranty

6¾" Post SFGA-6 (KIT)

5¾" Post SFGA-5 (KIT)

4½" Post SFGA-4 (KIT)

## FIELDPRO™ FOOTBALL NET SYSTEM



Keep field goals and extra point kicks away from spectators and inside the field. Easy-to-use pulley system raises/lowers net!

- (2) 6½" heavy-walled aluminum or 8½" heavy-walled steel uprights, (each upright is a 2-piece design) with ground sleeves
- Ground sleeve covers optional (FN-30-D)
- #36 knotted black nylon net with 3½" sq. mesh
- Pulley system and corrosion-resistant hardware included
- 3 Year Limited Warranty: System

Standard upright color is black. Custom colors available upon request for additional charge. Freight quote required.

<b>30'H x 40'W - 6½" aluminum</b>	FNFB-30 (EACH)
<b>30'H x 50'W - 6½" aluminum</b>	FNFB-3050 (EACH)
<b>40'H x 40'W - 6½" aluminum</b>	FNFB-40 (EACH)
<b>40'H x 60'W - 8½" steel</b>	FNFB-4060 (EACH)
<b>50'H x 50'W - 8½" steel</b>	FNFB-5050 (EACH)
<b>50'H x 60'W - 8½" steel</b>	FNFB-5060 (EACH)



## STATIONARY CEILING SUSPENDED FOOTBALL GOAL POST



Lightweight aluminum goal suspends directly beneath building structure. Great solution for indoor practice facilities!

- 6½" crossbar is official collegiate size at 18'6" wide
- 4" uprights available in 20' (1-piece design) or 30' (2-piece design) heights
- Crossbar leveling feature and suspension hardware included
- 5 Year Limited Warranty on post

White or Yellow powder coat options. Specify post color when ordering. Call for freight quote.

<b>30' Uprights</b>	CSGP-1XX
<b>20' Uprights</b>	CSGP-3XX

**POWDER COAT COLORS:**



## RETRACTABLE MOTORIZED CEILING SUSPENDED FOOTBALL GOAL POST



Lightweight aluminum goal suspends directly beneath building structure and lowers/raises via 1 HP electric hoist system. Great solution for indoor practice facilities!

- 6½" crossbar is official collegiate size at 18'6" wide
- 4" uprights available in 20' (1-piece design) or 30' (2-piece design) heights
- Crossbar leveling feature and suspension hardware included
- 5 Year Limited Warranty on post

White or Yellow powder coat options. Specify post color when ordering. Call for freight quote.

<b>30' Uprights</b>	CSGP-2XX
<b>20' Uprights</b>	CSGP-4XX

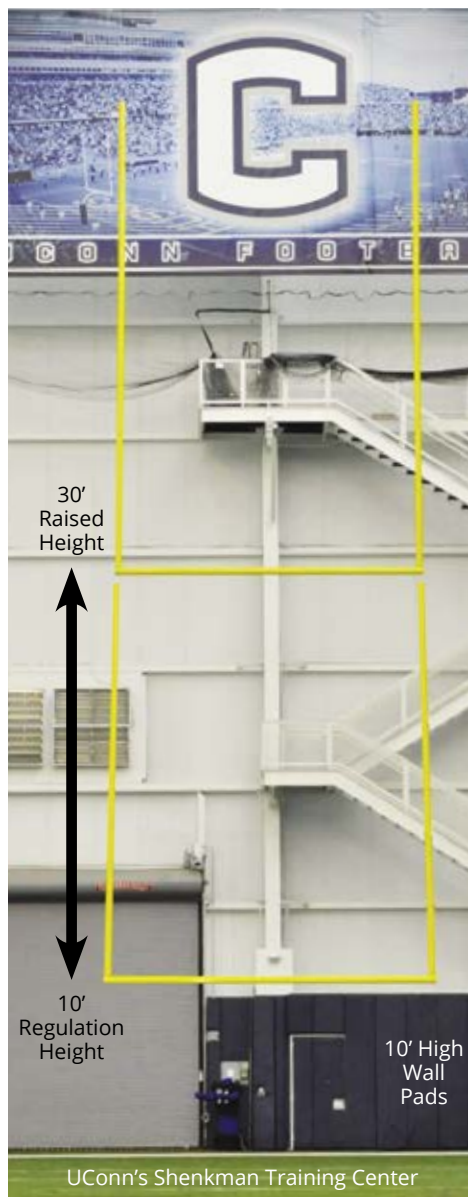





### PRO GOAL POST PADS



- 6' tall pad with minimum of 6" thick cylindrical high-density foam
- 17½" diameter
- 14 oz. nylon reinforced vinyl cover (available in 14 colors) with hook-and-loop closure
- 1 Year Limited Warranty

*Specify pad color when ordering.*

<b>6⅝" Post</b>	PPP-800 (PAIR)
<b>5⅑/16" Post</b>	PPP-700 (PAIR)
<b>4½" Post</b>	PPP-500 (PAIR)

### GOAL POST PADS



- 6' tall pad with minimum of 3¾" thick cylindrical protective safety foam
- 13" diameter
- 14 oz. nylon reinforced vinyl cover (available in 14 colors) with hook-and-loop closure
- 1 Year Limited Warranty

*Specify pad color when ordering.*

<b>5⅑/16" Post</b>	PPP-300 (PAIR)
<b>4½" Post</b>	PPP-100 (PAIR)

**VINYL PAD COLORS:**



## GRAPHICS FOR GOAL POST PADS



### GOAL POST PAD DIGITAL GRAPHICS

Customize your post padding. *Extended lead time.*

**Multi-color** JSG-FPP (PER PAD)



## FOOTBALL TRAINING

### SNAP ATTACK FOOTBALL MACHINE



- Releases passes and punts up to 100 yards
- 70+ yards for kick-offs
- 5-15 yards for snap tight spirals
- 70+ mph speeds
- 5 Year Limited Warranty

SAFM-1 (EACH)





### 8' CHAIN SET WITH FLIP DOWN INDICATOR PACKAGE



- 8' Chain Set; 2 Ten Yard Indicators with Chain (FCS-8)
- Flip Down Indicator (FFD-10)
- 1 Year Limited Warranty

FBCSPKG (PKG)



### CHAIN SET BAG

Holds flip indicator and 8' chain sets. 106"L x 18"H.

FBCSBAG (EACH)



### CHAIN SETS

Padded bright orange targets with plated chain and swivel hooks.

- 1 Year Limited Warranty

**8' High** FCS-8 (SET)

**7' High** FCS-7 (SET)



### FLIP DOWN INDICATOR

Completely padded indicator with durable flip down numbers.

- 1 Year Limited Warranty

FFD-10 (EACH)



### STANDARD SIDELINE MARKERS

- Solid polyfoam body, weighted base with red covers
- Large numerals (12" tall)
- Set of eleven includes one 50, and two each 40's, 30's, 20's, 10's and G's
- 1 Year Limited Warranty

**11 Piece Set**

FBWSM (SET)



### FOLDABLE SIDELINE MARKERS

- Self-standing markers with weighted bottoms and numerals on both sides
- Stores flat!
- Markers: 15"H x 15"W x 13"D
- Numbers: 13"H
- 1 Year Limited Warranty

**11 Piece Set**

FSM-11 (SET)



### FREE STANDING PYLONS

Self-standing end zone pylon with weighted bottom. Anchorless!

- 18"H x 4"W x 4"D
- 1 Year Limited Warranty

**4 piece**

FBPYLN (SET)



## STACKMASTER™ SHOULDER PAD RACK

- Stores up to 42 shoulder pads
- Steel frame with non-marking swivel wheels
- 76"H x 25"L x 22"W
- 3 Year Limited Warranty

SP-2 (EACH)

## STACKMASTER™ DELUXE SHOULDER PAD RACK



- Stores up to 60-80 shoulder pads
- Steel frame with non-marking swivel wheels
- Removable transport handle
- 70"H x 60"L x 24"W
- 3 Year Limited Warranty

SP4 (EACH)



## STACKMASTER™ HELMET RACK

- Stores up to 56 helmets
- Steel frame with non-marking swivel wheels
- 6'3"H x 2'6"W
- 3 Year Limited Warranty

H-1 (EACH)

## STACKMASTER™ DELUXE HELMET RACK



- Stores up to 60 helmets
- Steel frame with non-marking swivel wheels
- 64"H x 61"L x 24"W
- 3 Year Limited Warranty

FHC-1 (EACH)



## PROFESSIONAL PORTABLE KICKING CAGE

Heavy-duty kicking cage with knotless net contains balls for warm-up exercises.

- Galvanized steel frame
- Folds down for convenient storage
- Carry bag included
- 86"H x 48"W x 48"D
- 3 Year Limited Warranty: Cage

**Cage/Net** PKC-1 (EACH)

**Repl. Net** PKC-1N (EACH)



## PORTABLE KICKING CAGE

- 1½" frame with 26 lb. weighted base
- Durable slip-on net included
- 6'6"H x 48"W
- 3 Year Limited Warranty: Cage

PK-64 (EACH)





### LOWDOWN LINEMEN CHUTE



Heavy-duty chute for training linemen and backers to stay low. Great for running blocking schemes and trap drills.

- Steel frame on 12" pneumatic swivel wheels
- 42" to 66" height adjustment with telescopic legs

- Black mesh screen on lower frame is chain suspended and padded
- 3 Year Limited Warranty

**20'L x 6'W** FBLC-20 (EACH)

**30'L x 6'W** FBLC-30 (EACH)

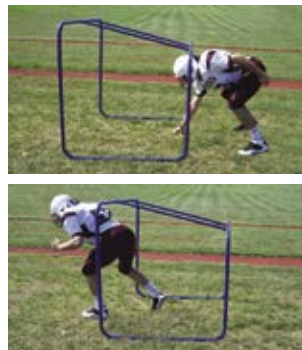

### LINEMEN CHUTE

Teach the basics of coming off the ball low and driving upward.

- Steel frame with pin-stop height adjustment
- Attach multiple chutes to replicate entire line
- 40"H to 50"H x 5'W x 4'L
- 3 Year Limited Warranty

FBLMCH (EACH)



### HIGH STEPPER AGILITY TRAINER

- Five adjustable heights to increase leg lift
- Steel tube frame with suspended 16 square rope grid
- Frame safely located outside running grid area
- 20'L x 6'W
- 3 Year Limited Warranty

FBHSTP (EACH)



Shown with cone pad

### SACKBACK TACKLE SLED



- Durable steel frame with 100 lb. impact-resistant foam
- 18 oz. vinyl cover
- Round, cone, and attack style models
- 1 Year Limited Warranty

*Specify vinyl color and model style when ordering. Call for freight quote.*

**Varsity Sled** TKSLDV (EACH)

**Pro Sled** TKSLDP (EACH)



FBST8



FBST12

### STEP OVER AGILITY DUMMY

- Dense foam core
- Double reinforced 18 oz. vinyl cover
- Back side handles for stand up practice
- 1 Year Limited Warranty

*Specify vinyl color when ordering.  
Call for freight quote.*

**48”L x 8”H x 17”W** FBST8 (EACH)  
**48”L x 12”H x 17”W** FBST12 (EACH)



### CURVED PRO BODY SHIELD

- Pre-curved 4” thick dense foam core
- Double reinforced 18 oz. vinyl cover
- Double web belt handles for sure grip
- 1 Year Limited Warranty

*Specify vinyl color when ordering.  
Call for freight quote.*

**24”L x 16”W x 4”D** FBPRCRV (EACH)



FBSUD38



FBSUD42



FBSUD48

### ROUND STAND-UP BLOCKING DUMMY

- Self-standing with dense foam core
- Double reinforced 18 oz. vinyl cover
- Double web belt handles for sure grip
- 1 Year Limited Warranty

*Specify vinyl color when ordering.  
Call for freight quote.*

**38”H x 14” diameter** FBSUD38 (EACH)  
**42”H x 14” diameter** FBSUD42 (EACH)  
**48”H x 14” diameter** FBSUD48 (EACH)

**VINYL PAD COLORS:**







### FIELD HOCKEY GOAL PACKAGE



Package Includes:

- (2) Official Field Hockey Goals (FHG-2ALS) with nets, bottom boards and wheels
- 5 Year Limited Warranty: Goal

**Goal** FHG-2ALPKG (PKG)



### OFFICIAL FIELD HOCKEY GOALS



Aluminum goals available with high-density bottom boards that never fade or break.

- All welded frames for maximum stability
- Net clips (SNT-180) included
- Wheel kit (FHG-1WKS) and net included
- 7'H x 12'W x 4'D
- 5 Year Limited Warranty: Goal

**Goal** FHG-2ALS (EACH)



### OFFICIAL BOTTOM BOARDS

Fits most field hockey goals. 18" high boards never fade or break!

- ½" thick high-density polyethylene
- Hardware included
- 3 Year Limited Warranty

FHG-16 (PAIR)



### WHEEL KIT

Optional tip-and-roll wheel kit for field hockey goals.

- 2 heavy-duty 10" no-flat tires
- Modifies 1 goal
- 3 Year Limited Warranty

FHG-1WKS (KIT)



### OFFICIAL FIELD HOCKEY NETS

- Weatherproof 1½" sq. mesh
- 2.5mm polyethylene material
- 7'H x 12'W x 4'D
- 1 Year Limited Warranty

FHND-8 (PAIR)



### PRACTICE FIELD HOCKEY GOAL



Official size practice goal with cast aluminum corners for easy assembly.

- 15/16" galvanized steel frame with black net (FNHD-8) included
- 7'H x 12'W x 4'D
- 3 Year Limited Warranty: Goal

PFHG-41 (EACH)

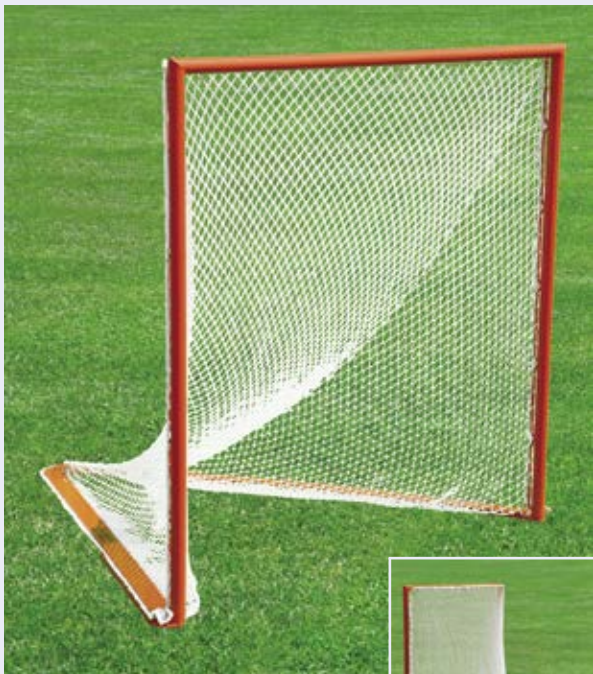

Lacrosse Goals

## PROFESSIONAL LACROSSE GOAL PACKAGE



Package Includes:

- (2) Professional Lacrosse Goals (LG-1XS)
- (2) Seamless Lacrosse Nets (NETX1-G260)
- FREE graphics on base plate (JSG-LAX)
- Lacrosse Goal Cart (LG-HT)
- 3 Year Limited Warranty: Goal

LG-1XPKG (PKG)



NETX1 Seamless Nets



Goal Cart



FREE Graphics



## PROFESSIONAL FIELD LACROSSE GOAL



Official size 3-piece goal with heavy weighted backstays are designed for professional or collegiate play.

- 2" heavy-walled steel frames with 4"W x 3/8"H base plates
- Net attaches to net rails and secured beneath cover plates
- Net (NETX1-G260 or NETX1-G160) included
- 6'H x 6'W x 80"D
- 3 Year Limited Warranty

Call 800-243-0533 for custom graphics quote to display logos and sponsors on cover plates.

**Goal & White Net** LG-1XS (EACH)

**Goal & Black Net** LG-1XSBK (EACH)



Display logos and sponsors on flat cover plate



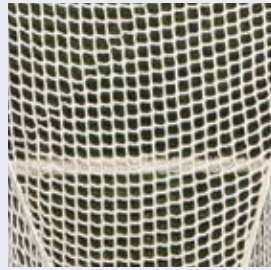

## OFFICIAL LACROSSE GOAL PACKAGE



Package Includes:

- 2 Official Lacrosse Goals (LG-50B)
- 2 Professional Lacrosse Nets (LGN-50)
- 3 Year Limited Warranty: Goal

LG-50PKG (PKG)



## OFFICIAL FIELD LACROSSE GOAL



Official size 5-piece goal for men's/women's leagues.

- 2" rust-proof zinc coated steel frame
- Full net rail on entire goal face
- Net (LGN-50) included
- 6'H x 6'W x 80"D
- 3 Year Limited Warranty

LG-50B (EACH)



Net pocket slides under backstay for secure fit

## PRACTICE FIELD LACROSSE GOAL

Official size goal for home or practice fields.

- 1¾" steel frame
- 3.5mm net included w/lacing cord
- 6'H x 6'W x 80"D
- 3 Year Limited Warranty

LG-540 (EACH)



## BOX LACROSSE GOAL PACKAGE

Package Includes:

- 2 Box Lacrosse Goals (LG-44B)
- 2 Box Lacrosse Nets (LGN-44)
- 3 Year Limited Warranty: Goal

LG-44BPKG (PKG)



## OFFICIAL BOX LACROSSE GOAL

Official size goal for all levels of indoor lacrosse under Professional play.

- 2" rust-proof zinc coated steel frame
- Full net rail on entire goal face
- 4mm knotless net with 1½" sq. mesh w/lacing cord
- 4'H x 4'W x 4'D
- 3 Year Limited Warranty

LG-44B (EACH)



## LACROSSE GOAL CART

Easily transports lacrosse goals up to 6'8" wide.

- Heavy-duty steel frame with black powder coat finish
- 10" tires - natural and artificial turf friendly
- 3 Year Limited Warranty

LG-HT (EACH)





### LACROSSE REBOUNDER

Durable steel frame rebounder with adjustable target angle for shot and passing practice.

- Target Area - 4'H x 3'W
- Frame - 8'H x 4'W
- 3 Year Limited Warranty

LAX-RBD (EACH)



### LACROSSE TRAINING NET

Improve shooting accuracy with this training net.

- Fits any 6' x 6' goal
- Carry bag included
- 1 Year Limited Warranty

LAX-TN (EACH)



### LACROSSE CREASE

Mark where attackers/midfielders should be prior to firing a shot on goal. Carry bag and ground stakes included.

- 1 Year Limited Warranty

LAX-C (EACH)



### FIELD ID MARKER

14" sq. vinyl marker with corner grommets to number goals. Net attachments not included.

*Specify numbers when ordering*

- 1 Year Limited Warranty

FIM-14 (EACH)

#### VINYL COLORS:

*Specify vinyl color when ordering*



### PORTABLE FIELDPRO™ NET SYSTEM

Lightweight indoor/outdoor portable net system for fields and courts where in-ground/sleeve systems are not an option. Can also be used as a multi-field/court space divider!

*See (page 175) for details.*



### FIELDPRO™ MULTI-SPORT NET SYSTEM

Ball stop net system for lacrosse, field hockey, and other field sports. Ensure the safety of athletes, coaches, and spectators. Easy-to-use pulley system raises/lowers net!

*See (pages 172-174) for details.*

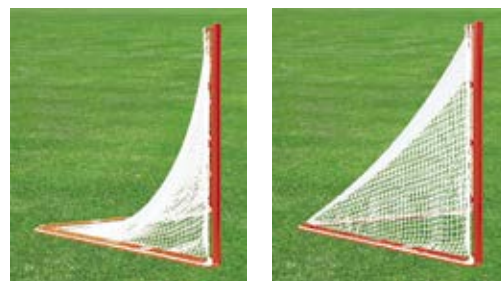

“Body fit” rope to adjust net slack/tension



Robust and long lasting in either white or black

## SEAMLESS ONE-PIECE LACROSSE NET



The NETX1™ lacrosse net is the most robust and long-lasting net money can buy. Its one-piece design eliminates the most common points of failure on traditional lacrosse nets: the diagonal seams, while providing a modern aesthetic that truly sets it apart.

The UV/weather stabilized “double-needle” nylon twine has a true 7mm thickness (measured across the depth and width of the twine) with a minimum breaking strength of 770 lbs. The combination of high strength twine and lack of diagonal seams means it will outlast every other net on the market.

The included “body fit” rope adjusts the net on the goal to maintain an appropriate amount of slack so balls remain inside the goal without bouncing back out.

- Weather-stabilized 7mm x 1½” sq. knotless nylon with breaking strength of 770 lbs.
- One-piece design eliminates diagonal seams (the most common point of failure)
- Lacing cord included
- 1 Year Limited Warranty

Goal Type	Size	Color	Item #	UoM
<b>Box</b>	4'H x 4'W x 4'D	White	NETX1-D260	(EACH)
<b>Field</b>	6'H x 6'W x 7'D	Black	NETX1-G160	(EACH)
<b>Field</b>	6'H x 6'W x 7'D	White	NETX1-G260	(EACH)

Proudly used by Yale University in New Haven, CT - A Division 1 Lacrosse Program





# OFFICIAL LACROSSE NETS

6'H x 6'W x 7'D

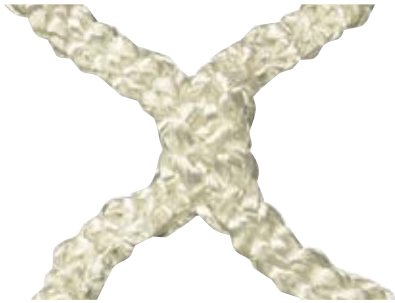

## OFFICIAL 5MM LACROSSE NET



- 5mm knotless white net with 1½" sq. mesh
- Weatherproof polyester
- Lacing cord included
- 6'H x 6'W x 7'D
- 1 Year Limited Warranty

LGN-50 (EACH)



## OFFICIAL 4MM LACROSSE NET



- 4mm knotless white net with 1½" sq. mesh
- Weatherproof polyester
- Lacing cord included
- 6'H x 6'W x 7'D
- 1 Year Limited Warranty

LGN-30 (EACH)



## PRACTICE 3.5MM LACROSSE NET

- Official size
- 3.5mm knotless net with 1½" sq. mesh
- Lacing cord included
- 6'H x 6'W x 7'D
- 1 Year Limited Warranty

LGN-25 (EACH)

# BOX LACROSSE NETS

4'H x 4'W x 4'D

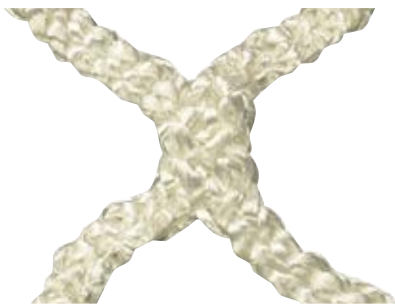

## BOX LACROSSE NET 6MM

- 6mm knotless white net with 1½" sq. mesh
- Lacing cord included
- Replacement net for (LG-44B)
- 4'H x 4'W x 4'D
- 1 Year Limited Warranty

LGN-44X (EACH)



## BOX LACROSSE NET 4MM

- 4mm knotless white net with 1½" sq. mesh
- Lacing cord included
- Replacement net for (LG-44B)
- 4'H x 4'W x 4'D
- 1 Year Limited Warranty

LGN-44 (EACH)

Official Field Lacrosse Goal

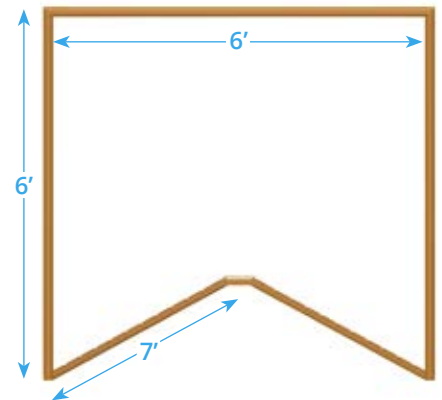

Official Box Lacrosse Goal

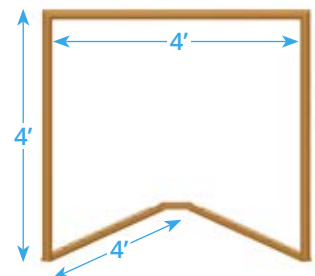

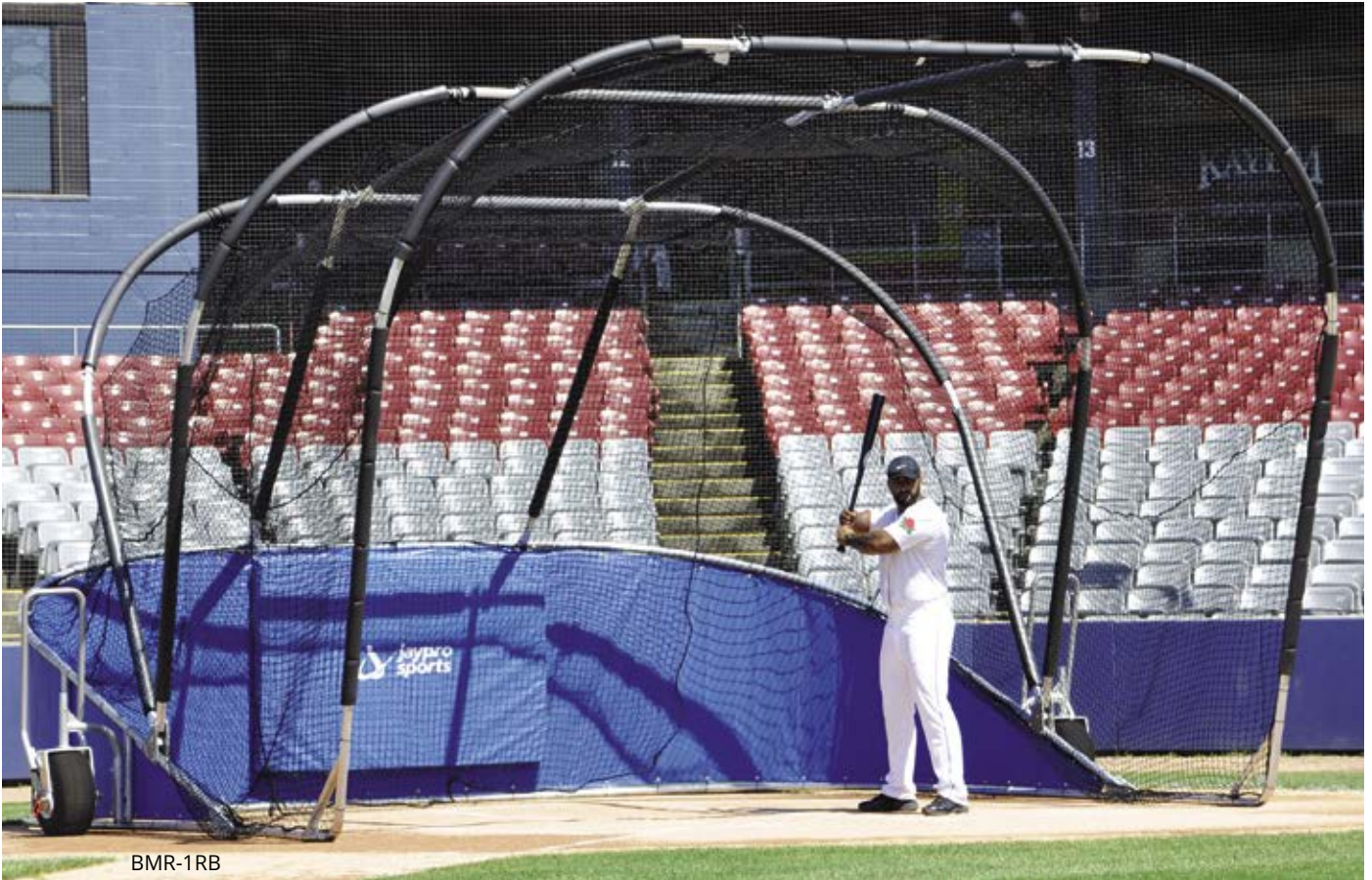

BMR-1RB

## BUY A BETTER CAGE!



(1)

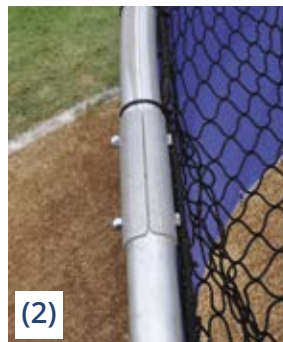

(2)



(3)



(4)

### Jaypro's swivel wheel allows for a more precise cage placement!

- (1) The addition of handle wheels controls the cage height over uneven surfaces, which allows for additional leverage to lift and raise the cage. Reduces cage drag and divots while in motion.
  - (2) Includes joint reinforcing clamps for added rigidity
  - (3) Through-bolts and locking nut connections only, no allen screws here!
  - (4) 18"W x 9"D swivel tires can be adjusted to two different heights which allow movement in multiple directions for easy installation and removal on the playing field
- Fully welded design and pre-assembled side frames make the cage strong and rigid for a long life span
  - Net attaches directly to the frame and has reinforced seams and an integrated baffle



# BOMBER ALL-STAR



Heavy-duty portable batting cage with swivel side wheels and handles allows for easy transportation or movement on and off the field.

- 2" heavy-wall aluminum tube design
- #42 weather-treated nylon net with rear net baffle
- Thud pad, 18 oz. vinyl skirt, oversized swivel tires with handles, and black ricochet padding on frame w/ dual observation platforms
- Open Inside Dimensions - 12'H x 18'W x 22'D
- Folded Outside Dimensions - 6'H x 20'W x 15'D
- Thud Pad - 4'H x 6'W x 4"D
- 7 Year Limited Warranty

See (page 77) for replacement parts pertaining to the Bomber All-Star cage.

<b>Royal Blue</b>	BMR-1RB (EACH)
<b>Black</b>	BMR-1BK (EACH)
<b>Red</b>	BMR-1RD (EACH)
<b>Green</b>	BMR-1GR (EACH)
<b>Navy Blue</b>	BMR-1NB (EACH)
<b>Maroon</b>	BMR-1MR (EACH)

## GRAPHIC PANEL

Call 800-243-0533 for product details.

SKT-DROP (EACH)

### SKIRT & PAD COLORS:



Royal Blue



Black



Red



Green



Navy Blue

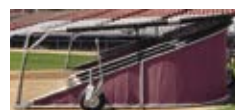

Maroon



BMR-1RB shown with ricochet padding upgrade kit (RPAD-UKITRB)



## RICOCHEP PADDING UPGRADE KIT



- Hook-and-loop vinyl attachment that wraps around foam padding
- Kit contains (21) 6 foot lengths
- 1 Year Limited Warranty

Specify vinyl color when ordering.

RPAD-UKITXX (EACH)



Easily bring down the Cage to get ready for Transport



Strong Struts won't slip



Rear Wheel & Dual Coaches Stand



Swivel Tires with Handles



Folds Down to 6' High



Thud Pad and Rear Net Baffle



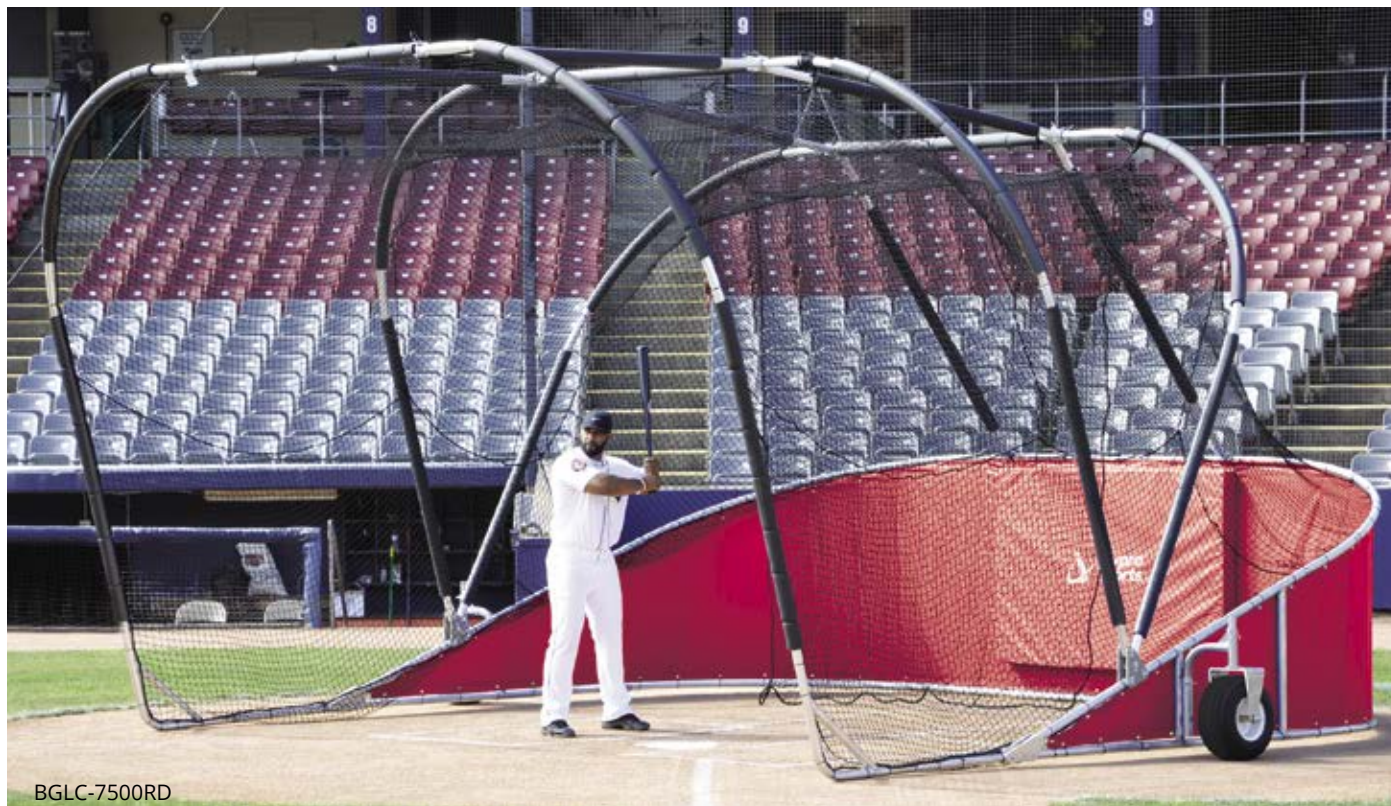

BGLC-7500RD

# BOMBER ELITE









Heavy-duty portable batting cage with side wheels that can be rotated and pinned 90°. Two height settings for added clearance during transport.

- 2" heavy-wall aluminum tube design with fully welded side frames
- #42 weather-treated nylon net with rear net baffle
- Thud pad, 18 oz. vinyl skirt, and black ricochet padding on frame with dual observation platforms
- Open Inside Dimensions - 12'H x 18'W x 22'D
- Folded Outside Dimensions - 6'H x 20'W x 15'D
- Thud Pad - 4'H x 6'W x 4"D
- 7 Year Limited Warranty

See (page 77) for replacement parts pertaining to the Bomber Elite cage.

<b>Royal Blue</b>	BGLC-7500RB (EACH)
<b>Black</b>	BGLC-7500BK (EACH)
<b>Red</b>	BGLC-7500RD (EACH)
<b>Green</b>	BGLC-7500GR (EACH)
<b>Navy Blue</b>	BGLC-7500NB (EACH)
<b>Maroon</b>	BGLC-7500MR (EACH)

### SKIRT & PAD COLORS:

-  ROYAL BLUE
-  BLACK
-  RED
-  GREEN
-  NAVY BLUE
-  MAROON



18"W x 9"D Oversized Turf-Friendly Tires



Strut Storage and Dual Coaches Stand

### RICOCHET PADDING

#### UPGRADE KIT (See page 75)

- Hook-and-loop attachment that wraps around foam padding
- Kit contains (21) 6 foot lengths
- 1 Year Limited Warranty

Specify padding color when ordering.

RPAD-UKITXX (EACH)

### GRAPHIC PANEL

Call 800-243-0533 for product details.

SKT-DROP (EACH)





# BIG LEAGUE SERIES



BBGS-18GR

## BOMBER PRO









Heavy-duty portable batting cage for spring training camps, semi-professional, and collegiate use.

- 2" heavy wall aluminum tube design
- #42 weather-treated nylon net with rear net baffle
- 18 oz. vinyl skirt, oversized pneumatic tires, and black ricochet padding on frame
- Open Inside Dimensions - 12'H x 18'W x 22'D
- Folded Outside Dimensions - 6'H x 20'W x 15'D
- 5 Year Limited Warranty

*Specify skirt colors when ordering.*

<b>Royal Blue</b>	BBGS-18RB (EACH)
<b>Black</b>	BBGS-18BK (EACH)
<b>Red</b>	BBGS-18RD (EACH)
<b>Green</b>	BBGS-18GR (EACH)
<b>Navy Blue</b>	BBGS-18NB (EACH)
<b>Maroon</b>	BBGS-18MR (EACH)

### SKIRT & PAD COLORS:

-  ROYAL BLUE
-  BLACK
-  RED
-  GREEN
-  NAVY BLUE
-  MAROON

### REPLACEMENT PARTS

*Specify skirt and thud pad color when ordering.*

<b>Skirt</b>	SKT-75XX (EACH)
<b>Replacement Net</b>	BLN-3 (EACH)
<b>Thud Pad</b>	THUD-46XX (EACH)
<b>Viewing Stand</b>	CVS-10 (EACH)
<b>Struts (Set of 6)</b>	BGLC-75STRUTS (SET)
<b>Ricochet Cushion (6'L - Black)</b>	BPD-6 (EACH)
<b>Weather Resistant Tape (60 yd roll)</b>	PDT-3 (EACH)

### GRAPHIC PANEL

*Call 800-243-0533 for product details.*  
SKT-DROP (EACH)



Folds Down to 6' High



Strut Storage



Oversized Tires





BBLS-12

# BOMBER



Heavy-duty portable batting cage for high school and youth programs.

- 2" heavy-wall aluminum tube design
- #42 weather-treated nylon net with rear net baffle
- Heavy-duty tires and black ricochet cushion on frame
- Folds down for convenient storage
- Optional vinyl skirt (SKT-20XX) sold separately
- 12'H x 17' 6"W x 12'D
- 5 Year Limited Warranty

### OPTIONAL SKIRT COLORS:



Royal Blue (RB)

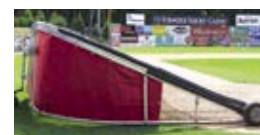

Red (RD)



Green (GR)



Navy Blue (NB)

**Cage** BBLS-12 (EACH)

## REPLACEMENT PARTS

- 1 Year Limited Warranty
- Specify skirt color when ordering.*

**Skirt** SKT-20XX (EACH)  
**Viewing Stand** CVS-10 (EACH)  
**Replacement Net** LSN-2 (EACH)  
**Ricochet Cushion** BPD-6 (EACH)



BBLS-12 with green skirt





## LINE DRIVE CAGE



Portable and foldable batting cage for high school.

- 5 Year Limited Warranty

**Cage** BBLD-5000 (EACH)

## LINE DRIVE

Portable and foldable batting cage for high school.

- 2" flo-coated galvanized steel
- #42 knotless nylon weather-treated net with rear net baffle
- 16" pneumatic wheels
- Rear tire swivels for easy mobility
- Folds down to 48"H for convenient storage
- Open: 11' 8"H x 18' 6"W x 19' 3"D
- Folded: 48"H x 18' 6"W x 16' 9"D

## LINE DRIVE CAGE NET



Replacement net for the Line Drive Batting Cage.

- 12'H x 16' 6"W x 16' 6"D
- 1 Year Limited Warranty

**Net** LDN-5 (EACH)

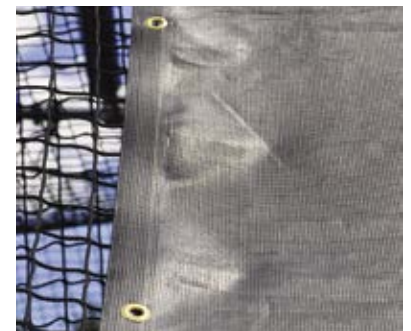

## BATTING CAGE SUN CANOPY

- 25' 6"L x 6'W with hemmed perimeter and grommets
- Made from 8.2 oz./sq. yd. PVC coated polyester wind screen
- Lacing and ties included for attachment
- 1 Year Limited Warranty

*Call for freight quote.*

BBBCSC (EACH)



MPCTF-55S

## MEGA OUTDOOR BATTING TUNNEL FRAMES



Clean frame design with less structure for balls to ricochet off. Easily slide net to one end for storage or remove snap hooks to pack net away during the off-season!

- 8" steel pole design with black powder coat finish
- Net attaches to tensioned galvanized aircraft cable
- Single tunnel and double tunnel models (permanent installation)
- #36 black knotted nylon net with 1¾" sq. mesh included
- 3 Year Limited Warranty

<b>Single 55'</b>	MPCTF-55S (EACH)
<b>Single 70'</b>	MPCTF-70S (EACH)
<b>Double 55'</b>	MPCTF-55D (EACH)
<b>Double 70'</b>	MPCTF-70D (EACH)

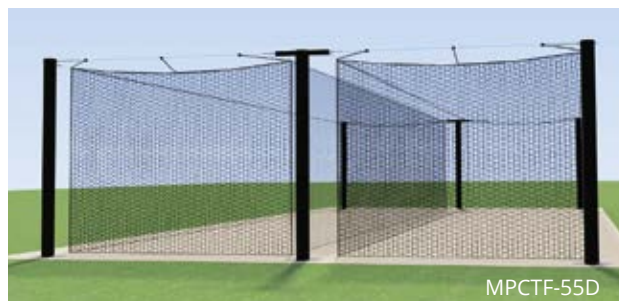

MPCTF-55D



## MEGA STACKABLE TUNNEL KITS

Stack multiple tunnels (MPCTF-55S or MPCTF-70S) side by side.

- (2) center posts
- Cable and attachment hardware included
- (1) #36 black knotted nylon net with 1¾" sq. mesh included

<b>55' Cage</b>	MPCTF-55A (EACH)
<b>70' Cage</b>	MPCTF-70A (EACH)





PROTF-70

Pitchers Screen (PS-84)  
sold separately

## PROFESSIONAL OUTDOOR BATTING TUNNEL FRAMES



Clean frame design with less structure for balls to ricochet off. Individual hoist lines make for easy installation/removal of net!

- 4" curved aluminum tubing provide 2' offset
- Single tunnel and double tunnel models (permanent installation)
- Ground sleeves included
- Recommended net (BBCP-7014 or BBCP-5514) sold separately
- 3 Year Limited Warranty

*Design compatible with both 12' and 14' wide tunnel nets.*

<b>Single 55'</b>	PROTF-55 (EACH)
<b>Single 70'</b>	PROTF-70 (EACH)
<b>Double 55'</b>	PROTF-55T (EACH)
<b>Double 70'</b>	PROTF-70T (EACH)



PROTF-70T

## PROFESSIONAL STACKABLE TUNNEL KITS

Stack multiple tunnels (PROTF-55 or PROTF-70) side by side.

- (4) center posts for 55' or (5) center posts for 70' tunnel
- Cable and attachment hardware
- (1) net (BBCP-5514 or BBCP-7014) sold separately



<b>55' Cage</b>	PROTF-55A (EACH)
<b>70' Cage</b>	PROTF-70A (EACH)





### SEMI-PERMANENT OUTDOOR BATTING TUNNEL FRAMES



- 2" galvanized steel tubing design
- Net hangs on 3 rows of galvanized aircraft cable
- Ground sleeves included
- Tunnel nets sold separately
- 3 Year Limited Warranty

*Design compatible with both 12' and 14' wide tunnel nets.*

**70'L x 12'H - 5 Wickets** BBTF-70 (EACH)

**55'L x 12'H - 4 Wickets** BBTF-55 (EACH)

### SURFACE-MOUNTED OUTDOOR BATTING TUNNEL FRAMES



Same features as the Semi-Permanent Frame except NO ground sleeves.

- 6" sq. surface-mount plates included

*Design compatible with both 12' and 14' wide tunnel nets.*

**70'L x 12'H - 5 Wickets** BBTFSM-70 (EACH)

**55'L x 12'H - 4 Wickets** BBTFSM-55 (EACH)



### WEIGHTED TUNNEL SAND TUBES



Keep batting tunnel nets from blowing around. Add sand easily with zippered opening!

- 18 oz. black vinyl tube (sand not included)
- 5 net attachment clips included
- 60"L x 5"W
- 3 Year Limited Warranty

*14 sand tubes recommended for a 70'L x 12'W batting tunnel.*

SWB-TUBE (EACH)



### CAGE SAVER TARGET

Heavy-duty reinforced vinyl tarp w/ strike zone.

- Grommets and hanging straps included
- 6'H x 5'W
- 1 Year Limited Warranty

CST65 (EACH)



# BATTING TUNNEL NETS

Durable black nylon and polyethylene tunnel nets are weather-resistant and UV protected.



## ALL-STAR SERIES TUNNEL NYLON NETS



- #36 thread count
- Twisted knotted nylon net with 1¾" sq. mesh
- ¾" twisted poly rope borders
- 1 Year Limited Warranty

<b>70'L x 14'W x 12'H</b>	BBC36-7014 (EACH)
<b>70'L x 12'W x 12'H</b>	BBC36-7012 (EACH)
<b>55'L x 14'W x 12'H</b>	BBC36-5514 (EACH)
<b>55'L x 12'W x 12'H</b>	BBC36-5512 (EACH)

## PRO CLIMATIZED TUNNEL NETS



- #42 thread count and high abrasion-resistant
- 2.5mm twisted knot polyethylene fiber net with 1¾" sq. mesh
- Roped perimeters and corners
- 1 Year Limited Warranty



<b>70'L x 14'W x 12'H</b>	BBCP-7014 (EACH)
<b>70'L x 12'W x 12'H</b>	BBCP-7012 (EACH)
<b>55'L x 14'W x 12'H</b>	BBCP-5514 (EACH)
<b>55'L x 12'W x 12'H</b>	BBCP-5512 (EACH)



## BATTING MAT

See (page 86) for product details.

<b>Green Turf</b>	BML612G (EACH)
<b>Red Clay</b>	BML612CL (EACH)

## COLLEGIATE CLIMATIZED TUNNEL NETS



- #24 thread count
- 2mm polyethylene fiber with 1¾" sq. mesh
- Roped perimeters and corners
- 1 Year Limited Warranty

<b>70'L x 14'W x 12'H</b>	BBCC-7014 (EACH)
<b>70'L x 12'W x 12'H</b>	BBCC-7012 (EACH)

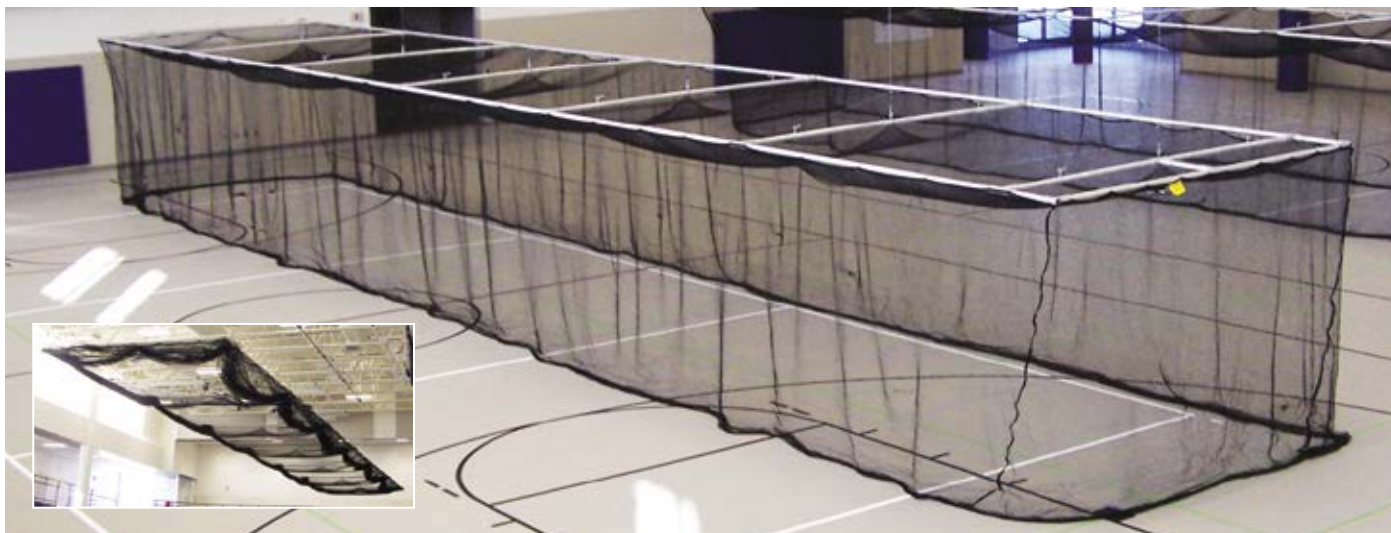

### CEILING SUSPENDED RETRACTABLE BATTING CAGES



Robust indoor batting cage is raised/lowered from ceiling by an electric winch controlled drive shaft.

- 2" heavy-walled aluminum tubing design
- Tunnel net (BBC36-7012 Baseball) or (BBC-700N Multi-Sport) included
- Ceiling mounting kit sold separately
- 70'L x 12'W x 11'H
- 3 Year Limited Warranty on cage

14' wide cages and custom sizes available. Call for quote.

**Baseball - 1¾" mesh**      BBC-700B (EACH)  
**Multi Sport - ¾" mesh**      BBC-700M (EACH)

### INDOOR MULTI-SPORT TUNNEL NET



- Knotless nylon net with ¾" sq. mesh
- Black net is UV stabilized
- 70'L x 12'W x 12'H
- 1 Year Limited Warranty

Custom sizes available. Call for quote.

BBC-700N (EACH)

See (page 83) for Baseball Tunnel Net options.



Wall Mounting Kit shown (optional)

### QUICK SET-UP INDOOR BATTING CAGE



Full-size batting cage attaches wall to wall by tension system. No cables or structure left behind when not in use. Sets up in minutes without a ladder!

- Marine grade rigging blocks with locking cams to both tension and lock net in position
- 120' max wall spacing for both cages
- 63' minimum wall spacing for 55'L cage and 85' minimum wall space for 70'L cage
- Wall Mounting Kit (BBC-WLKT) available if mounting to concrete or block walls
- 1 Year Limited Warranty

Includes hardware for attachment to most building structures. Custom sizes available upon request.

**70'L x 14'W x 14'H**      BBC-QS70 (EACH)  
**55'L x 14'W x 14'H**      BBC-QS55 (EACH)



### PERPENDICULAR CEILING MOUNTING KIT



Spanning Perpendicular Not Greater Than 8' on Center: For cages oriented perpendicular to beams or bar joists spaced no greater than 8' apart.

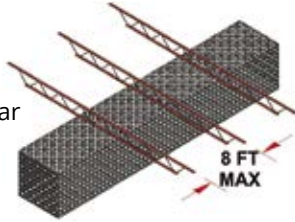

BBC-PERPKITA (EACH)

### PERPENDICULAR CEILING MOUNTING KIT



Spanning Perpendicular 8'-12' on Center: For cages oriented perpendicular to beams or bar joists spaced greater than 8' but not over 12' apart.

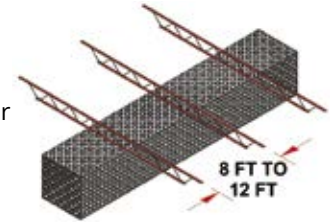

BBC-PERPKITB (EACH)

### RIGID FRAME CEILING MOUNTING KIT



- Peaked or Rigid Frame Building (call for pricing)
- For cages being placed in a peaked rigid frame building
- Drive supports to be chained down from roof purlins with rigid winch support

BBC-RIGKIT (EACH)

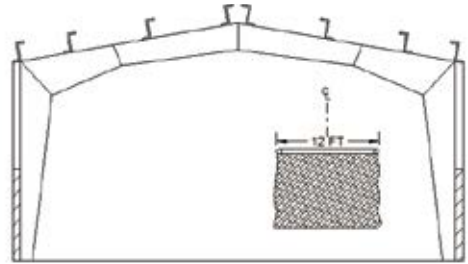

### CABLE SUSPENDED TUNNEL KIT



- Net suspended on aircraft cable every 3' on center
- Support cables can be placed higher in ceiling (up to 30')
- Overhead space maximized when net is stored in position
- Net and attachments sold separately

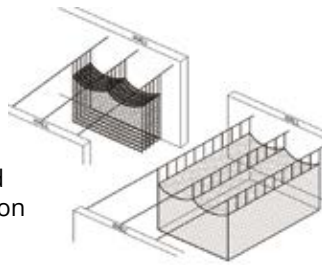

BBC-SPDKT (EACH)

### CABLE SUPPORTED TUNNEL KIT



- Net attaches to cables running wall to wall
- Easily slides against wall for storage
- (3) 100' rolls of aircraft cable and hardware included
- Net and attachments sold separately

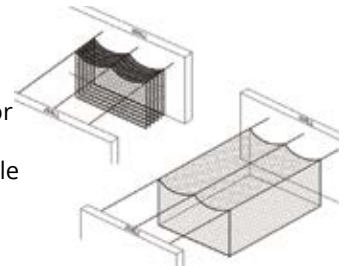

BBC-SPRTKT (EACH)

### WALL MOUNTING KIT



- Attaches to concrete, block, or steel framed walls
- 6 finished wood pads and steel mounting plates included
- Wall anchors supplied by installer based on wall specifications

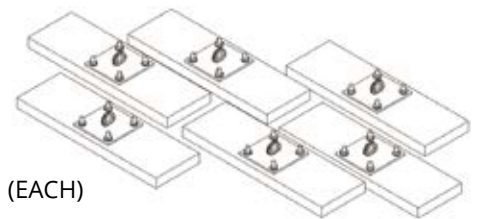

BBC-WLKT (EACH)

### PARALLEL CEILING MOUNTING KIT



Direct Attached: For cages centered directly beneath a beam or bar joist (system attaches directly to single beam or bar joist).

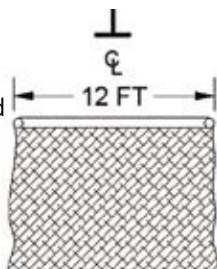

BBC-UBKIT (EACH)

### PARALLEL CEILING MOUNTING KIT



Spanning Parallel 8' on Center or Less: For cages with a centerline located between two beams or bar joists spaced 8' apart or less.



BBC-PARKITA (EACH)

### PARALLEL CEILING MOUNTING KIT



Spanning Parallel 8'-12' on Center: For cages with a centerline located between two beams or bar joists spaced greater than 8' but not over 12' apart.

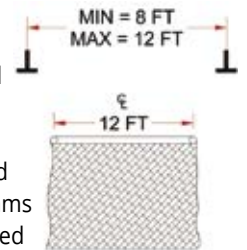

BBC-PARKITB (EACH)

TURF34



TURF34P



## BATTING TUNNEL TURF



Ideal for batting cage floors, dugouts, baselines, bullpens, coach boxes, walkways and more.

- All turf is green and sold by the square foot, in rolls
- Excess turf may be trimmed in the field
- 3 Year Limited Warranty

Call for freight quote.

## 34 OZ. POLY TURF

**12'W - Unitary Backing**

TURF34 (SQ FT)

**12'W - 5mm Pad Backing**

TURF34P (SQ FT)

## 30 OZ. NYLON TURF

**15'W - Unitary Backing**

TURF30 (SQ FT)

**12' or 15'W - 5mm Pad Backing**

TURF30P (SQ FT)



## BATTING MAT



- Indoor/outdoor use
- Spike-resistant artificial turf with throw down home plate
- Inlaid white lines and thick foam backing
- 6'L x 12'W
- 3 Year Limited Warranty

Call for freight quote.

**Green Turf** BML612G (EACH)

**Red Clay** BML612CL (EACH)



## WEIGHTED TUNNEL SAND TUBES



Keep batting tunnel nets from blowing around. Add sand easily with zippered opening!

- 18 oz. black vinyl tube (sand not included)
- 5 net attachment clips included
- 60"L x 5"W
- 3 Year Limited Warranty

14 sand tubes recommended for a 70'L x 12'W batting tunnel.

SWB-TUBE (EACH)



HABPM-100



HABPM-100JR

## HACK ATTACK PITCHING MACHINES



3 wheel advantage design provides accuracy and speed with no wear. Emulates a live pitcher with speeds of 35-100 mph (35-70 mph - high school junior machine) and a distance of 43'. Fastballs, risers, drops, right and left handed screwballs, pop-ups, fly balls, and grounders. 5 Year Limited Warranty.

**Baseball** HABPM-100 (EACH)

**Softball** HASPM-200 (EACH)

**Baseball Junior** HABPM-100JR (EACH)

**Softball Junior** HASPM-200JR (EACH)



## PERMANENT BASEBALL/ SOFTBALL BACKSTOPS



Galvanized steel backstops with overhang section and durable fence fabric.

- 10'W x 12'H upright sections and 10'W x 6'D overhang section
- 2 $\frac{3}{8}$ " main uprights and 1 $\frac{1}{2}$ " crossbars
- 9 gauge smooth galvanized fence fabric
- All galvanized fittings, nuts, and bolts included
- 3 Year Limited Warranty

*Backstop sections are not prefabricated chain link. Call for freight quote.*



### 3 Panel Design

Item #	Description	UoM
BSP-30	3 Panels only	(EACH)
BSP-30-6	3 Panels, 1 Center Overhang	(EACH)
BSP-33-2	3 Panels, 1 Center, 2 Wing Overhangs	(EACH)

### 4 Panel Design

Item #	Description	UoM
BSP-40	4 Panels only	(EACH)
BSP-40-66	4 Panels, 2 Center Overhangs	(EACH)
BSP-44-22	4 Panels, 2 Center, 2 Wing Overhangs	(EACH)

## BASEBALL/SOFTBALL TENSIONED BACKSTOP NET SYSTEMS



Safety tensioned backstop netting designed to not only stop the ball, but minimize net deflection. Two basic systems are available.

### Tensioned Pole to Pole Backstop Net System

**BTPNS** Engineered structural poles support tensioned netting with fewer poles.

### Tensioned Cable Backstop Net System

**BPCNS** Pull-back cables attached to building structure or offset pull-back poles, for a cleaner look with reduced obstructions.

Features:

- Designed to meet your specific field/facility needs
- Engineered structural poles with heights up to 40 ft.
- In-ground and surface mount pole installations available
- Systems can be free-standing or incorporated into backstop knee-wall
- Netting Options:
  - #36 knotted nylon, 1 $\frac{3}{4}$ " black sq. mesh netting
  - 1 $\frac{3}{4}$ " black knotted Dyneema (UHMWPE) sq. mesh netting, for unsurpassed strength and visibility
- Poles are powder coated black over zinc rich primer
- All hardware is galvanized
- 3 Year Limited Warranty

*Call 800-243-0533 for more information and design assistance. Call for freight quote.*



# PROFESSIONAL FOUL POLES

Baseball and softball foul poles designed to optimize air passage and engineered to withstand up to 130 mph winds! Perm/Semi-Perm and Surface Mount installation available!

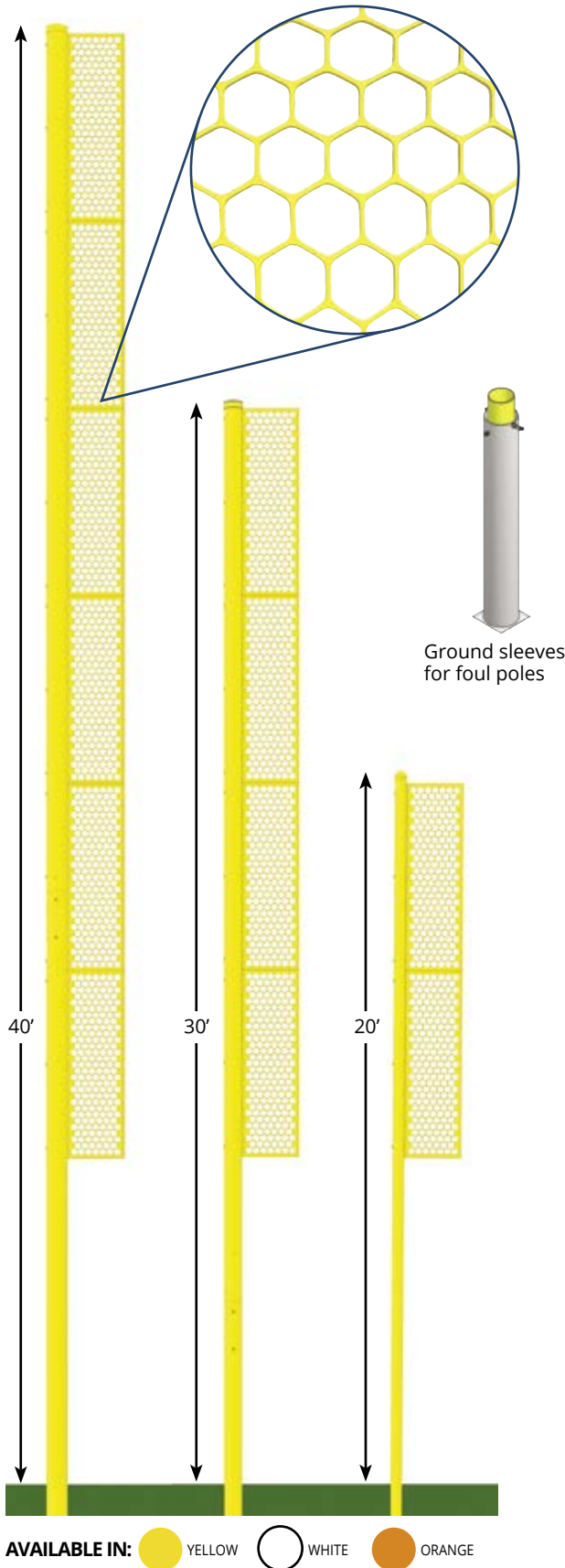

## 20' PROFESSIONAL FOUL POLE

- Main upright is 3½" OD Sch 40 zinc coated steel (1 piece)
- (2) 5'H x 18"W x 2"D bolt-on wing panels made of 11 gauge perforated steel
- 3 Year Limited Warranty

Perm/Semi-Perm	<b>Yellow</b>	BBFP-20 (PAIR)
Perm/Semi-Perm	<b>White</b>	SBFP-200-WT (PAIR)
Perm/Semi-Perm	<b>Orange</b>	SBFP-200-OR (PAIR)
Surface Mount	<b>Yellow</b>	BBFP-20SM (PAIR)
Surface Mount	<b>White</b>	SBFP-200SM-WT (PAIR)
Surface Mount	<b>Orange</b>	SBFP-200SM-OR (PAIR)

**20' Ground Sleeves** FPS-20 (PAIR)

## 30' PROFESSIONAL FOUL POLE

- Main upright is 5½" OD Sch 40 zinc coated steel (2 piece)
- (4) 5'H x 18"W x 2"D bolt-on wing panels made of 11 gauge perforated steel
- 3 Year Limited Warranty

Perm/Semi-Perm	<b>Yellow</b>	BBFP-30 (PAIR)
Perm/Semi-Perm	<b>White</b>	SBFP-30-WT (PAIR)
Perm/Semi-Perm	<b>Orange</b>	SBFP-30-OR (PAIR)
Surface Mount	<b>Yellow</b>	BBFP-30SM (PAIR)
Surface Mount	<b>White</b>	SBFP-30SM-WT (PAIR)
Surface Mount	<b>Orange</b>	SBFP-30SM-OR (PAIR)

**30' Ground Sleeves** FPS-30P (PAIR)

## 40' PROFESSIONAL FOUL POLE

- Main upright is 6½" OD Sch 40 zinc coated steel (2 piece)
- (6) 5'H x 18"W x 2"D bolt-on wing panels made of 11 gauge perforated steel
- 3 Year Limited Warranty

Perm/Semi-Perm	<b>Yellow</b>	BBFP-40 (PAIR)
Perm/Semi-Perm	<b>White</b>	SBFP-40-WT (PAIR)
Perm/Semi-Perm	<b>Orange</b>	SBFP-40-OR (PAIR)
Surface Mount	<b>Yellow</b>	BBFP-40SM (PAIR)
Surface Mount	<b>White</b>	SBFP-40SM-WT (PAIR)
Surface Mount	<b>Orange</b>	SBFP-40SM-OR (PAIR)

**40' Ground Sleeves** FPS-40 (PAIR)

For more information,  
scan below or go to:  
[www.Jaypro.com/Foul-Poles](http://www.Jaypro.com/Foul-Poles)





# COLLEGIATE FOUL POLES



Baseball and softball foul poles with a zinc undercoating and powder coat finish. Perm/Semi-Perm and Surface Mount installation available!

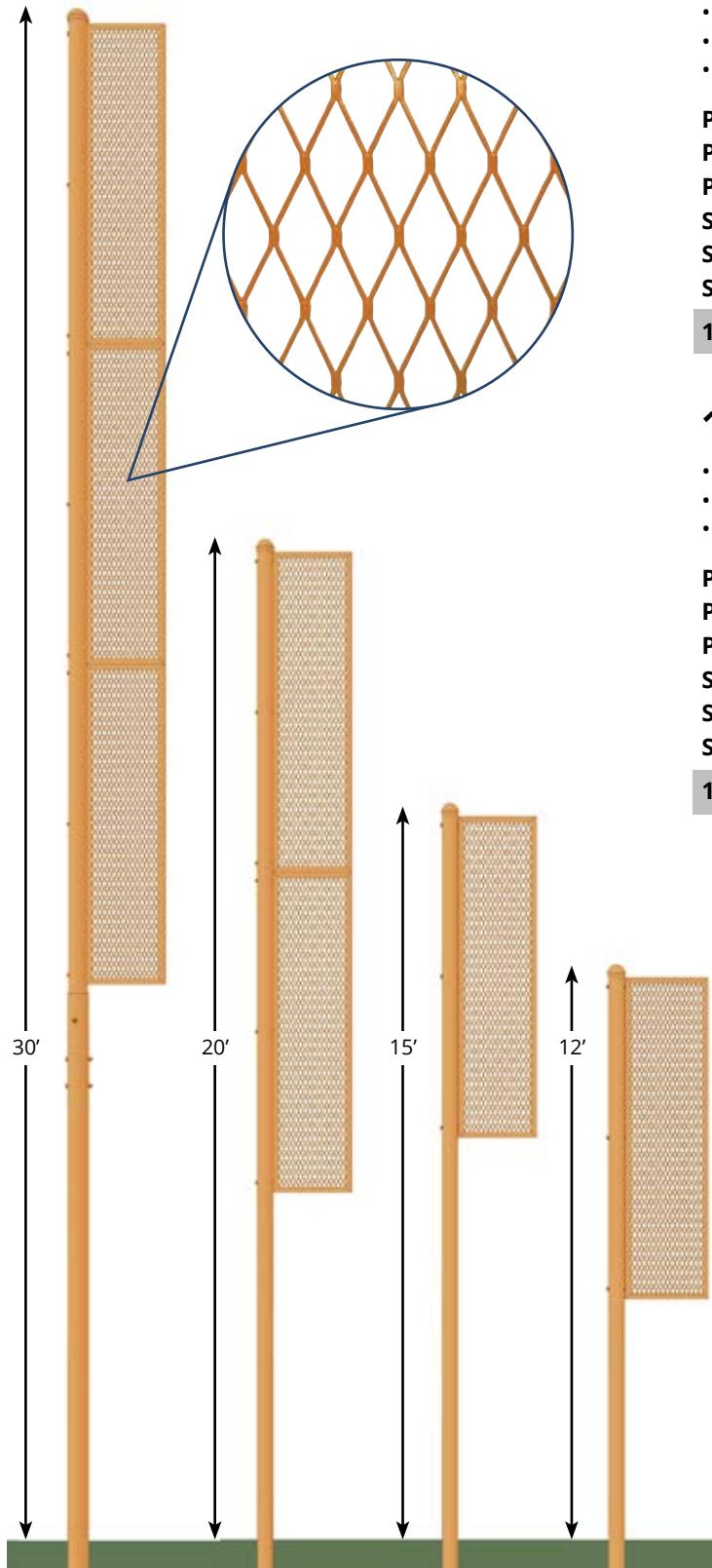

AVAILABLE IN: ● YELLOW   WHITE ● ORANGE

## 12' BASEBALL/SOFTBALL FOUL POLE

- 3½" heavy-duty steel tube pole (1 piece)
- (1) 6'H x 18"W bolt-on all steel expanded metal wing panel
- 3 Year Limited Warranty

<b>Perm/Semi-Perm</b>	<b>Yellow</b>	BBSBFP-12 (PAIR)
<b>Perm/Semi-Perm</b>	<b>White</b>	SBCFP-12-WT (PAIR)
<b>Perm/Semi-Perm</b>	<b>Orange</b>	SBCFP-12-OR (PAIR)
<b>Surface Mount</b>	<b>Yellow</b>	BBSBFP-12SM (PAIR)
<b>Surface Mount</b>	<b>White</b>	SBCFP-12-WTSM (PAIR)
<b>Surface Mount</b>	<b>Orange</b>	SBCFP-12-ORSM (PAIR)

**12' Ground Sleeves** FPS-12 (PAIR)

## 15' COLLEGIATE FOUL POLE

- 3½" heavy-duty steel tube pole (1 piece)
- (1) 6'H x 18"W bolt-on all steel expanded metal wing panel
- 3 Year Limited Warranty

<b>Perm/Semi-Perm</b>	<b>Yellow</b>	BBSBFP-15 (PAIR)
<b>Perm/Semi-Perm</b>	<b>White</b>	SBCFP-15-WT (PAIR)
<b>Perm/Semi-Perm</b>	<b>Orange</b>	SBCFP-15-OR (PAIR)
<b>Surface Mount</b>	<b>Yellow</b>	BBSBFP-15SM (PAIR)
<b>Surface Mount</b>	<b>White</b>	SBCFP-15-WTSM (PAIR)
<b>Surface Mount</b>	<b>Orange</b>	SBCFP-15-ORSM (PAIR)

**15' Ground Sleeves** FPS-12 (PAIR)

## 20' COLLEGIATE FOUL POLE



- 3½" heavy-duty steel tube pole (1 piece)
- (2) 6'H x 18"W bolt-on all steel expanded metal wing panels
- 3 Year Limited Warranty

<b>Perm/Semi-Perm</b>	<b>Yellow</b>	BBCFP-20 (PAIR)
<b>Perm/Semi-Perm</b>	<b>White</b>	SBCFP-200-WT (PAIR)
<b>Perm/Semi-Perm</b>	<b>Orange</b>	SBCFP-200-OR (PAIR)

**20' Ground Sleeves** FPS-20 (PAIR)

## 30' COLLEGIATE FOUL POLE

- 4½" heavy-duty steel tube pole (2 piece)
- (3) 6'H x 18"W bolt-on all steel expanded metal wing panels
- 3 Year Limited Warranty

<b>Perm/Semi-Perm</b>	<b>Yellow</b>	BBCFP-30 (PAIR)
<b>Perm/Semi-Perm</b>	<b>White</b>	SBCFP-30-WT (PAIR)
<b>Perm/Semi-Perm</b>	<b>Orange</b>	SBCFP-30-OR (PAIR)

**30' Ground Sleeves** FPS-30C (PAIR)



## BIG LEAGUE SCREENS



Larger size screens for pro players protects fielders from stray balls.

- 2" heavy-walled Schedule 40 aluminum design
- #42 knotless weatherproof double-sided slip-on net
- (2) 10" dia. x 4" wide no-flat tires
- 3 Year Limited Warranty on frame

### BIG LEAGUE PITCHERS SCREEN

- Heavy-duty welded leg supports
- Padded hip protector included

**8' x 8'** BLPS-84 (EACH)  
**8' x 8' Replacement Net** BLPS-84N (EACH)



### BIG LEAGUE FUNGO SCREEN

- Heavy-duty welded leg supports
- Available in two sizes

**8' x 8'** BLFS-88 (EACH)  
**10' x 10'** BLFS-101 (EACH)  
**8' x 8' Replacement Net** BLFS-88N (EACH)  
**10' x 10' Replacement Net** BLFS-101N (EACH)



### BIG LEAGUE FUNGO SCREEN W/WINGS

- Wings fold in for easy transport
- Center - 8'W x 8'H
- Wings - 4'W x 8'H

**Screen** BLFSW (EACH)  
**Replacement Wing Net** BLFSW-N (EACH)  
**Replacement Center Net** BLFS-88N (EACH)







PS-84

FS-77

FS-101

## COLLEGIATE SCREENS



Required protection screens for players during batting and fielding practice.

- 1½" heavy gauge galvanized steel design
- 2" sq. galvanized steel legs
- #36 knotless weatherproof double-sided slip-on net
- Optional wheel kit (BBWK-2) sold separately
- 3 Year Limited Warranty on frame



PS-84

### COLLEGIATE PITCHERS SCREEN

- 7' x 7' PS-84 (EACH)
- 7' x 7' Replacement Net PS-84N (EACH)

### COLLEGIATE FIELDERS SCREEN

- 7' x 7' FS-77 (EACH)
- 10' x 10' FS-101 (EACH)
- 7' x 7' Replacement Net FS-77N (EACH)
- 10' x 10' Replacement Net FS-101N (EACH)
- Wheel Kit BBWK-2 (EACH)



FS-77

# COLLEGIATE SCREENS



## SOFTBALL PROTECTOR SCREEN

- For softball pitchers
- Net included
- 7'H x 7'W frame with cutout
- 3 Year Limited Warranty on frame

**7' x 7'** SBPE-77 (EACH)  
**7' x 7' Replacement Net** SBPE-77N (EACH)



## PORTABLE SOFT TOSS/ BATting PRACTICE SCREEN

- Heavy-duty frame for baseball/softball practice
- Balls collect in sock for reuse
- Pillowcase style net included
- 3 Year Limited Warranty on frame

**7' x 7'** PSTS-77 (EACH)  
**7' x 7' Replacement Net** PSTS-77N (EACH)  
**7' x 6' Green Net** PSTS-76N (EACH)



## SHORT SIDED PITCHERS SCREEN

- Narrow width for use in batting tunnels or indoors
- 1 $\frac{5}{8}$ " heavy gauge galvanized steel design
- 2" sq. galvanized steel legs
- #36 knotless weatherproof double-sided slip-on nylon net
- 3 Year Limited Warranty on frame

**7' x 5'** PS-75 (EACH)  
**7' x 5' Replacement Net** PS-75N (EACH)



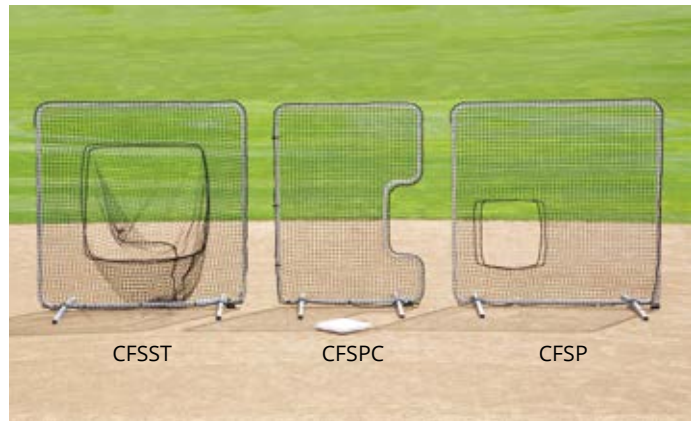

# CLASSIC BASEBALL & SOFTBALL SCREENS



Galvanized steel square frames with heavy-duty pillow-case style netting.

- 1½" sq. steel frames
- Nut/bolt assembly with detachable leg supports
- Swaged joints for easy assembly
- Optional wheel kit (CFS-WK) sold separately
- 3 Year Limited Warranty on frame



CFSL



CFS



CFSL2



CFSST



CFSPC



CFSP

## BASEBALL L-SCREEN

7' x 7' CFSL (EACH)

## BASEBALL FIELDERS SCREEN

7' x 7' CFS (EACH)

## BASEBALL L2 SCREEN

9' x 7' CFSL2 (EACH)

## BASEBALL/SOFTBALL SOFT TOSS

7' x 7' CFSST (EACH)

## SOFTBALL C-SHAPE

7' x 5' CFSPC (EACH)

## SOFTBALL PITCHING PROTECTOR

7' x 7' CFSP (EACH)

## WHEEL KIT

For Classic line CFS-WK (EACH)

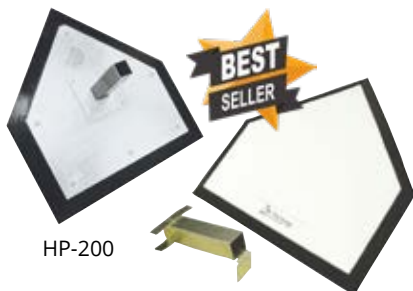

HP-200



HP-250

### MAJOR LEAGUE HOME PLATE

- Durable molded rubber design
- Stanchion-mounted steel plate
- Removes easily for maintenance and storage
- 1 Year Limited Warranty

#### Plate w/ 1½" Anchor

HP-200 (EACH)

#### Plate w/ 5 Zinc-Plated Spikes

HP-250 (EACH)



### PROFESSIONAL PITCHING RUBBERS

- Durable molded rubber design
- Interior PVC tube increases longevity
- Fill with dirt or concrete for added stability
- 1 Year Limited Warranty

#### Major League - 6" x 24"

PR-624 (EACH)

#### Little League - 4" x 18"

PR-618 (EACH)



### BURY-ALL HOME PLATE

- Wood-filled design with no corners/edges to catch spikes
- No-skid waterproof surface
- 1 Year Limited Warranty

HP-150 (EACH)



### BURY-ALL HOME PLATE

- Rubber design with no corners/edges to catch spikes
- No-skid waterproof surface
- 1 Year Limited Warranty

HP-100 (EACH)

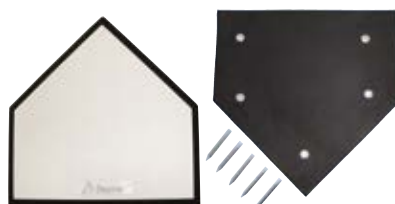

### ECONOMY HOME PLATE

- Durable molded rubber construction
- 5 removable spikes included
- 1 Year Limited Warranty

HP-50 (EACH)



### STEP DOWN PITCHING RUBBERS

- Heavy-duty all rubber design
- Step down style for better footing
- 1 Year Limited Warranty

#### Official - 24" long

PR-524 (EACH)

#### Youth - 18" long

PR-518 (EACH)

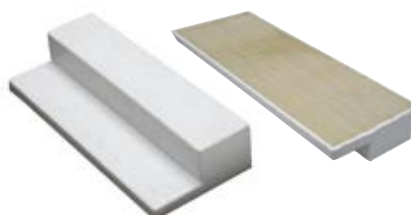

- Heavy-duty wood-filled design
- Step down style for better footing
- 1 Year Limited Warranty

#### Official - 24" long

PR-550 (EACH)



PR-424

### REMOVABLE PITCHING RUBBERS

- Heavy molded rubber
- Steel ground anchors included
- 1 Year Limited Warranty

#### Official - 24" long

PR-424 (EACH)

#### Youth - 18" long

PR-418 (EACH)



PR-324

### MOVABLE PITCHING RUBBER

- Heavy molded rubber
- 3 removable metal spikes included
- 1 Year Limited Warranty

#### Official - 24" long

PR-324 (EACH)

#### Youth - 18" long

PR-318 (EACH)





### PRO-STYLE HOLLYWOOD BASES

Used by the pros and ideal for advanced levels of play.

- 3 bases with a tapered lip that digs into the dirt
- 3 anchors and (3) 1½" solid rubber plugs included
- 15" x 15" x 3"
- 1 Year Limited Warranty

BB-500 (SET)



### FLEX STYLE BASES

Ideal for recreational or competition levels of play.

- 3 bases are shock absorbing and compress on impact
- 3 anchors and (3) 1½" solid rubber plugs included
- 15" x 15" x 3"
- 1 Year Limited Warranty

BB-200 (SET)



### FLEX STYLE DOUBLE FIRST BASE

- Double first base reduces collisions and compresses on impact
- 2 anchors and (2) 1½" solid rubber plugs included
- 30" x 15" x 3"
- 1 Year Limited Warranty

BB-400 (EACH)



### BREAKAWAY STYLE BASES

Fully compliant with Little League® Rule 1.06

- 3 quick release bases disengage upon impact
- 3 anchors and 1½" solid rubber plugs included
- 15" x 15" x 3"
- 1 Year Limited Warranty

BB-700 (SET)

### RECREATION DOUBLE FIRST BASE



- Foam-filled with nylon quilted cover
- Straps and 3 spikes included
- 30" x 15" x 3"
- 1 Year Limited Warranty

BB-150 (EACH)



### RUBBER THROW DOWN

- Heavy-duty molded rubber with waffle bottom
- Bases are 13½" square and ½" thick
- 1 Year Limited Warranty

**Home Plate** HP-300 (EACH)

**Bases (Set of 3)** BB-350 (EACH)

### OFFICIAL SIZE ECONOMY BASES



- 3 foam-filled bases with heavy-duty quilted covers, straps and anchors
- Straps and 3 spikes included
- 15" x 15" x 3"
- 1 Year Limited Warranty

BB-100 (SET)



### THROW DOWN BASES

- Flexible and washable rubber bases for indoor/outdoor use
- 3 bases, home plate and pitching rubber included
- 1 Year Limited Warranty

BB-50 (SET)

### HOME PLATE EXTENSION



- Provides an extended strike zone
- More visible for umpires to make calls
- White molded vinyl composition
- 1 Year Limited Warranty

HPEXT (EACH)



BBBCART



BB-500

# STACKMASTER™ PROFESSIONAL BASE PACKAGE

Package Includes:

- Pro-Style Hollywood Bases (BB-500)
- StackMaster™ Professional Base Cart (BBBCART)

BCARTSET (PKG)



# STACKMASTER™

## PROFESSIONAL BASE CART

Transports and stores heavy pro bases and male/female receptacles.

- Heavy-duty square steel frame
- Pneumatic tires for easy mobility
- 3 Year Limited Warranty

*Cannot be used with Flex Style Bases (BB-200) or Double First Bases (BB-400).*

BBBCART (EACH)

## REPLACEMENT PARTS

### BASE DIG-OUT TOOL

BB-DIGOUT (EACH)

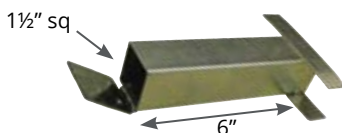

### BASE ANCHORS

BB-ANCHOR (EACH)

### BASE RUBBER PLUG

BB-PLUG (EACH)

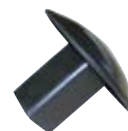

### BIG LEAGUE BASE PLUG

- For both 1 1/2" and 1 3/4" sleeves
- Order 3 for a complete set

BB-BLBP (EACH)



### REPLACEMENT STANCHION

- For BB-200 and BB-400

BB-RAP (EACH)

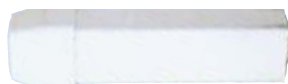

### 1 1/2" BASE ANCHORS

BB-ANCHOR150 (EACH)







### BALL CART

- Heavy-duty steel ball cart with oversized no-flat wheels
- 16"H x 17"W x 24"D basket
- Size: 45½"H x 23¾"W x 31"D
- 3 Year Limited Warranty

BCT-100 (EACH)



### CARRY BAG

- Stores up to 64 baseballs or 36 softballs - strap included
- 12"W x 14"H x 12"D
- 1 Year Limited Warranty

RBF-BASE (EACH)



### HANGING BAT RACK

- Heavy-duty powder coated steel bat rack holds up to 14 bats
- Attaches to dugout wall with included hardware
- 3 Year Limited Warranty

PBR-14WM (EACH)



### PERMANENT BAT RACK

- Heavy-duty powder coated steel bat rack holds up to 14 bats
- Permanently mounts to dugout surface
- 3 Year Limited Warranty

PBR-14 (EACH)



### STACKMASTER™ BATTING HELMET STORAGE RACK

- Galvanized steel frame stores up to (12) helmets
- Anchor to ground is recommended for secure installation
- 3 Year Limited Warranty

BHR-1 (EACH)



### OUTFIELD DISTANCE MARKERS



- Printed digitally on 13 oz. reinforced vinyl fabric
- 1 Year Limited Warranty

*Specify vinyl color, numbers, and number color when ordering.*

**27" x 36" Marker w/ 18" Numbers**

ODM-23 (EACH)

**38" x 56" Marker w/ 24" Numbers**

ODM-35 (EACH)

**VINYL PAD COLORS:**



**NUMBER COLORS:**



### PRE-ASSEMBLED ANCHOR FOUNDATION

- Pre-assembled recycled rubber base foundation is ready to install
- Fits 1½" anchors and includes a polycarbonate stem
- Base(s) sold separately
- 1 Year Limited Warranty on frame

*For Hollywood, Magnetic, Bolco Style Bases.  
Call for freight quote.*

**Single** PABF1 (EACH)

**Set of 3** PABF3 (EACH)

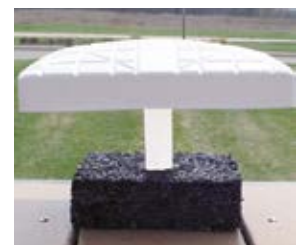

## 10" H ADULT GAME MOUND



Unique gel coat-down design is weather and UV resistant, with launch pad included.

- Portable (4 person) 10" high mound
- Used for distances of 60'6"
- Room for pickoffs
- 10"H x 8"W x 12"L
- 10 Year Warranty on mound core

Call for freight quote.

PPM8121 (EACH)



## 6" H YOUTH PITCHING MOUND



Unique gel coat-down design is weather and UV resistant, with launch pad included.

- Full size 6" H portable game mound
- Ages: 9-14
- 6"H x 7"W x 9"L
- 10 Year Warranty on mound core

Call for freight quote.

PPM796 (EACH)



## JUNIOR MOUNDS



Convert a softball field to a youth baseball field. Meets official Little League height specifications!

- Indoor/outdoor design with spike-proof 75 oz. artificial turf - pitching rubber included
- 1 Year Limited Warranty on frame

Call for freight quote.

### Junior Game Mound (9'L x 5' 4"W x 6"H)

**Green** PPM-660G (EACH)

**Clay** PPM-660CL (EACH)

### Pony Game Mound (54"L x 49"W x 6"H)

**Green** PPM-652G (EACH)

**Clay** PPM-652CL (EACH)



Junior Game Mound



Pony Game Mound



## 10" H PRO GAME MOUND



Model is a six piece "snap together" game mound designed straight from the MLB Rulebook.

- 4 sided pitching rubber
- Full size mound for Pro level use
- 18' diameter, 10" height

Call for freight quote.

PPM1810 (EACH)



## FIELD ARMOR PANELS

Dramatically decreases repetitive field maintenance and keeps a consistent playing surface!



FASB28

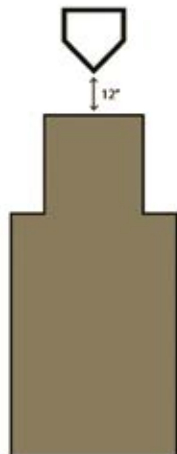

FACP48

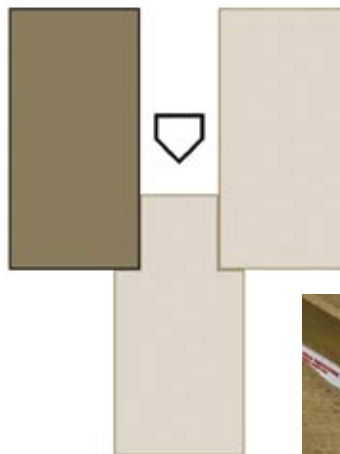

FASP48



Fortification panel

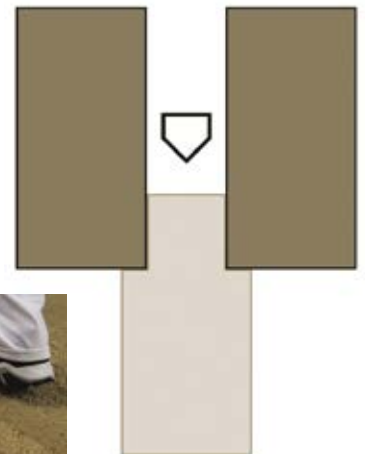

FASP2PK

## SOFTBALL PITCH PANEL

- Protects pitching area
- Eliminates ruts, holes, and standing water
- Dramatically reduces field maintenance
- 2'8" W x 8'L x 2"H

Call for freight quote.

FASB28 (EACH)

## CATCHER'S BOX PANEL

- Protects catching area
- Eliminates ruts, holes, and standing water
- Dramatically reduces field maintenance
- 4' W x 8'L x 2"H

Call for freight quote.

FACP48 (EACH)

## STANDARD BOX PANEL

- Protects batting area
- Eliminates ruts, holes, and standing water
- Dramatically reduces field maintenance
- 4' W x 8'L x 2"H

Call for freight quote.

### Baseball Box - 1 Panel

FASP48 (EACH)

### Baseball Box - 2 Panels

FASP2PK (SET)

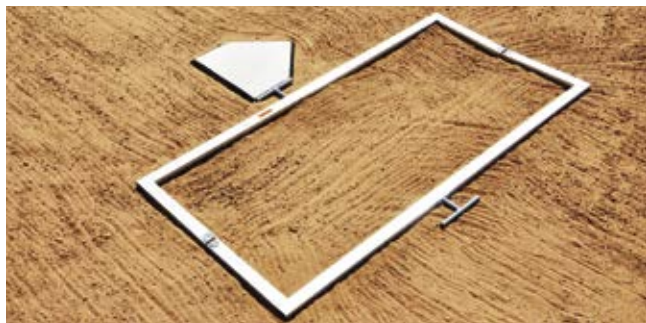

## BATTER'S BOX TEMPLATE

- Lightweight aluminum frame template imprints 2" pattern for chalking
- Carry handle aligns with home plate for proper positioning
- Folds for easy transport and storage
- 1 Year Limited Warranty

<b>Official - 4' x 6'</b>	BBTMOFF (EACH)
<b>Little League - 3' x 6'</b>	BBTMLL (EACH)
<b>Softball - 3' x 7'</b>	BBTMSB (EACH)



## ADJUSTABLE BATTER'S BOX TEMPLATE

- Made of 1" square galvanized steel
- Adjustable for 3' x 6' (youth league), 3' x 7' (softball), and 4' x 6' (official baseball)
- Line up markers ensure proper positioning on either side of home plate
- Product Dimensions: 4' 6"W x 7'L
- 1 Year Limited Warranty

ABBTM (EACH)

See (page 106-107) for our smaller field markers (FLMR-10) and (FLMR-25) to mark out your Batter's Box Template.

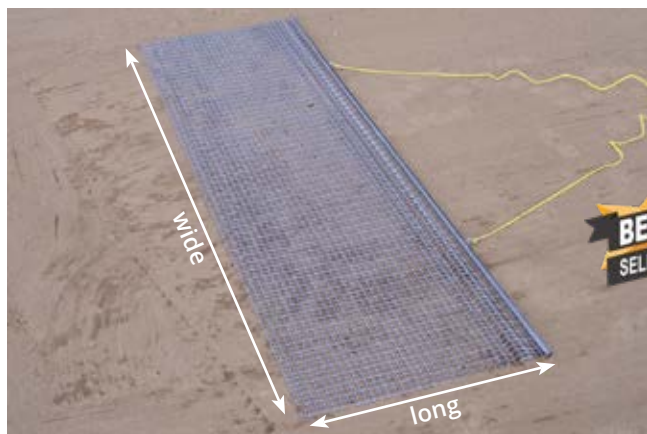

## INFIELD DRAG MAT

- Flexible plated steel mesh mat with 1 $\frac{1}{16}$ " galvanized steel drag bar
- $\frac{3}{8}$ " polypropylene rope handle
- 1 Year Limited Warranty

<b>4'D x 3'W</b>	DM-34 (EACH)
<b>3'D x 5'W</b>	DM-5 (EACH)
<b>3'D x 6'W</b>	DM-63 (EACH)
<b>6'D x 6'W</b>	DM-6 (EACH)

## DIRT TAMP

- Durable all steel construction
- 12" double-dipped vinyl grip handle included
- 1 Year Limited Warranty

**8" x 8"**  
DT-88 (EACH)

**10" x 10"**  
DT-1010 (EACH)

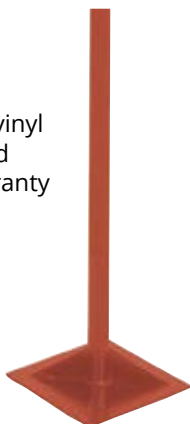

## LOOP HOE

- 60" powder coated aluminum handle with 6" non-slip vinyl grip
- 1 Year Limited Warranty

LH-60 (EACH)

## SIFTING SHOVEL

- Perforated scoop sifts debris from all types of soil
- 42" long handle with 14" x 17" scoop
- 1 Year Limited Warranty

SS42 (EACH)







### MONSTER DRAG BROOM

- Heavy-duty aluminum construction with foam covered handle
- 7' head with 2 rows of removable bristles
- 1 Year Limited Warranty

### DOUBLE PLAY MONSTER DRAG BROOM

- Heavy-duty aluminum construction with foam covered handle
- 7' head with scarifying edge and 2 rows of removable bristles
- 1 Year Limited Warranty



**Monster** MDB-84 (EACH)  
**Double Play** DPMDB-84 (EACH)



### DOUBLE PLAY SCARIFIER BROOM

- Aluminum powder coated blue handle
- 28" head with scarifying edge and two rows of removable bristles
- 1 Year Limited Warranty

DPSB-28 (EACH)



### BASE RUNNER RAKE

Lightweight aluminum/magnesium alloy rake breaks down for convenient storage.

- Telescopic fiberglass handle adjusts from 30" to 70"
- 36" grading edge with teeth
- 1 Year Limited Warranty

BRR-36 (EACH)

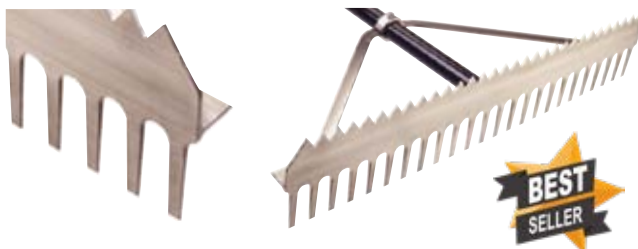

### DOUBLE PLAY RAKE

- High-grade aluminum head and bracing
- 66" powder coated aluminum handle with 5" no-slip vinyl grip
- 1 Year Limited Warranty

**24" Rake** DPR-24 (EACH)  
**36" Rake** DPR-36 (EACH)



### FIELD RAKE

- 66" lightweight aluminum/magnesium alloy head construction
- Large grading edge with heavy-duty cleaning teeth
- 1 Year Limited Warranty

**24" Rake** FR-24 (EACH)  
**36" Rake** FR-36 (EACH)  
**48" Rake** FR-48 (EACH)



# EasyLiner™

See (page 106-107) for product details on our EasyLiner™ Field Markers for your baseball field.

## Field Covers • Rolling Tubes Fitted Sideline Covers

Assorted sizes and colors available.  
Call customer service for details and freight quotes.



### WEIGHTED SPOT COVERS

- 6 oz. polyethylene cover with weighted hem - stakes/sand bags not required
- White/silver reversible colors
- 1 Year Limited Warranty

Call for freight quote.

Item #	Size	UoM
WWMC18	18' Round	(EACH)
WWMC20	20' Round	(EACH)
WWMC26	26' Round	(EACH)

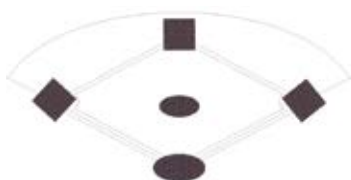

### SPOT COVERS

- 6 oz. rip-resistant woven polyethylene covers
- Heat sealed for waterproof protection
- Grommets spaced at 3' to 4' intervals
- Stakes included
- White/silver reversible colors
- 1 Year Limited Warranty

Call for freight quote.

Item #	Description	Size	UoM
AFC-PM	Pitchers Mound (7 stakes)	20' Round	(EACH)
AFC-HP	Home Plate (9 stakes)	26' Round	(EACH)
AFC-BC3	3 Bases (15 stakes)	10' x 10' Square	(SET)



### RAIN COVERS

- 18 oz. UV treated vinyl, mildew resistant
- Grommets installed every 3' around perimeter
- Includes low profile ground stakes
- 17 available colors
- 2 Year Prorated Warranty against UV sunlight breakdown

Call for color options and freight quote.

Item #	Size	UoM
BBRC10	10' Round	(EACH)
BBRC12	12' Round	(EACH)
BBRC18	18' Round	(EACH)
BBRC20	20' Round	(EACH)
BBRC26	26' Round	(EACH)

#### BASIC COLORS:

-  BLACK
-  NAVY BLUE
-  ROYAL BLUE
-  RED
-  DARK GREEN
-  ORANGE
-  YELLOW
-  PURPLE
-  LIGHT BLUE
-  MAROON



### WEIGHTED RAIN COVERS

- 18 oz. UV treated vinyl, mildew resistant
- Galvanized steel chain sewn into perimeter
- 17 available colors
- 2 Year Prorated Warranty against UV sunlight breakdown

Call for color options and freight quote.

Item #	Size	UoM
BBRCW12	12' Round	(EACH)
BBRCW18	18' Round	(EACH)
BBRCW20	20' Round	(EACH)
BBRCW26	26' Round	(EACH)



## PREMIUM WIND SCREEN

14 oz. / sq. yd. vinyl coated polyester mesh provides 75% shade.

- IncrediSeal™ heat sealed hems
- Grommets spaced every 18"
- Color options: Dark Green, Royal Blue, Red, Light Gray, Kelly Green, Maroon, Navy Blue, Purple, Orange, Carolina Blue, Yellow and White.
- Optional graphics available
- Wind vents and cable ties sold separately
- 5 Year Limited Warranty

Call for freight quote.



**6' Height** WSCRN-6 (SQ FT)  
**9' Height** WSCRN-9 (SQ FT)

### Graphic Lettering and Logos

WSCRNLG

#### WIND SCREEN COLORS:



DARK GREEN



ROYAL BLUE



RED



LIGHT GRAY



KELLY GREEN



MAROON



NAVY BLUE



BLACK



PURPLE



ORANGE



CAROLINA BLUE



YELLOW

## CLASSIC WIND SCREEN

8 oz. / sq. yd. vinyl coated polyester mesh provides 84% shade.

- IncrediSeal™ heat sealed hems
- Grommets spaced every 18"
- Graphics available
- Color options: Forest Green, Royal Blue, Black, Red, Navy Blue, Orange, Maroon, Carolina Blue, Brown, Tan, Purple, Kelly Green, White, Gray, and Yellow.
- Wind vents and cable ties sold separately
- 3 Year Limited Warranty

Call for freight quote.

Maximum length of a single piece wind screen is 100'. Screens over 100' will be made in sections. Custom heights above 6' will be charged at 9' pricing. Heights cannot exceed 9'. Wind screens higher than 6' require a centered horizontal lacing lip along entire length.



**6'H Screen** TWS-6 (SQ FT)  
**9'H Screen** TWS-9 (SQ FT)  
**Cable Ties (100)** PCT-100 (SET)  
**Half Moon Wind Flap** HMV-18 (EACH)

## OUTFIELD BATTER'S EYE

The batter's eye or batter's eye screen is a solid-colored, usually dark area beyond the center field wall of a baseball stadium, that is the visual backdrop directly in the line of sight of a baseball batter, while facing the pitcher and awaiting a pitch. This dark surface allows the batter to see the pitched ball against a sharply contrasted and uncluttered background. Its purpose is the safety and hitting success of the batter.



### Features:

- Size: 20'H x 40'L panel
- All I-beams are zinc primed and powder coated black
- Double single-piece black windscreen panel, front and back made from vinyl coated polyester mesh
- Includes all necessary assembly hardware
- Engineered to meet ASCE 7 105 MPH wind rating, exposure C
- Optional windscreen colors & graphics available

BE-24 (EACH)

Protective padding is an essential component for providing a safe athletic environment. Reduce the risk of injury from unpredictable ricochets from foul tips and passed balls on the baseball field. Keep in mind the contact that players will have with outdoor fencing or walls and the risks that come with them.

## WOOD BACKED PADDING



- 2" or 3" thick high-impact polyurethane foam
- 3/4" exterior grade sheathing, sealed and stained on all sides
- 18 oz. vinyl with UV protection
- Attachment: Z-clip (for wood and masonry walls) or Lag and Disc (for chain link fence)
- Available in several sizes and with returns
- Optional graphics available (call for details)
- See below for vinyl colors (specify when ordering)

Call for freight quote.

Item #	Size	UoM
WPO-44	4'H x 4'L	(EACH)
WPO-46	4'H x 6'L	(EACH)
WPO-48	4'H x 8'L	(EACH)

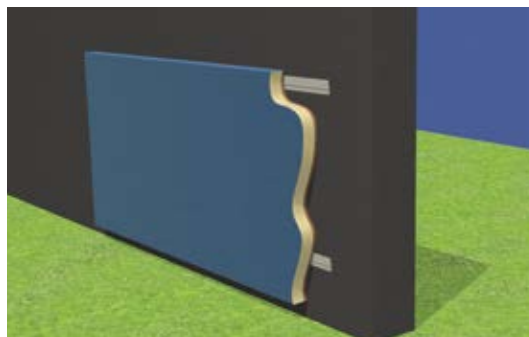

Z-clip attachment to a solid wall or structure



Lag and disc attachment to a chain link fence

## SEWN PADDING WITH GROMMETS



- 2" thick high-impact polyurethane foam
- 18 oz. vinyl with UV protection
- Sewn pad with 2" reinforced vinyl flap on top and bottom
- Brass grommets spaced every 12"
- Available in several sizes
- Optional graphics available (call for details and pricing)
- See below for vinyl colors (specify when ordering)

Call for freight quote.

Item #	Size	UoM
BSP236	3'H x 6'L	(EACH)
BSP238	3'H x 8'L	(EACH)
BSP2310	3'H x 10'L	(EACH)
BSP2312	3'H x 12'L	(EACH)
BSP246	4'H x 6'L	(EACH)
BSP248	4'H x 8'L	(EACH)
BSP2410	4'H x 10'L	(EACH)
BSP2412	4'H x 12'L	(EACH)



Top and bottom grommet attach to chain link fence

**VINYL PAD COLORS:**







## FENCE TOP PROTECTION



- 4½" dia. pre-slit corrugated polyethylene for durability and UV protection
- Secure with tie wraps every 2' (sold separately)
- Color: Yellow (YW), Black (BK)
- 2 Year Limited Warranty



<b>100' Roll</b>	CFC-100XX (EACH)
<b>250' Roll</b>	CFC-250XX (EACH)
<b>19" Ties (Bag of 100)</b>	CFC-TIESXX (SET)
<b>Installation Tool</b>	CFC-ITOOX (EACH)



### COLORS:

-  RED (RD)
-  WHITE (WH)
-  YELLOW (YW)
-  FOREST GREEN (FG)
-  ROYAL BLUE (RB)
-  ORANGE (OR)

## FENCE GUARD



- Maintenance free exterior grade UV-resistant polyethylene
- Set of (12) 7' sections are pre-drilled every 2'
- Available in 6 colors
- Fence guard ties included
- 3 Year Limited Warranty

Call for freight quote.

STC-8XX (SET)

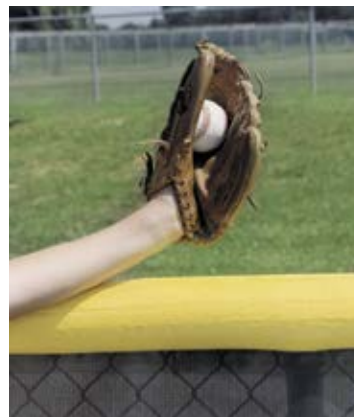

## SAFEFOAM TUBULAR PADDING

- Tubular thick foam padding with durable skin coating
- Fits any 2½" dia. or less round pipe
- 8' long sections pre-slit for installation
- Minimum order of 6 pieces
- Secure with tie wraps every 2' (Yellow or Black, sold separately)
- Colors: Yellow (YW), Royal Blue (RB), Red (RD) and Green (GR)
- 1 Year Limited Warranty

Call for freight quote.

<b>Padding</b>	SF-PREMXX (EACH)
<b>100 Ties</b>	
<b>Yellow</b>	SF-TIESYW (SET)
<b>Black</b>	SF-TIESBK (SET)



## RAIL PADDING

- 2" thick foam in 6' long sections encased in 18 oz. vinyl
- Fits 2" outside diameter pipe
- Grommets every 6" for attachment
- Color options: Maple Green, Royal Blue, Red, Navy Blue, Gray, Maroon, Sky Blue, Purple, Yellow, White, Tan, Black, Kelly Green and Orange
- 1 Year Limited Warranty

Call for freight quote.

PRAFTP6 (PER 6' SECTION)



# EasyLiner™

## EASYLINER™ FIELD MARKERS

The preferred line marker for small to large fields.

- 2" or 4" line marking
- Durable 18 gauge steel hopper and frame
- Instant on/off gate control
- 1 Year Limited Warranty

50/100 lb. models include line dispenser viewing window, side mounted storage box, and adjustable fold-in handles for compact storage.

<b>100 lb. capacity</b>	FLMR-100HD (EACH)
<b>50 lb. capacity</b>	FLMR-50HD (EACH)
<b>25 lb. capacity</b>	FLMR-25 (EACH)
<b>10 lb. capacity</b>	FLMR-10 (EACH)



100 lb. capacity  
10" no-flat wheels

Additional Field Marker Options Available. Visit our website at [www.Jaypro.com](http://www.Jaypro.com)



50 lb. capacity  
10" no-flat wheels



25 lb. capacity  
8" wheels



10 lb. capacity  
2" line marking

Basic and Deluxe Field Marking Packages available. Visit [www.Jaypro.com](http://www.Jaypro.com) for more information.

### ATHLETIC FIELD MARKING DUST



- Pure white & NCAA compliant
- Non-toxic & won't stain uniforms
- Pallet of (50) 50 lb. bags

Call for freight quote.

AFMD50 (EACH)







**ECONOMY PAINT MARKER**



- 2" to 4" line marking
- Aerosol paint sold separately
- 1 Year Limited Warranty

FME-501 (EACH)



**FIELD MARKING WAND**

- Lightweight single spray can dispenser
- Aerosol paint sold separately
- 1 Year Limited Warranty

FMWAND (EACH)



**PROLINE LAYOUT & MARKING SYSTEMS**

Quick and economical way to line athletic fields year after year. The rugged markers are designed to remain in the ground from year to year. Use the string to guide you for re-marking. Measure once, mark again and again.

- Different size sets for each sport
- Durable Polypropylene locators
- Locators, starting tool, and 600' cord included

*Call for freight quote.*

**12 pc. Baseball**  
FM-LM1 (SET)

**25 pc. Soccer**  
FM-LM2 (SET)

**50 pc. Football**  
FM-LM5 (SET)

**10 pc. Replacement**  
FM-LM0 (SET)



**PRO-STRIPE ATHLETIC FIELD MARKING PAINT**

- Concentrate can be diluted with water
- Natural/artificial turf-friendly
- Non-toxic, halogen-free, and won't stain uniforms
- 5 gallon container

**White**

FSP-5WT (EACH)

**Yellow**

FSP-5YW (EACH)

**AEROSOL PAINT**

Order by case or in bulk!



- Ozone friendly/No CFCs
- Universal spray tip included
- (12) 20 oz. cans per case



**White**

GL-101 (CASE)

**Royal Blue**

GL-107 (CASE)

**Yellow**

GL-108 (CASE)

**Red**

GL-110 (CASE)

**AEROSOL PAINT (BULK)**



- Pallet of 60 cases ((12) 20 oz. cans per case)

*Call for freight and bulk pricing.*

**White**

PNTPKG-1 (PALLET)

# ELITE 9600

8' Extension



153¼"L x 72"W x 81"H

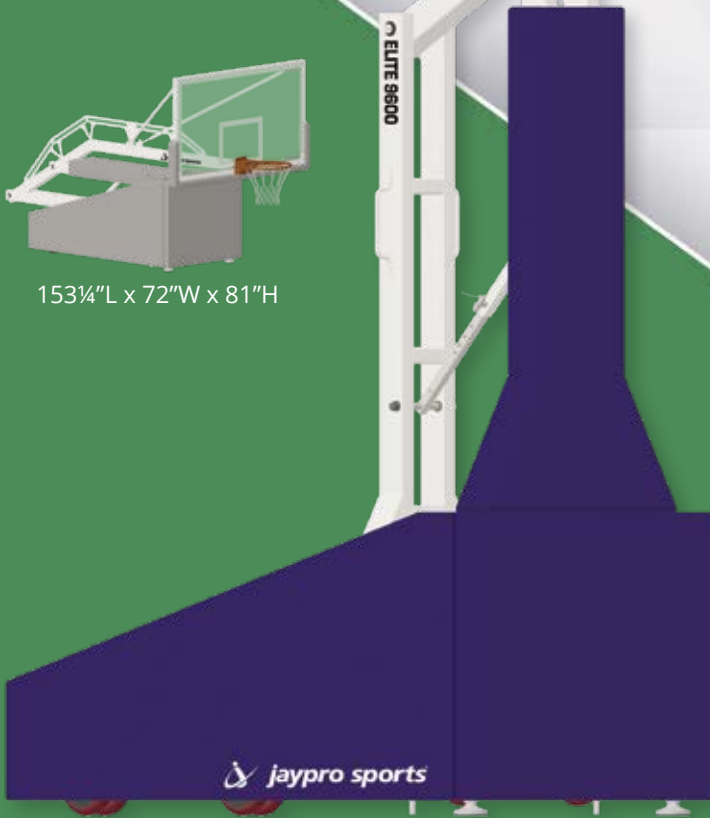

## Elite 9600 Portable Includes:



Rectangular Glass Backboard  
with Direct Goal Mounting  
42" x 72"



GBA-642 Adjustable  
Breakaway Goal



2" thick Vinyl  
Wrapping Padding



MBBP-6 Bolt-on Safety  
Edge Padding



Ballast Weight  
1,000 lbs

## VINYL PAD COLORS:





# ELITE 6600

5' 6" Extension



123¼"L x 72"W x 80¾"H

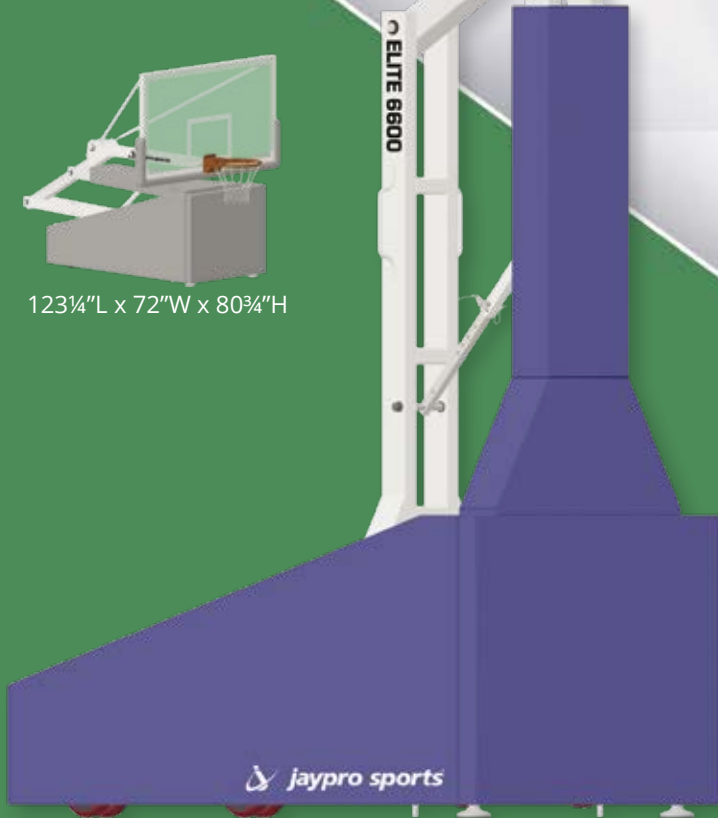

All Elite Series portables feature a spring assisted mechanism allowing easy operation and goal height adjustments. Each portable includes non-marking heavy-duty casters to easily transport, and easy set-up with adjustable front feet to level each unit.

Adjustable 8' - 10' goal height with pin stops every 6" for alternate playing heights. A durable white powder coat finish with padding available in 14 colors. Easily folds down to a compact storage position. Ballast weight of 800-1000 lbs. is included.

- 3 Year Limited Warranty on system



Flatbed tow truck, forklift or loading dock required to unload this system. Call for freight quote.

## ELITE 9600 PORTABLE BACKSTOP

8' Extension PBEL96 (EACH)

## ELITE 6600 PORTABLE BACKSTOP

5' 6" Extension PBEL66 (EACH)

Rear Anchor Kit (see page 111 for details)

Elite 6600 Portable Includes:



Rectangular Glass Backboard with Direct Goal Mounting  
42" x 72"



GBA-642 Adjustable Breakaway Goal



2" thick Vinyl Wrapping Padding



MBBP-6 Bolt-on Safety Edge Padding



Ballast Weight  
800 lbs

VINYL PAD  
COLORS:



RED



NAVY  
BLUE



FOREST  
GREEN



BLACK



ROYAL  
BLUE



GRAY



MAROON



PURPLE



KELLY  
GREEN



YELLOW



PINK



TAN



ORANGE



LIGHT  
BLUE

# ELITE 5400

4' 6" Extension



110¾"L x 72"/54"W x 79¼"H

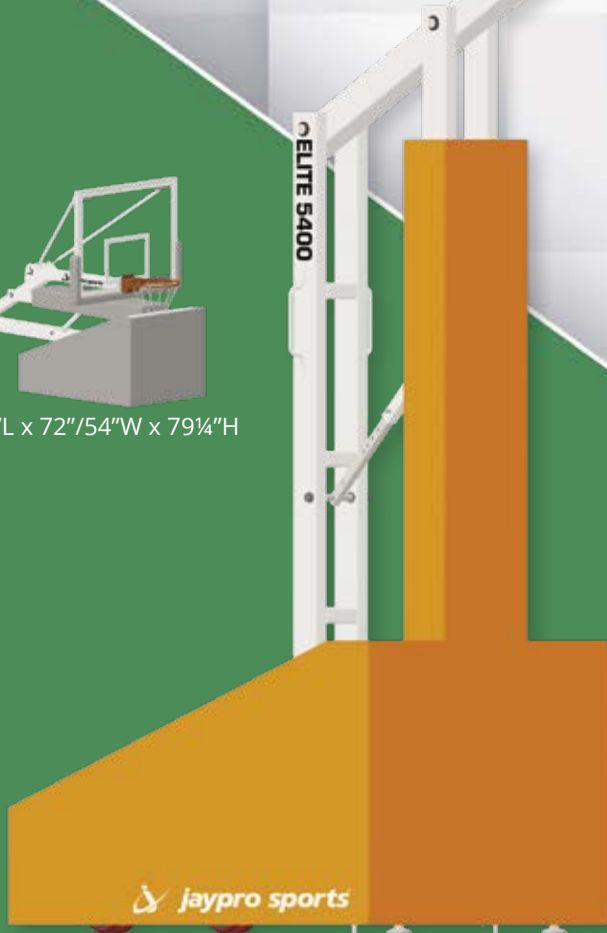

## ELITE 5400 PORTABLE BACKSTOP

- PBEL54 Edge Pad colors: Scarlet Red, Gray, Black and Royal Blue only
- 3 Year Limited Warranty on system



*Flatbed tow truck, forklift or loading dock required to unload this system. Call for freight quote.*

### 4' 6" Extension

**54" Backboard** PBEL54 (EACH)

**72" Backboard** PBEL5472 (EACH)

**Rear Anchor Kit** (see page 111 for details)

Elite 5400 Portable Includes:



Rectangular Glass Backboard with Direct Goal Mounting  
42" x 72" or 42" x 54"



GBA-642 Adjustable Breakaway Goal



2" thick Vinyl Wrapping Padding



MBBP-6 Bolt-on Safety Edge Padding



Ballast Weight 800 lbs

### VINYL PAD COLORS:





## PORTABLE BASKETBALL SYSTEM



- Adjusts 6'6" to 10' - no tools required
- 48" extension arm for "play safe" area
- 48" x 32" acrylic backboard and breakaway goal
- Backboard edge padding (EP-48) and rear anchor kit sold separately
- Customer supplied ballast required is 300-350 lbs.
- Portable system vinyl padding included
- Some assembly required
- 3 Year Limited Warranty on system

Call for freight quote.

**WARNING!** Failure to install customer supplied ballast according to instruction provided could result in serious injury.

<b>System</b>	PBB-200 (EACH)
<b>Edge Padding (Black)</b>	EP-48 (EACH)
<b>48" x 32" Backboard</b>	AB-4832 (EACH)
<b>Rear Anchor Kit</b>	(see below for details)

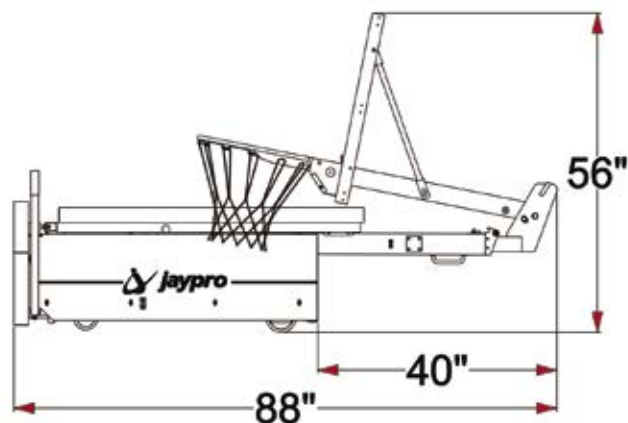
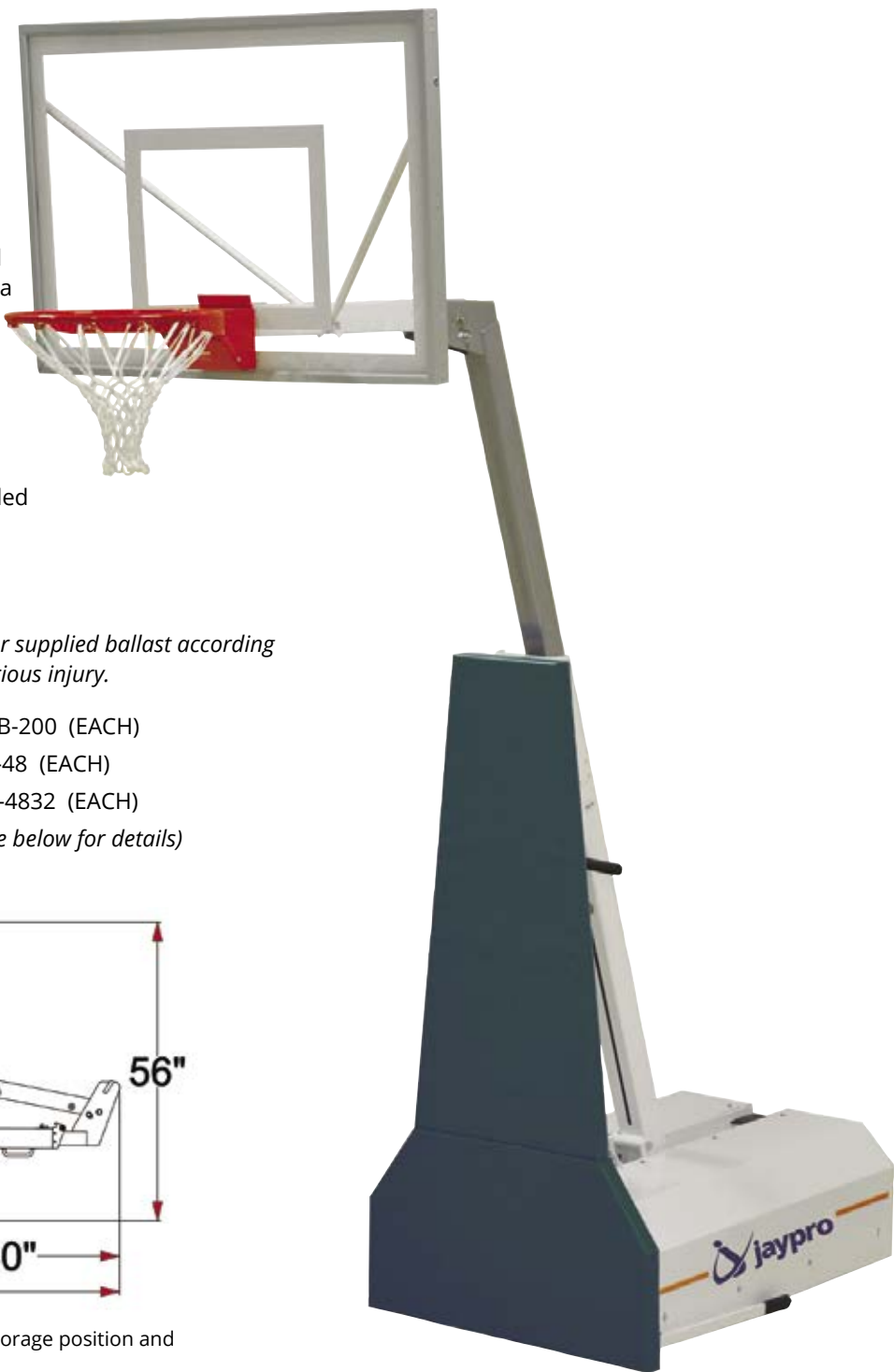

Portable system folds down to a compact storage position and fits through standard doorways (48" width).

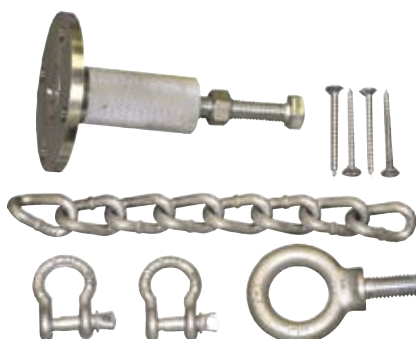

### REAR ANCHOR KIT

Includes all hardware to attach to built-in rear eye bolt on portable systems.

- 3 Year Limited Warranty

<b>For floating wood floors</b>	PBELKIT-100 (EACH)
<b>For other type floors</b>	PBELKIT-89 (EACH)



*Note: The glass itself is not unbreakable. Breakage in transit, during mounting, malicious acts, or deliberate attempts to damage are not covered under warranty. Boards used with height adjusters below 10' are not covered under warranty.*

### UNBREAKABLE RECTANGULAR GLASS BACKBOARD



1/2" thick tempered glass backboard designed for impact load on goal to transfer directly to a lower reinforced steel frame member without putting stress on glass. Indoor use only.

- Direct mount (4"x 5" hole pattern on GBRUB-42 or GBRUB-54) or 4 corner mounting
- Direct mount (5"x 5" hole pattern on GBAFR-48) or 4 corner mounting
- High strength clear anodized aluminum frame
- Pre-drilled for Safe-Pro™ Edge Padding (MBBP-6)
- Goal and net sold separately
- 3 Year Limited Warranty

**72" x 42" Backboard** GBRUB-42 (EACH)  
**54" x 42" Backboard** GBRUB-54 (EACH)

**GLASS BACKBOARD**  
**72" x 48" Backboard** GBAFR-48 (EACH)



## BACKBOARD PACKAGE



Unbreakable Glass Backboard



GBA-642 Adjustable Breakaway Goal



MBBP-6 Bolt-on Safety Edge Padding

### Unbreakable Replacement Package

Package Includes:  
 42" Unbreakable Glass Backboard GBRUB-42  
 Contender Pro Breakaway Goal GBA-642  
 Safe-Pro™ Edge Padding MBBP-6XX

BBRP-42 (PKG)

*Specify edge padding color when ordering.*





### 42" RECTANGULAR GLASS CONVERSION BACKBOARD



½" thick tempered glass backboard easily converts fan-shaped backboards to rectangular backboard. Eliminates need to alter playing court or backstop system. Indoor use only.

- Direct mount (4" x 5" hole pattern) or 4 corner mounting (20" x 35")
- High strength clear anodized aluminum frame
- Goal and net sold separately
- 3 Year Limited Warranty



**72" x 42" Backboard**

GCCB-35 (EACH)

## BACKBOARD PACKAGE



Glass Conversion Backboard



GBA-642 Adjustable Breakaway Goal



MBBP-6 Bolt-on Safety Edge Padding

### Glass Conversion Package

Package Includes:

42" Rectangular Glass Conversion Backboard	GCCB-35
Contender Pro Breakaway Goal	GBA-642
Safe-Pro™ Edge Padding	MBBP-6XX

GCCB-35PKG (PKG)

*Specify edge padding color when ordering.*



### PATENTED PERFORATED POLYCARBONATE BACKBOARD



Shatterproof backboard is 250x stronger and 30% lighter than conventional glass backboards. Retrofits most indoor/outdoor support structures! Will require mounting hardware specific to the existing pole/system. Indoor use only.

- ½" thick polycarbonate backboard with perforated holes
- Graffiti, UVF, and scratch resistant coating
- Goal, edge padding, and net sold separately
- 1 Year Limited Warranty

*Call for freight quote.*

#### OPTIONAL EDGE PAD COLORS:



<b>54" x 36" Backboard</b>	3654CB (EACH)
<b>72" x 42" Backboard</b>	4272CB (EACH)
<b>72" x 48" Backboard</b>	4872CB (EACH)



# BUILT FOR OUTDOOR USE

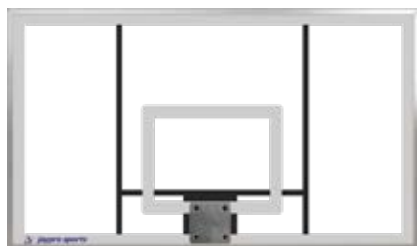

## 42" RECTANGULAR ACRYLIC BACKBOARD



- 5" x 5" goal mounting pattern
- Border and target included
- Goal and net sold separately
- Outdoor use only
- 72"W x 42"H
- 3 Year Limited Warranty

ACRB-72 (EACH)



## 36" RECTANGULAR ACRYLIC BACKBOARD



- 5" x 5" goal mounting pattern
- Border and target included
- Goal and net sold separately
- Outdoor use only
- 48"W x 36"H
- 3 Year Limited Warranty

LS-44AB (EACH)



## 42" RECTANGULAR PERFORATED STEEL BACKBOARD



- 5" x 5" goal mounting pattern
- Rear support frame allows for multiple mounting conversions
- 11 gauge steel face with ¼" dia. perforations
- Goal and net sold separately
- Outdoor use only
- 72"W x 42"H
- 3 Year Limited Warranty

SR-PERF (EACH)



## 42" RECTANGULAR STEEL BACKBOARD



- 5" x 5" goal mounting pattern
- 12 gauge steel with rear welded mounting pattern (35" x 20")
- Goal and net sold separately
- Outdoor use only
- 72"W x 42"H
- 3 Year Limited Warranty

850RB-BB (EACH)

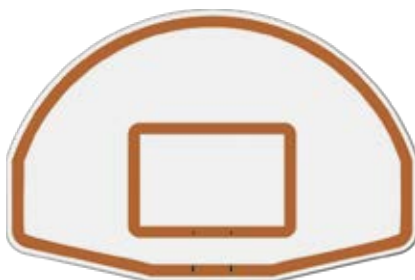

## 36" ALUMINUM FAN BACKBOARD



- 5" x 5" goal mounting pattern
- Cast aluminum with 1½" flange
- Goal and net sold separately
- Outdoor use only
- 54"W x 36"H
- 3 Year Limited Warranty

ALB-24BT (EACH)



## 42" RECTANGULAR PERFORATED ALUMINUM BACKBOARD



- 5" x 5" goal mounting pattern
- Rear support frame allows for multiple mounting conversions
- Aluminum face with ¼" dia. perforations
- Goal and net sold separately
- Outdoor use only
- 72"W x 42"H
- 3 Year Limited Warranty

AL-PERF (EACH)

# REVOLUTION SERIES

## REVOLUTION 180° FLEX GOAL



Designed for premier facilities that experience the need for higher performance goal.

- Flexes along 180 degree plain to eliminate snap back associated with traditional breakaway goals
- Tube-tie net attachment
- 5" x 4" mounting hole pattern
- Anti-whip net and mounting hardware included
- 5 Year Limited Warranty

*Check existing hole pattern for correct placement.*

**42" & 48" Backboard**    GBA-182 (EACH)  
**Replacement Ring**    BBSR-R (EACH)

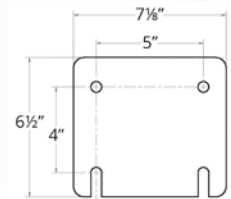

Mounting Plate





# CONTENDER SERIES

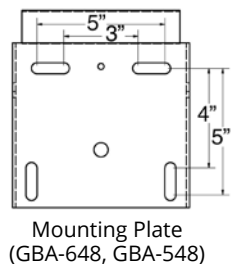
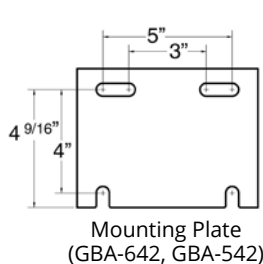

## CONTENDER PRO BREAKAWAY GOAL

(Tube-Tie Net Attachment)



Adjustable breakaway goal with excellent rebound consistency.

- Tube-tie net attachment system
- 5" x 5" or 5" x 4" mounting hole pattern (GBA-648)
- 5" x 4" mounting hole pattern (GBA-642)
- Anti-whip net and mounting hardware included
- 7 Year Limited Warranty

*Check existing hole pattern for correct placement.*

**42" Backboard** GBA-642 (EACH)

**42" & 48" Backboard** GBA-648 (EACH)

**Replacement Ring** BBSR-R (EACH)

## CONTENDER BREAKAWAY GOAL

(Traditional Net Attachment)



Adjustable breakaway goal with excellent rebound consistency.

- Traditional net attachment system
- 5" x 5" or 5" x 4" mounting hole pattern (GBA-548)
- 5" x 4" mounting hole pattern (GBA-542)
- Anti-whip net and mounting hardware included
- 7 Year Limited Warranty

*Check existing hole pattern for correct placement.*

**42" Backboard** GBA-542 (EACH)

**42" & 48" Backboard** GBA-548 (EACH)



# COMPETITOR SERIES

## COMPETITOR PRO BREAKAWAY GOAL (Tube-Tie Net Attachment)

**NCAA** COMPLIANT **NFHS** COMPLIANT

- Breakaway system that releases at 180 lb. static load
- Pro level tube-tie net attachment system
- 5" x 4" goal mounting pattern
- Nylon net and mounting hardware included
- 3 Year Limited Warranty

**42" Backboard** GBA-600 (EACH)  
**Replacement Ring** BBSR-R (EACH)

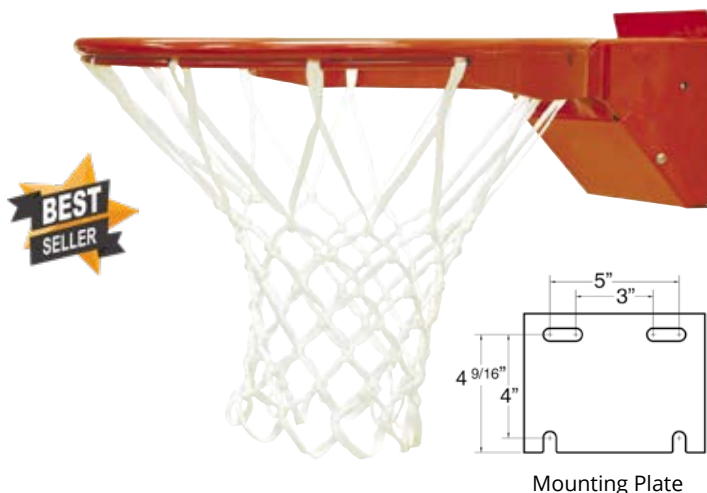

## COMPETITOR BREAKAWAY GOAL (Traditional Net Attachment)

**NCAA** COMPLIANT **NFHS** COMPLIANT

- Breakaway system that releases at 180 lb. static load
- Traditional net attachment system
- 5" x 4" goal mounting pattern
- Nylon net and mounting hardware included
- 3 Year Limited Warranty

**42" Backboard** GBA-342A (EACH)

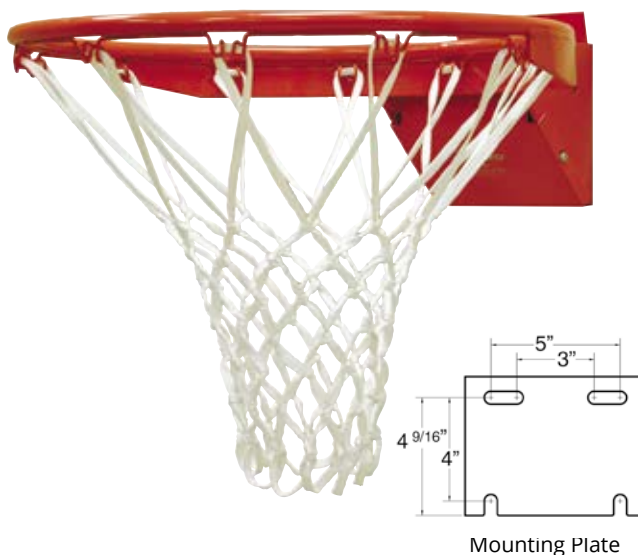

## BREAKAWAY GOAL

**NFHS** COMPLIANT

- Breakaway system that releases at 180 lb. static load
- Indoor/outdoor heavy-duty use
- Traditional net attachment system
- Three spring mechanism
- Fits 5"x 5" or 5"x 4" mounting hole pattern
- Nylon net and mounting hardware included
- 3 Year Limited Warranty

**42" & 48" Backboard** GBR360 (EACH)

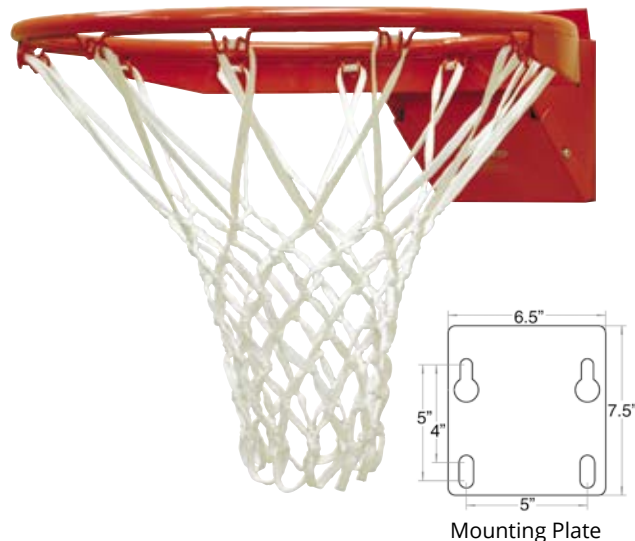



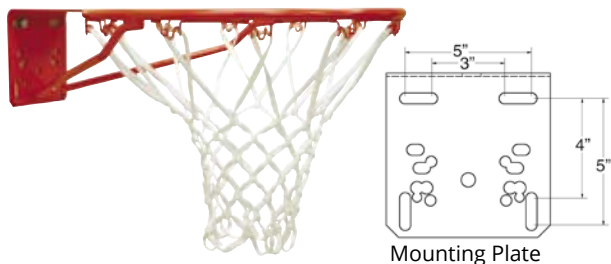

### SINGLE RIM GOAL

- Official size 18" ring with universal hole pattern - indoor/outdoor
- Nylon net and zinc plated mounting hardware included
- 3 Year Limited Warranty

GB-55 (EACH)

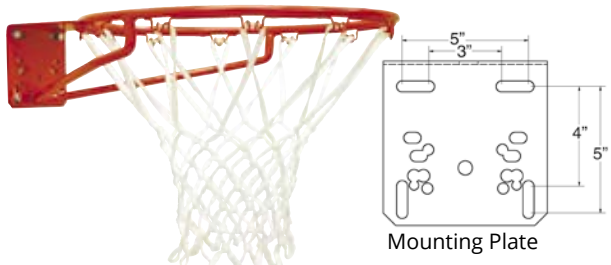

### SUPER GOAL



- Indoor/outdoor
- Official size high-strength rim with universal hole pattern
- Nylon net and zinc plated mounting hardware included
- 3 Year Limited Warranty

GBSG-50 (EACH)

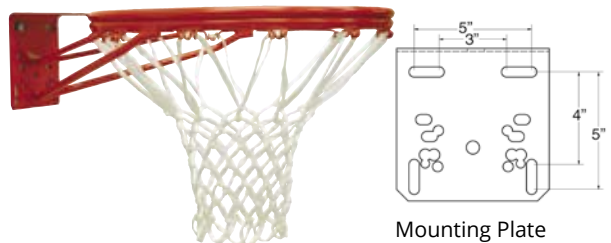

### DOUBLE RIM GOAL

- Official size 18" double ring of 5/8" steel and 1/2" welded together for added strength and rigidity with universal hole pattern - outdoor
- Nylon net and zinc plated mounting hardware included
- 3 Year Limited Warranty

GDR-54 (EACH)

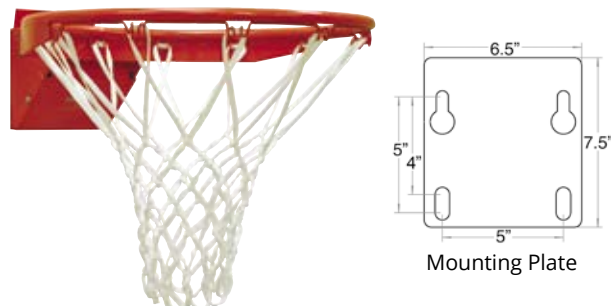

### FLEX GOAL

- Outdoor light-duty use
- Traditional net attachment system
- Two spring mechanism
- Fits 5"x 5" or 5"x 4" mounting hole pattern
- Nylon net and mounting hardware included
- 3 Year Limited Warranty

GBR361 (EACH)

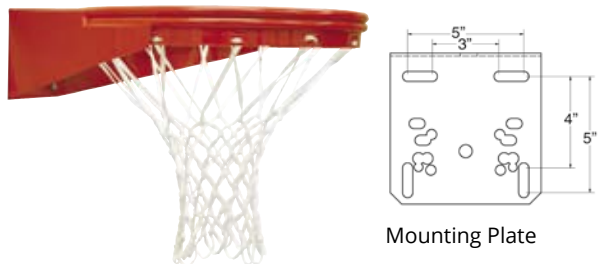

### PLAYGROUND GOAL

- Fixed double steel rim with no-fail net lock system and universal hole pattern - outdoor
- Nylon net included (can be used with a chain net)
- 3 Year Limited Warranty

UBG-500 (EACH)

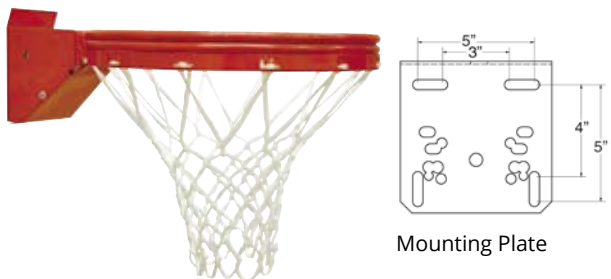

### PLAYGROUND BREAKAWAY GOAL

- Indoor/outdoor goal with universal hole pattern
- Nylon net included (can be used with a chain net)
- 3 Year Limited Warranty

UBG-500F (EACH)



### SHOOTERS RING

- Creates smaller diameter rim (16") for practice
- Attaches to standard basketball goals
- Requires no tools for easy install
- 3 Year Limited Warranty

SHOTRING (EACH)



### REBOUND RING

- Develops rebounding skills
- Keeps balls from falling through rim (10" inside diameter)
- Attaches to 18" goal with 3 screws
- 3 Year Limited Warranty

RBRING (EACH)

## REPLACEMENT NETS



### NYLON NET

- 12 loop net
- 680/32 braided
- 1 Year Limited Warranty

JNY-4HP (EACH)



### ANTI-WHIP NYLON NET

- 120 threaded 12 loop net
- Braided cord stops from flipping onto rim
- 1 Year Limited Warranty



**1 Net**                    JNY-6HP (EACH)  
**12 Nets**                JNY-6HP12 (PKG)  
**24 Nets**                JNY-6HP24 (PKG)



### STANDARD CHAIN NET

- Fits any style goal
- Heavy-duty "S" hooks
- 3 Year Limited Warranty

J-3 (EACH)



## EDGE PAD COLORS



## SAFE-PRO™ EDGE PADDING



- Bolts easily to all 72" official glass backboards
- Pin style attachment eliminates pad sagging under rim
- 10 Year Limited Warranty

MBBP-6XX (EACH)

<b>Pink</b>	MBBP-6PK	<b>Forest Green</b>	MBBP-6FG
<b>Cardinal Red</b>	MBBP-6C	<b>Orange</b>	MBBP-6OR
<b>Burnt Orange</b>	MBBP-6TO	<b>Maroon</b>	MBBP-6M
<b>Purple</b>	MBBP-6P	<b>Kelly Green</b>	MBBP-6KG
<b>Old Gold</b>	MBBP-6OG	<b>Black</b>	MBBP-6BK
<b>Royal Blue</b>	MBBP-6RB	<b>Columbia Blue</b>	MBBP-6CB
<b>Scarlet Red</b>	MBBP-6S	<b>Gray</b>	MBBP-6GY
<b>Navy Blue</b>	MBBP-6NB	<b>Light Purple</b>	MBBP-6LP
<b>Yellow</b>	MBBP-6YW		

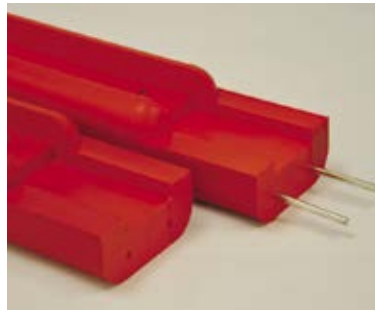

Bolt-on edge padding includes two steel connectors for perfect alignment



## SAFE-PRO™ 54" BOLT-ON EDGE PADDING

Bolts easily to all 54" glass backboards.

- 10 Year Limited Warranty

<b>Scarlet Red</b>	MBBP-54S (EACH)
<b>Gray</b>	MBBP-54GY (EACH)
<b>Black</b>	MBBP-54BK (EACH)
<b>Royal Blue</b>	MBBP-54RB (EACH)



## 1½" BOLT-ON EDGE PADDING

"L" shape molded padding for 48" indoor/outdoor wood or acrylic backboards.

- 3 Year Limited Warranty

**Black** EP-48 (EACH)

"L" shape molded padding for 72" indoor/outdoor wood or acrylic backboards.

**Black** EP-46 (EACH)

# WALL MOUNTED BACKSTOPS

## GLASS BOARD WALL-MOUNTED BACKSTOPS



- Available in Stationary, Fold-Up, or Side-Folding applications - Includes 42" Glass Board (GBRUB-42), Contender Pro Breakaway Goal (GBA-642), 1.90" OD heavy-duty black powder coated frame and wood stringers
- Fold-Up Systems operated with manual or electric winch (sold separately)
- Side-Fold Systems include manual pull-pin to lock unit in either playing or storage position
- Direct goal mounted to eliminate any strain on the board
- Requires cutting and drilling in the field to achieve desired extension off wall
- Refer to spec sheets for additional information, dimensional requirements, and structural requirements
- Wall anchors specified and supplied by installer
- 3 Year Limited Warranty on system

## WALL-MOUNTED BACKSTOPS OPTIONS:

- Manual or electric height adjuster (page 125)
- Backboard edge padding (page 121)

Visit [JAYPRO.COM](http://JAYPRO.COM) for product specifications

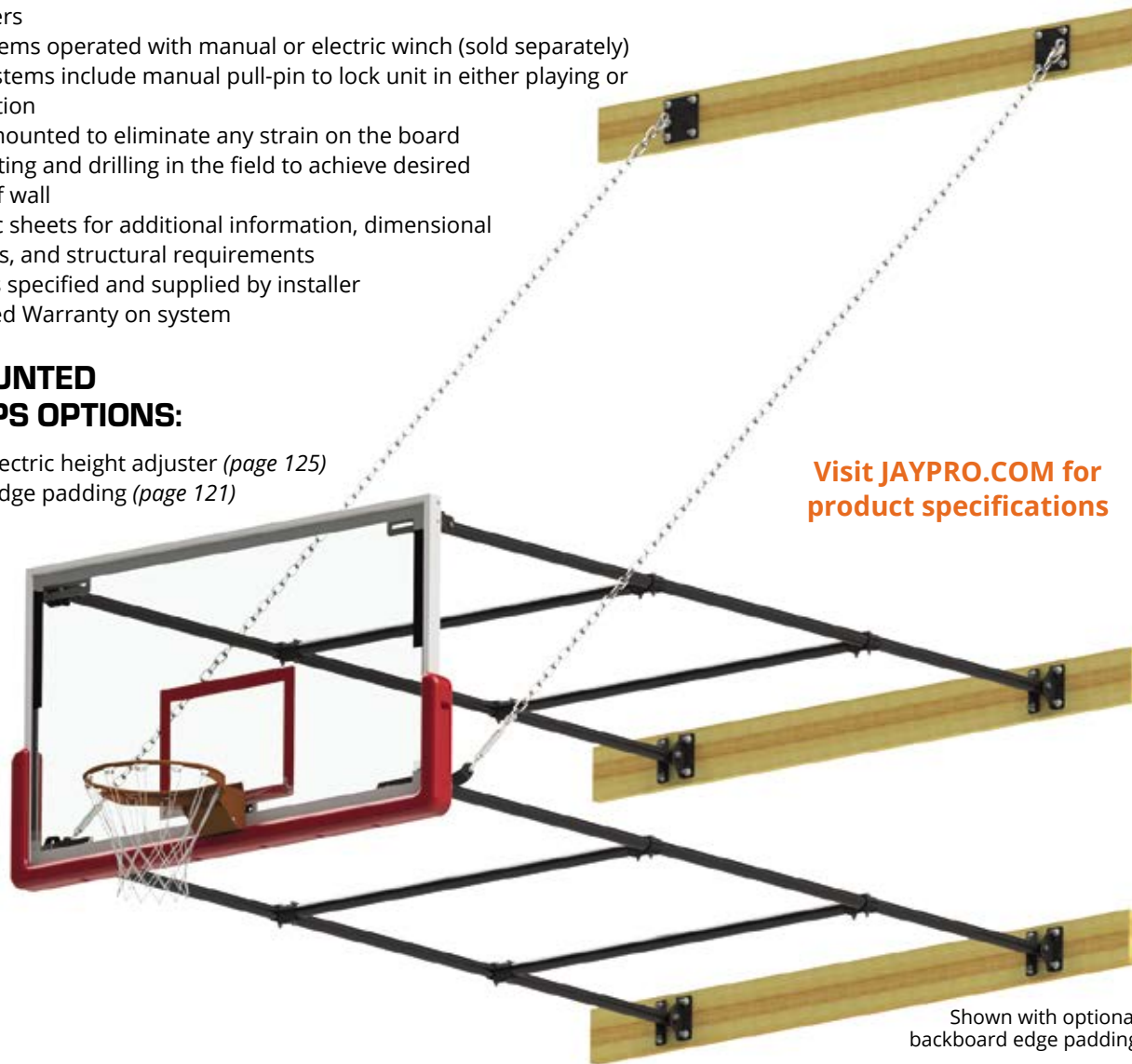

Shown with optional backboard edge padding

Stationary Backstop System		
Item #	Face of Bank	UoM

N24GB	2' - 4'	(SYS)
N46GB	4' - 6'	(SYS)
N68GB	6' - 8'	(SYS)
N810GB	8' - 10'	(SYS)
N1012GB	10' - 12'	(SYS)

Fold-Up Backstop System *		
Item #	Face of Bank	UoM

U46GB	4' - 6'	(SYS)
U68GB	6' - 8'	(SYS)
U810GB	8' - 10'	(SYS)
U1012GB	10' - 12'	(SYS)

\* Manual or electric winch and safety strap sold separately

Side-Fold Backstop System		
Item #	Face of Bank	UoM

S46GB	4' - 6'	(SYS)
S68GB	6' - 8'	(SYS)
S810GB	8' - 10'	(SYS)
S1012GB	10' - 12'	(SYS)

**Important notes for Wall-Mounted Backstops and Shooting Stations:** Wall-mounted backstop systems should only be installed on walls capable of supporting the weight of the equipment plus the additional weight of a player hanging on the rim. Consult an architect, structural engineer or contractor if necessary. Jaypro Sports bears no responsibility for the structural integrity of the wall the backstop is mounted on.



## 8'-10' HEIGHT ADJUSTER KITS FOR WALL-MOUNTED BACKSTOPS



- Kit includes height adjuster, board mounts, and hardware required to install on Stationary, Fold-Up, or Side-Fold Backstop Systems
- Choose between manual or electric height adjuster operation
- Various methods of operation available (*page 125*)
- Electric height adjusters may be hard wired or temporarily powered off a standard 120 volt electrical wall outlet
- 3 Year Limited Warranty



Wall-Mounted Backstop with Manual Height Adjuster

Item #	Height Adjuster	Method of Operation	UoM
SMHA-WM	Manual	Sold Separately	(EACH)
SEHA-WM-KS	Electric	Key Switch, Included	(EACH)
SEHA-WM-PW	Electric	Power Wand, Sold Separately	(EACH)
SEHA-WM	Electric	Other, Sold Separately	(EACH)

## 3-POINT STATIONARY FAN BOARD WALL-MOUNTED SHOOTING STATION



- Economy stationary wall-mounted shooting station includes 36" Aluminum Fan Board (ALB-24BT), Contender Breakaway Goal (GBA-548), 1.90" OD heavy-duty frame and wood stringers
- Direct goal mounted to eliminate any strain on the board
- Requires cutting and drilling in the field to achieve desired extension off wall
- Wall anchors specified and supplied by installer
- 3 Year Limited Warranty

Item #	Face of Bank	UoM
N2FB	6' - 2'	(SYS)
N236FB	2' - 3½'	(SYS)
N366FB	3' - 6½'	(SYS)
N68FB	6' - 8'	(SYS)
N810FB	8' - 10'	(SYS)

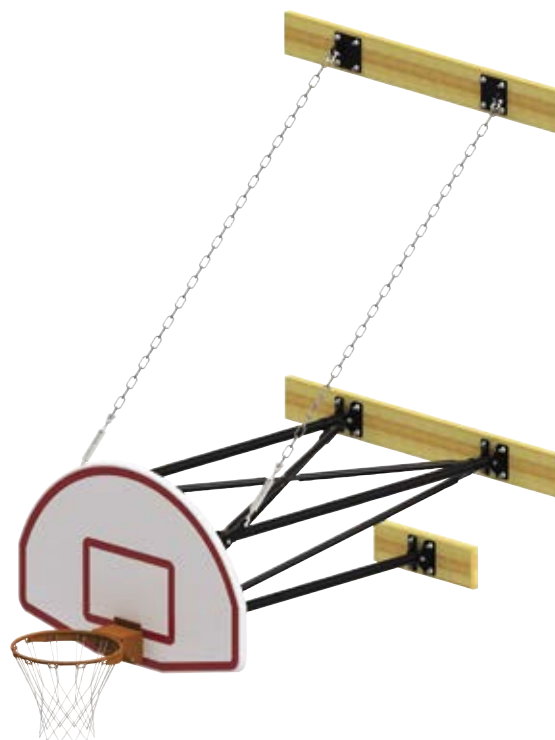

**Important notes for Wall-Mounted Backstops and Shooting Stations:** *Wall-mounted backstop systems should only be installed on walls capable of supporting the weight of the equipment plus the additional weight of a player hanging on the rim. Consult an architect, structural engineer or contractor if necessary. Jaypro Sports bears no responsibility for the structural integrity of the wall the backstop is mounted on.*



Shooting Station with Height Adjuster (Edge Padding sold separately)

## GLASS BOARD WALL-MOUNTED SHOOTING STATION



- Wall-mounted shooting station includes 42" Glass Backboard (GBRUB-42), Contender Pro Breakaway Goal (GBA-642), fully welded heavy duty 6 $\frac{5}{8}$ " OD frame with 2 $\frac{3}{8}$ " OD outriggers and wood stringers
- 3' Face of bank
- Available with or without 8' - 10' manual height adjuster (HAHC handle included)
- Wall anchors specified and supplied by installer
- 3 Year Limited Warranty

Item #	Description	UoM
WMWH	Station w/ Height Adjuster	(SYS)
WMSS	Station w/o Height Adjuster	(SYS)

## INDOOR/OUTDOOR ADJUSTABLE WALL-MOUNTED SHOOTING STATION



- Wall-mounted shooting station includes glass backboard, flex goal, heavy-duty steel frame, and black edge padding
- Rim height manually adjustable from 7'-6" to 10' with integral hand crank
- 33" - 44" extension off wall depending on height of rim
- Wall anchors specified and supplied by installer
- 3 Year Limited Warranty



Item #	Board Size	Board Type	UoM
WM-54	36" x 54" x 1/2"	Glass w/ Edge Padding	(SYS)
WM-65	36" x 60" x 1/2"	Glass w/ Edge Padding	(SYS)

**Important notes for Wall-Mounted Backstops and Shooting Stations:** *Wall-mounted backstop systems should only be installed on walls capable of supporting the weight of the equipment plus the additional weight of a player hanging on the rim. Consult an architect, structural engineer or contractor if necessary. Jaypro Sports bears no responsibility for the structural integrity of the wall the backstop is mounted on.*

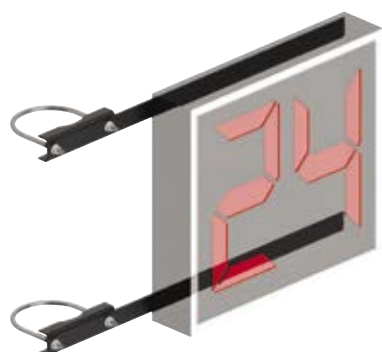

## SHOT CLOCK MOUNTING BRACKETS (ONLY)

Mount any shot clock to existing backstops.

<b>6<math>\frac{5}{8}</math>" OD Mast</b>	SCMB658-A
<b>6" OD Mast</b>	SCMB6-A
<b>2<math>\frac{3}{8}</math>" Double Drop</b>	SCMB238-A



# HEIGHT ADJUSTERS

Height Adjuster – Adjust the height of your backboard and rim from 10 ft. to 8 ft. for youth play. Jaypro’s Height Adjuster is stable and easy to operate. Constructed of slide steel frames, which provides tighter clearances resulting in less shake than other height adjusters on the market – even at lower playing heights. Choose either manual operation or electric.

## MANUAL HEIGHT ADJUSTER

Housing constructed of slide steel frames driven by a 3/4" Acme thread rod that easily raises and lowers the backboard with a manual hand crank (HAHC). Height markings are embossed into the side of the adjuster every 6" to allow the operator to establish an accurate height. The manual height adjuster may also be controlled using a portable Cordless Drill operator (CD-80H), purchased separately, which is a popular option when retrofitting new height adjusters on existing backstops.

SMHA (EACH)



## ELECTRICALLY OPERATED HEIGHT ADJUSTER

Electrical height adjusters make raising and lowering the backboard as easy as turning a key, radio remote, pluggable power wand, or operating with a touchscreen. The electric height adjuster is powered by a thermally protected 1/10 HP motor, requiring 110-120 volt, single phase, 1.35 amp motor with a 4' pigtail. Electric height adjusters may be hard wired, or temporarily powered off a standard 120 volt electrical wall outlet. This height adjuster includes a redundant hard stop safety feature to catch the board and goal in the event of a failure.

SEHA (EACH)



### HEIGHT ADJUSTER OPERATORS:

**Manual Height Adjuster Hand Crank**

HAHC (EACH)

**Manual Height Adjuster Cordless Operator**

CD-80H (EACH)

**Momentary Electric Key Switch**

KS-13 (EACH)

**Electric Height Adjuster Power Wand Controller\***

HAPW-100 (EACH)

\* For use with Jaypro branded Height Adjusters only

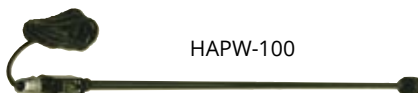
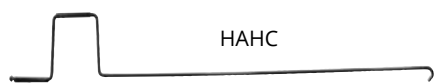

# LITTLE CHAMP™ BACKBOARD ADAPTERS

Convert an existing goal to youth height. Easily installs from floor by one person!



- Safely attaches to any goal and 42" backboard
- Fan-shaped backboard, attachment frame, official size goal, and nylon net included
- Moves backboard 2' closer to free throw line
- 3 Year Limited Warranty: System

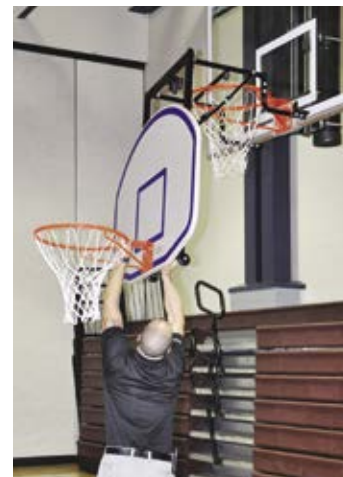
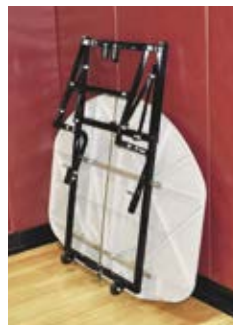
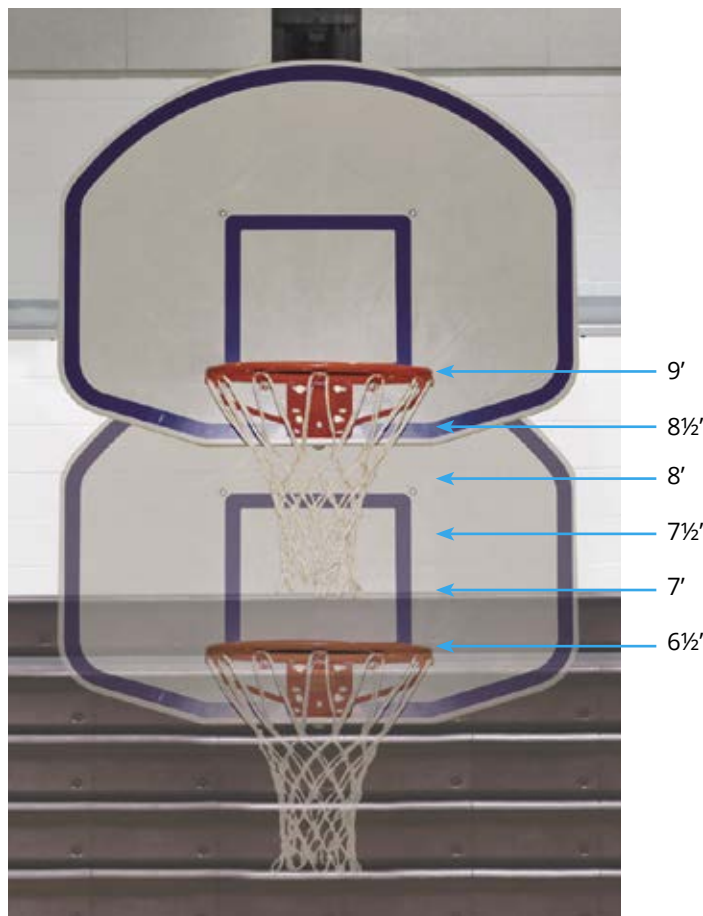

## LITTLE CHAMP™ EASY ADJUST BACKBOARD ADAPTER

- 6½' to 9' height adjustment without disassembly via pin-stop in 6" increments
- Folds down and rolls on wheels for convenient storage
- Arm adapter kit (LC-AKIT) for 48" backboard sold separately

LC-6HP (EACH)

LC-6 (PAIR)

## COURT/SIDE LINE HYDRATION CART



Roll from court to locker room with a fully loaded cart. Holds two medium trash bins underneath and 2, 3, 5, or 10 gallon coolers (not included). Heavy-duty frame with full side panels that can be used for logo's or school spirit.

- Heavy duty powder coated, welded steel construction
- Adjustable arms can adjust to your cooler size for added safety and will hold the cooler in place
- Can accommodate a cooler size up to 10 gallons (not included)
- (4) Non-marking casters with (2) wheels that can be locked
- For indoor and outdoor use
- Side panels are available for customization. Add your team or organization's logo
- Dimensions: 46" H x 26" L x 20" W
- 1 Year Limited Warranty

Keep your team hydrated! This cart is easy to move but steady when in place.



HCC-520 (EACH)





### DELUXE TRAINING BALL RACK

Durable steel rack for shooting competitions and free throw practice.

- Holds 19 regulation basketballs (top 7 feed to shooter)
- Non-marking swivel wheels (front 2 lockable)
- 61"L x 18"W x 44"H
- 3 Year Limited Warranty

DTBR-19 (EACH)

### PREMIUM BALL CARRIER

Durable steel frame carrier with side panels for optional custom graphics on both ends.

- Non-marking swivel wheels
- 39"L x 22"W x 36"H
- 3 Year Limited Warranty

**Carrier** DTBR-12 (EACH)

**Optional Graphics** DTBR-GRAPH (PAIR)

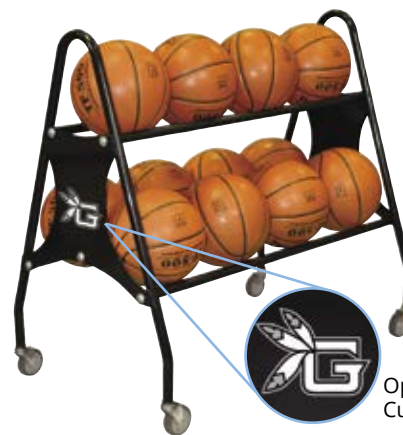

Optional Custom Graphics

BBC-18RB

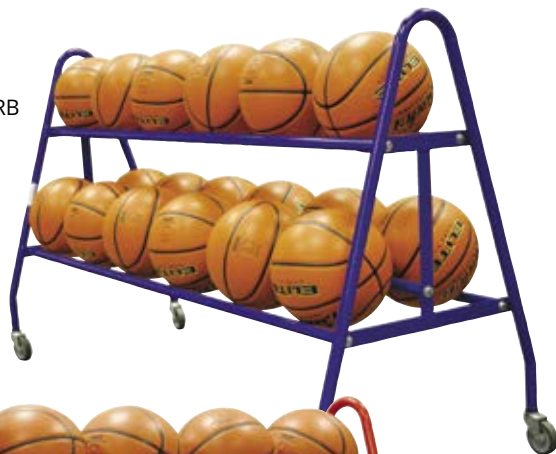

BBC-12RD

### DELUXE BALL CARRIERS

Durable steel frame carriers hold basketballs, volleyballs, and medicine balls.

- Non-marking swivel wheels
- 12 Ball Carrier - 39"L x 22"W x 36"H
- 18 Ball Carrier - 60"L x 22"W x 36"H
- 3 Year Limited Warranty

**12 Ball - Royal Blue** BBC-12RB (EACH)

**12 Ball - Black** BBC-12BK (EACH)

**12 Ball - Red** BBC-12RD (EACH)

**18 Ball - Royal Blue** BBC-18RB (EACH)

**18 Ball - Black** BBC-18BK (EACH)

**18 Ball - Red** BBC-18RD (EACH)

## COURTCLEAN

Get a safe, clean floor in minutes with this damp mop system.

- 6' mop made of polyethylene material
- Hook-and-loop fasteners keep towel in place
- Replacement towels sold separately
- 1 Year Limited Warranty

**6' Courtclean Mop** CCM-6 (EACH)

**6' Courtclean Towel** CCT-6 (EACH)

**1 gal. Super Shine-All** CCSS-1 (EACH)

**6' Start Up Kit** CCSK-6 (EACH)



CCM-6



CCT-6



CCSS-1



CCSK-6



KCP-1



KCP-1C

Show your team spirit with your school logo



KCPD-2

## KEYCLEAN PRO

- 2 large 18" x 24" mops made with highly absorbent microfiber pads
- 6' adjustable two-piece aluminum handle
- Fast drying and slip resistant to reduce injuries
- 2 mops and 2 pads included
- Replacement pads available
- Can be customized
- 1 Year Limited Warranty



**Keyclean Pro Set** KCP-1 (EACH)  
**Keyclean Pro Pads** KCPD-2 (EACH)  
**Custom Pro Set** KCP-1C (EACH)

Consists of a 6' adjustable two-piece aluminum handle with a heavy-duty attachment to the pad board.







## SCORER TABLE



### Free Standing Style:

- Folds for easy storage
- Heavy-duty steel/aluminum construction
- Integrated power strip and media wire tray
- 8' or 10'L x 3'H x 34"D
- Padding available in 15 colors: Maroon, Print Black, Cardinal Red, Silver Gray, Kelly Green, Navy Blue, Royal Blue, Forest Green, Team Orange, Midnight Blue, Electronic Blue, Teal Blue, Medium Purple, Desert Tan or Golden Yellow (*specify when ordering*)

### Free Standing Style - Rear-Lit

- 8' Long** ST-8FS (EACH)
- 10' Long** ST-10FS (EACH)

### Bleacher Mount Style:

- Folds for easy storage
- Heavy-duty steel/aluminum construction
- Built in 110 volt powder strip
- Integrated power strip and media wire tray
- 8' or 10'L x 3'10"H x 18"D
- Padding available in 15 colors (*See above, specify when ordering*)

Call for freight quote.

### Bleacher Mount Style - Rear-Lit

- 8' Long** ST-8BM (EACH)
- 10' Long** ST-10BM (EACH)

## POSSESSION INDICATOR

- Red LED indicator lights with toggle switch operation
- 15' long AC adapter included
- 20" x 5" x 2"
- 1 Year Limited Warranty

POSIND1 (EACH)

# TITAN™

ADJUSTABLE SERIES

## TITAN™ ADJUSTABLE SERIES



Heavy-duty adjustable steel systems for indoor/outdoor play. A colossal achievement in high performance hoops!

- Adjustable height of 5½' to 10'
- 2" x 4" heavy gauge steel extension arms
- Tempered glass backboards
- Reliable actuator and safety pin-stop
- Duplex coating "hot dip" galvanized with black powder coat finish
- Breakaway rim or flex goal, nylon net, and stainless steel hardware included
- Black pole padding and backboard edge padding included
- 3 Year Limited Warranty: System

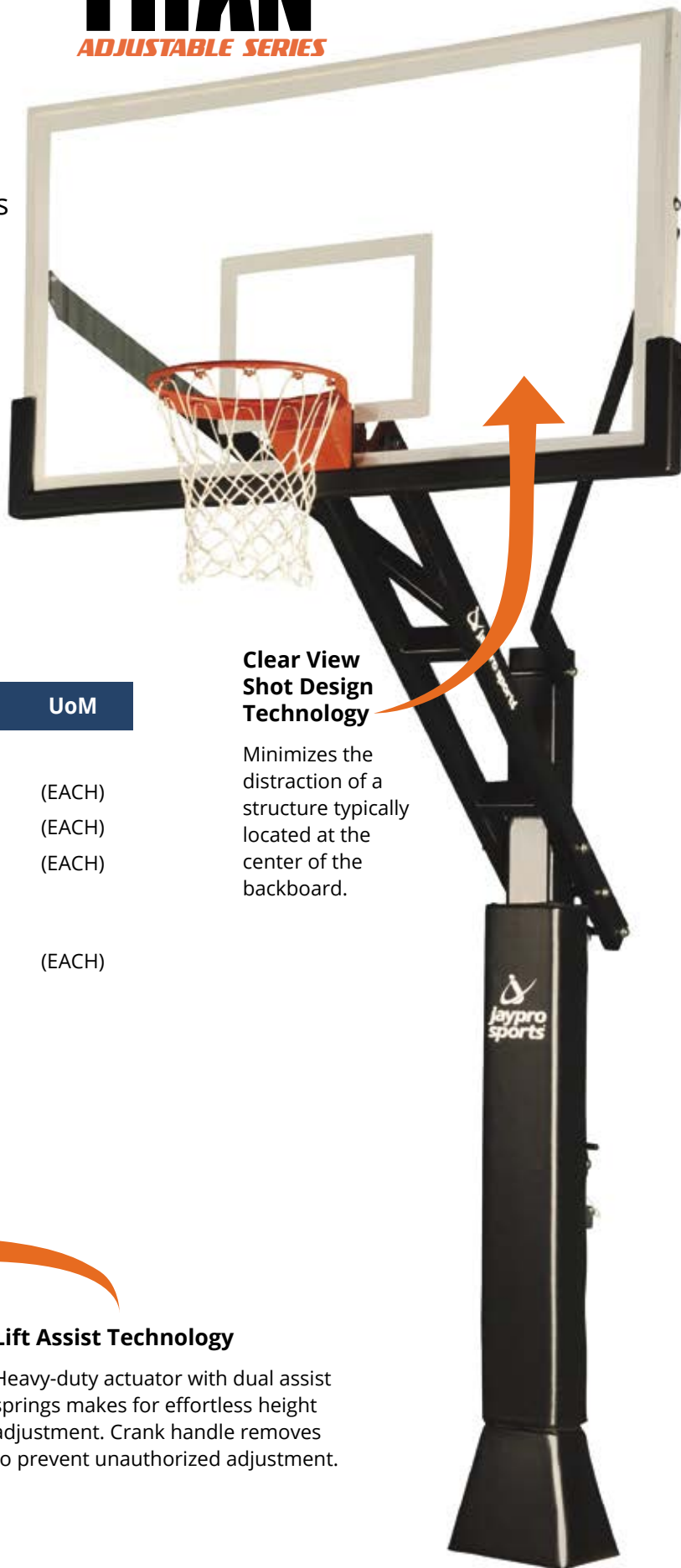

### Clear View Shot Design Technology

Minimizes the distraction of a structure typically located at the center of the backboard.

Item #	Upright	Offset	Backboard	UoM
--------	---------	--------	-----------	-----

#### with Tempered Glass Backboard

CV684A	6" x 8"	4'	42" x 72"	(EACH)
CV664A	6" x 6"	4'	42" x 72"	(EACH)
CV553B	5" x 5"	3'	36" x 60"	(EACH)

#### with Acrylic Backboard

CVAC66	6" x 6"	4'	42" x 72"	(EACH)
--------	---------	----	-----------	--------



### Lift Assist Technology

Heavy-duty actuator with dual assist springs makes for effortless height adjustment. Crank handle removes to prevent unauthorized adjustment.



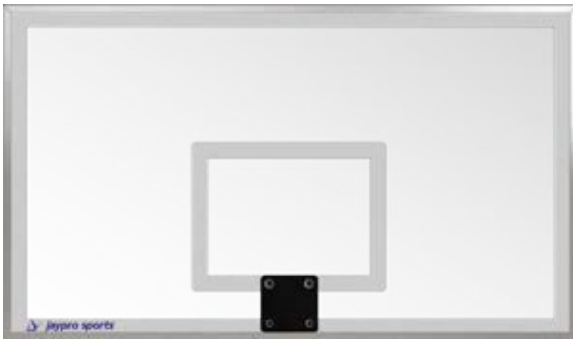

### TITAN™ REPLACEMENT BACKBOARD



- Tempered glass
- Black backboard edge padding included
- 3 Year Limited Warranty

**42" x 72"** GBCV-72 (EACH)  
**36" x 60"** GBCV-60 (EACH)



Black Edge Padding

### TITAN™ REPLACEMENT EDGE PADDING

- 3 Year Limited Warranty

**42" x 72"** CVEP-72 (EACH)  
**36" x 60"** CVEP-60 (EACH)



Breakaway Goal with Nylon Net

### TITAN™ REPLACEMENT GOAL

- 3 Year Limited Warranty

**6" x 8" / 6" x 6"** GBR360 (EACH)  
**5" x 5"** GBR361 (EACH)

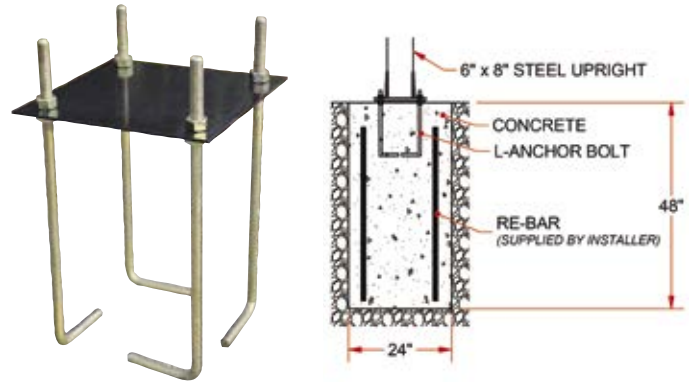

### SURFACE MOUNT ANCHOR KIT

- Kit includes template, J-bolts, rebar, and hardware
- 3 Year Limited Warranty

**6" x 6" and 6" x 8"** CV664A-AF-GJ (EACH)  
**5" x 5"** CV553B-AF-GJ (EACH)

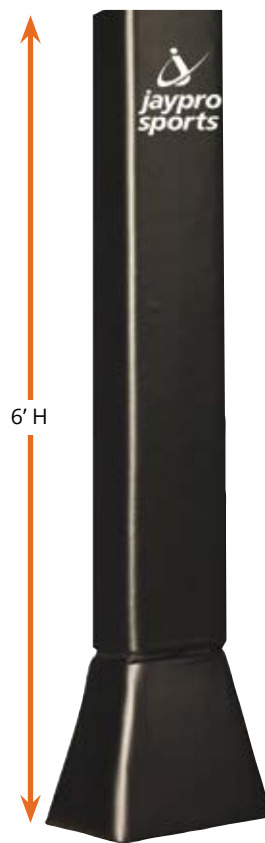

### REPLACEMENT POST AND GUSSET PADDING

- 2" thick square black post padding with gusset padding
- Attaches with hook-and-loop closure
- Available in multiple sizes
- 1 Year Limited Warranty

**6" x 8" with gusset** PP-68 (EACH)  
**6" x 6" with gusset** PP-66 (EACH)  
**5" x 5" with gusset** PP-55 (EACH)  
**4" x 4" with gusset** PP-44 (EACH)

# TITAN™



**Heavy-duty fixed height system with backboard and goal mounted directly to extension arm for exceptional strength. Reinforced with rear support braces!**

**Upright options:** Galvanized or Powder Coated Black

**Backboard options:** Acrylic, Steel, Perforated Steel or Glass

**Goal options:** Playground or Flex Goal

## REPLACEMENT POST PADDING

- 2" thick square black post padding
- Attaches with hook-and-loop closure
- 1 Year Limited Warranty

**6" x 6" pad**  
PP-66T (EACH)



**TITAN™**



- Unit buries 48" into ground
- 6" square steel upright with angled extension arm
- Height can be adjusted after court resurfacing
- Heavy-duty goal and nylon net included
- Backboard - 72"W x 42"H
- 3 Year Limited Warranty: System





# TITAN FIXED SERIES



770-AC-UG  
Acrylic Backboard  
Playground Goal  
Black Post



770-PF-FR  
Perforated Steel Backboard  
Flex Goal  
Black Post



770-RS-UG  
Steel Backboard  
Playground Goal  
Black Post



770-CV-FR  
Glass Backboard  
Flex Goal  
Black Post



Playground Goal

## Black Post with Playground Goal

<b>Acrylic</b>	770-AC-UG (EACH)
<b>Steel</b>	770-RS-UG (EACH)
<b>Perforated Steel</b>	770-PF-UG (EACH)
<b>Glass</b>	770-CV-UG (EACH)



Flex Goal

## Black Post with Flex Goal

<b>Acrylic</b>	770-AC-FR (EACH)
<b>Steel</b>	770-RS-FR (EACH)
<b>Perforated Steel</b>	770-PF-FR (EACH)
<b>Glass</b>	770-CV-FR (EACH)

For more information,  
scan below or go to:  
[www.jaypro.com/Fixed-Height](http://www.jaypro.com/Fixed-Height)



## SERIES ALSO AVAILABLE WITH GALVANIZED POST



Visit us online at [www.jaypro.com](http://www.jaypro.com) or call Customer Service at 800-243-0533 for information and item numbers for the Titan unit with a galvanized post.



Playground Breakaway Goal

## Black Post with Playground Breakaway Goal

<b>Acrylic</b>	770-AC-UB (EACH)
----------------	------------------



## THE CHURCH YARD



Durable fixed height system with black powder coat finish and acrylic or aluminum fan backboard. 40" extension arm for "play safe" area!

- Unit buries 48" into ground
- 4" square steel upright with angled extension arm
- Height can be adjusted after court resurfacing
- Contender Breakaway goal (GBA-548), net (JNY-6HP), post (PP-44) and backboard edge padding\* (EP-48) included
- Acrylic Backboard - 48"W x 36"H
- Aluminum Fan Backboard - 54"W x 36"H
- 3 Year Limited Warranty: System

\*Aluminum fan backboard does not include edge padding.

<b>Acrylic</b>	400-AC-FG (EACH)
<b>Aluminum Fan</b>	400-FA-FG (EACH)







Shown with optional powder coating on pole

For more information,  
scan below or go to:  
[www.Jaypro.com/Gooseneck](http://www.Jaypro.com/Gooseneck)



Rugged all galvanized steel 4½" or 5⅞" Schedule 40 diameter post with direct mount welded to gooseneck for durability and stability. Additionally, two 1⅝ inch diameter steel braces are provided with rectangular backboards. Easy to install and virtually maintenance free. Pole powder coat options available, additional charges apply. See selection chart for backboard and goal combinations.

**POWDER COAT COLORS:** *Black is standard, other powder coat colors should be specified.*





# GOOSENECK SYSTEMS



<b>4½" Diameter Gooseneck Post 4' Offset</b>	Super Goal GBSG-50	Double Rim GDR-54	Playground Goal UBG-500	Flex Goal GBR361	Breakaway Playground UBG-500F
Aluminum Fan ALB-24BT 	996-FABT-SG	996-FABT-DR	996-FABT-UG	996-FABT-FR	996-FABT-UB
Steel 850RB-BB 	996-RS-SG	996-RS-DR	996-RS-UG	996-RS-FR	996-RS-UB
Perforated Steel SR-PERF 	996-PERF-SG	996-PERF-DR	996-PERF-UG	996-PERF-FR	996-PERF-UB
Perforated Alum. AL-PERF 	996-ALP-SG	996-ALP-DR	996-ALP-UG	996-ALP-FR	996-ALP-UB
Acrylic ACRB-72 	996-AC-SG	996-AC-DR	996-AC-UG	996-AC-FR	996-AC-UB

<b>5⅝" Diameter Gooseneck Post 6' Offset</b>	Super Goal GBSG-50	Double Rim GDR-54	Playground Goal UBG-500	Flex Goal GBR361	Breakaway Playground UBG-500F
Aluminum Fan ALB-24BT 	656-FABT-SG	656-FABT-DR	656-FABT-UG	656-FABT-FR	656-FABT-UB
Steel 850RB-BB 	656-RS-SG	656-RS-DR	656-RS-UG	656-RS-FR	656-RS-UB
Perforated Steel SR-PERF 	656-PERF-SG	656-PERF-DR	656-PERF-UG	656-PERF-FR	656-PERF-UB
Perforated Alum. AL-PERF 	656-ALP-SG	656-ALP-DR	656-ALP-UG	656-ALP-FR	656-ALP-UB
Acrylic ACRB-72 	656-AC-SG	656-AC-DR	656-AC-UG	656-AC-FR	656-AC-UB

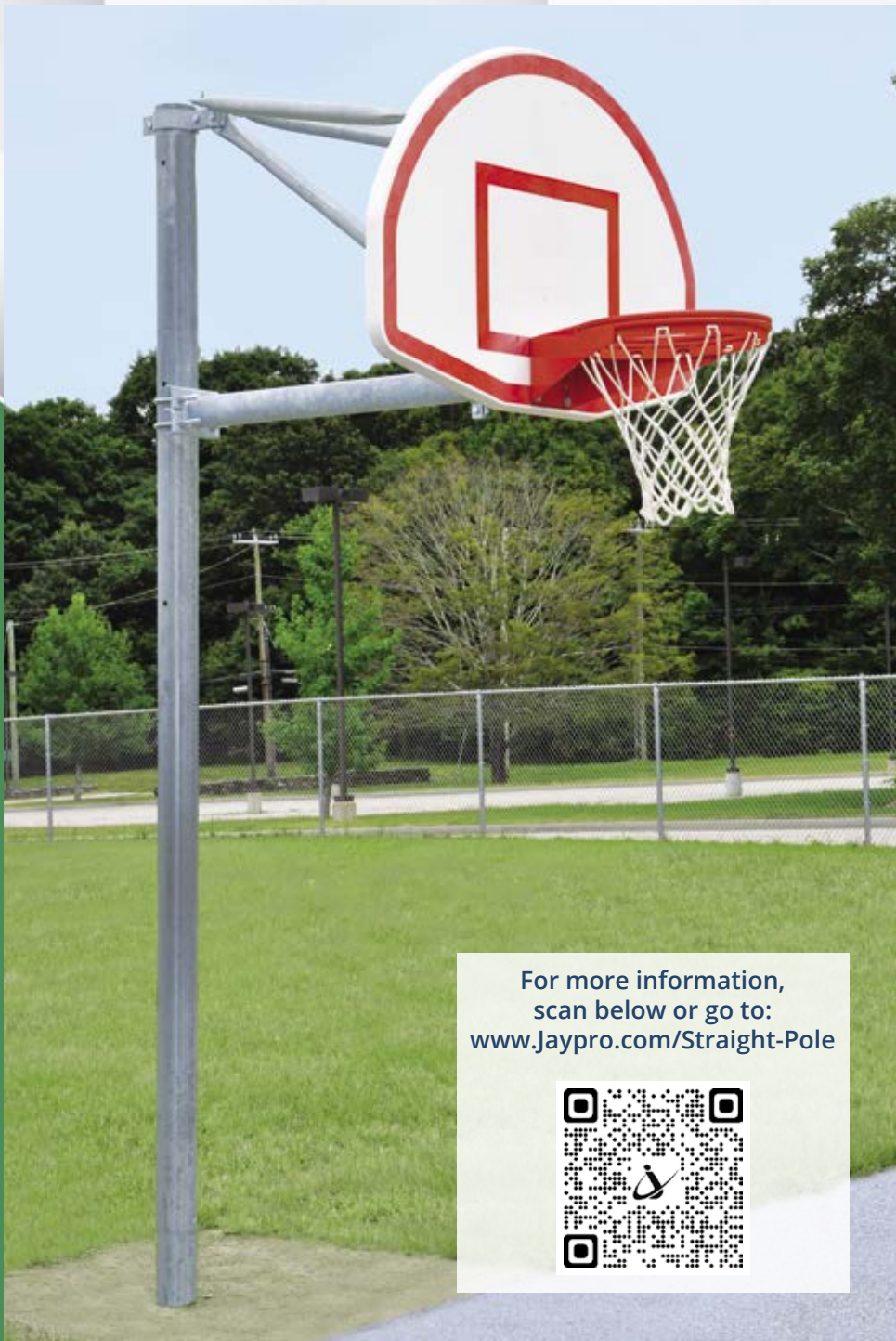

For more information,  
scan below or go to:  
[www.Jaypro.com/Straight-Pole](http://www.Jaypro.com/Straight-Pole)



Easy to install and virtually maintenance free, The out rigger/strut design allows you to set your playing height without compromising strength and stability. Galvanized steel structure is a durable finish. The system is designed for safety, with the 4' outrigger design. Pole powder coat options available, additional charges apply. See selection chart for backboard and board combinations.

**POWDER COAT COLORS:** *Black is standard, other powder coat colors should be specified.*



RED



NAVY  
BLUE



YELLOW



GOLD



GRAY



BLACK



MAROON



DARK  
GREEN



KELLY  
GREEN



ROYAL  
BLUE



WHITE



ORANGE



PURPLE



# STRAIGHT POST SYSTEMS



4½" Diameter Straight Post 4' Offset	Super Goal GBSG-50	Double Rim GDR-54	Playground Goal UBG-500	Flex Goal GBR361	Breakaway Playground UBG-500F
Aluminum Fan ALB-24BT	SPA4-FABT-SG	SPA4-FABT-DR	SPA4-FABT-UG	SPA4-FABT-FR	SPA4-FABT-UB
Steel 850RB-BB	SPA4-RS-SG	SPA4-RS-DR	SPA4-RS-UG	SPA4-RS-FR	SPA4-RS-UB
Perforated Steel SR-PERF	SPA4-PERF-SG	SPA4-PERF-DR	SPA4-PERF-UG	SPA4-PERF-FR	SPA4-PERF-UB
Perforated Alum. AL-PERF	SPA4-ALP-SG	SPA4-ALP-DR	SPA4-ALP-UG	SPA4-ALP-FR	SPA4-ALP-UB
Acrylic ACRB-72	SPA4-AC-SG	SPA4-AC-DR	SPA4-AC-UG	SPA4-AC-FR	SPA4-AC-UB

5⅝" Diameter Straight Post 6' Offset	Super Goal GBSG-50	Double Rim GDR-54	Playground Goal UBG-500	Flex Goal GBR361	Breakaway Playground UBG-500F
Aluminum Fan ALB-24BT	SPA6-FABT-SG	SPA6-FABT-DR	SPA6-FABT-UG	SPA6-FABT-FR	SPA6-FABT-UB
Steel 850RB-BB	SPA6-RS-SG	SPA6-RS-DR	SPA6-RS-UG	SPA6-RS-FR	SPA6-RS-UB
Perforated Steel SR-PERF	SPA6-PERF-SG	SPA6-PERF-DR	SPA6-PERF-UG	SPA6-PERF-FR	SPA6-PERF-UB
Perforated Alum. AL-PERF	SPA6-ALP-SG	SPA6-ALP-DR	SPA6-ALP-UG	SPA6-ALP-FR	SPA6-ALP-UB
Acrylic ACRB-72	SPA6-AC-SG	SPA6-AC-DR	SPA6-AC-UG	SPA6-AC-FR	SPA6-AC-UB

### 3 1/2" GOOSENECK SYSTEM



Direct mount style system with backboard and goal mounted directly to extension arm for exceptional strength. 36" extension arm for "play safe" area!

- 3 1/2" zinc undercoated steel upright
- Galvanized or powder coat finish option
- Aluminum fan backboard (ALB-24BT) , goal (GB-55), and nylon net (JNY-4HP) included
- Backboard - 54"W x 36"H
- 3 Year Limited Warranty: System

**Black** 455-FABT-SR-BK (EACH)

**Galvanized** 455-FABT-SR (EACH)



Black Post



Galvanized Post

### ULTIMATE ADJUSTABLE GOOSENECK



A complete adjustable gooseneck system with the benefits of a Hoop Rejuvenator™ Kit.

- 4 1/2" OD heavy-walled galvanized steel post
- H-frame style with 48" extension for "play safe" area
- Acrylic, rectangular steel and aluminum fan backboard options
- Breakaway goal (UBG-500F), and Hoop Rejuvenator™ Kit included
- 3 Year Limited Warranty: System

**72" x 42" Acrylic Board** UAG-AC (EACH)

**54" x 36" Aluminum Fan Board** UAG-FA (EACH)

**72" x 42" Steel Board** UAG-RC (EACH)



Shown with optional post padding (PPP-500HP)





# HOOP REJUVENATOR™

## HOOP REJUVENATOR™ KIT



Hoop Rejuvenator™ allows for easy upgrading of existing systems without the added cost of excavating and replacing them.

- Plumbs backboards on leaning goosenecks
- Allows for goal height adjustment after court resurfacing (up to 6" for H-frames and 5" for direct mount units)
- Designed to fit standard mount plates and gooseneck systems 4½" OD and up
- Acrylic, rectangular steel, and aluminum fan backboard options
- H-frame kit and direct mount kit models
- Breakaway goal (UBG-500F), stainless steel hardware, and zinc galvanizing spray to cover rust spots included
- 3 Year Limited Warranty: System

*3½" OD goosenecks only use aluminum fan backboard (HRKIT-FA).*



### H-Frame Design:

The H-Frame design is to be used on systems where gooseneck mounts near the center of the backboard, not at the rim, but above it.



### Direct Mount Design:

The Direct Mount design is to be used on systems where both backboard and rim are mounted directly to gooseneck.

	Item #	Backboard	UoM
<b>H-Frame</b>	HRKIT-AC	72" x 42" Acrylic	(EACH)
	HRKIT-FA	54" x 36" Alum. Fan	(EACH)
	HRKIT-RC	72" x 42" Steel	(EACH)
<b>Direct Mount</b>	HRKIT-AC-DIR	72" x 42" Acrylic	(EACH)
	HRKIT-FA-DIR	54" x 36" Alum. Fan	(EACH)
	HRKIT-RC-DIR	72" x 42" Steel	(EACH)



### BASKETBALL POST PADDING



- 6' tall x 30" wide padding with 4" thick high-density foam
- 12½" diameter
- 14 oz. vinyl cover (available in 14 colors) with grommet flaps for rear lacing
- Lacing cord included
- Fits 4½" posts
- 1 Year Limited Warranty

*Specify vinyl color when ordering. Custom graphics not available with this product.*

**4½" OD Pole**    PPP-5HP (EACH)



### PRO STYLE PROTECTOR PAD



- 6' tall pad with minimum of 6" thick cylindrical high-density foam
- 17½" diameter
- 14 oz. nylon reinforced vinyl cover (available in 14 colors) with hook-and-loop closure
- 1 Year Limited Warranty

*Specify vinyl color when ordering. Custom graphics sold separately.*

**4½" OD Pole**    PPP-500HP (EACH)

**5<sup>9</sup>/<sub>16</sub>" OD Pole**    PPP-700HP (EACH)



### PRO STYLE PROTECTOR PAD



- 6' tall pad with minimum of 3¾" thick cylindrical protective safety foam
- 13" diameter
- 14 oz. nylon reinforced vinyl cover (available in 14 colors) with hook-and-loop closure
- 1 Year Limited Warranty

*Specify vinyl color when ordering. Custom graphics sold separately.*

**4½" OD Pole**    PPP-100 (PAIR)  
PPP-100HP (EACH)

**5<sup>9</sup>/<sub>16</sub>" OD Pole**    PPP-300 (PAIR)  
PPP-300HP (EACH)





# Custom Graphics for Basketball Post Padding

Customize basketball post pads with digital graphics.



### BASKETBALL POST PAD DIGITAL GRAPHICS

Customize your post padding.

Contact customer service at 800-243-0533 for artwork requirements. Extended lead time.

**Multi-color** JSG-BPP2 (PER PAD)



### BASKETBALL COURT STENCIL

Easily paint a regulation basketball court on a driveway, patio or play area.

- Precision cut stencils
- Paint roller included
- 13'L x 21'W
- 1 Year Limited Warranty

BCS-1 (EACH)

# GYM DIVIDER CURTAINS

Jaypro Sports offers a variety of functional and attractive divider curtains that help divide any sports facility or institutional space. From power-controlled to manual curtains, we custom design divider curtains for any facility size requirements. Also available in solid vinyl or vinyl coated mesh with several color options.

## FOLD UP CURTAIN FC-680

The most versatile and robust curtain in the industry. This curtain uses hoist cables which are weaved through grommets and are attached to the bottom batten. Hoist cables simply roll on the driveline, causing the curtain to fold neatly towards the ceiling in an accordion style fashion.

- Most durable, longest lasting curtain in the industry
- Easiest retractable curtain to install
- Compact fold to maximize clear height

*Call for freight quote.*

## Electric Curtain Winch CW-1800



*See (page151) for details*

**Visit [JAYPRO.COM](http://JAYPRO.COM) for product specifications**

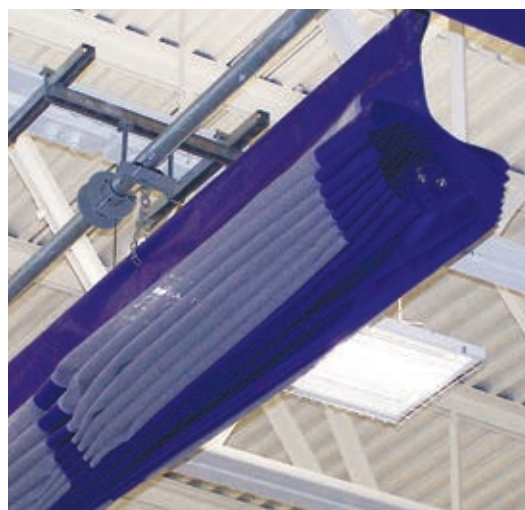
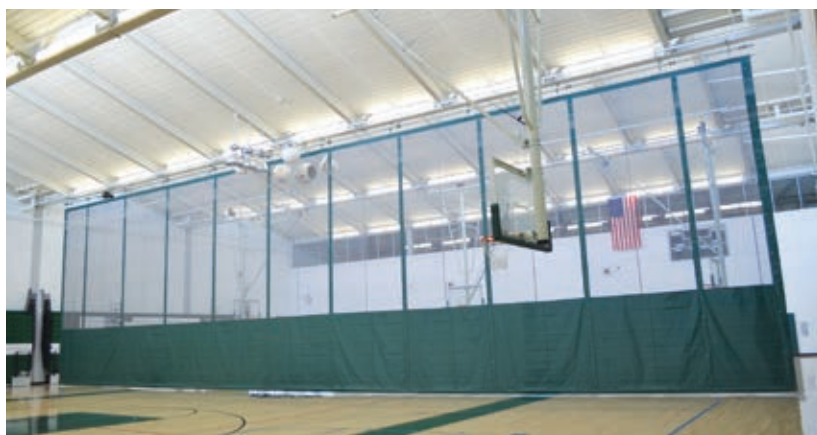



**SLOPE FOLD CURTAIN SC-685**

Engineered to fit against the roof frame and conform to virtually any slope while providing maximum clearance for all sporting activities. This curtain can conform to virtually any roof to maximize clearance for all sporting events. Check out the new Field House Slope Fold Curtain (page 147, SC-685XL). *Call for freight quote.*

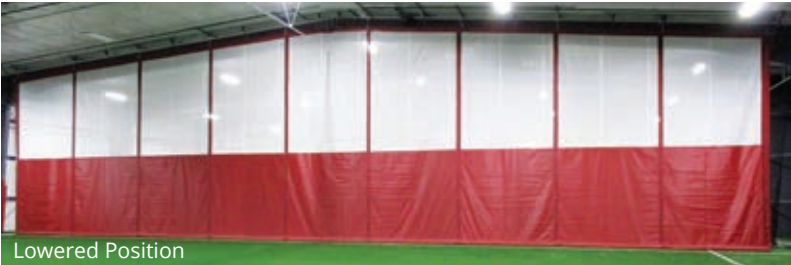

Lowered Position



Raised Position

**WALK DRAW CURTAIN**

WC-660 & WC-660BP

Designed for manual operation, this curtain is moved by pulling it along a ceiling suspended track to store along a perimeter wall. *Call for freight quote.*



**TOP ROLL CURTAIN TC-701**

Uses no hoist cables or straps to raise and lower the curtain and stores tighter than many other curtain designs for additional clearance with low ceilings. When operated, the entire fabric rolls onto the drive pipe. *Call for freight quote.*



**MINI TOP ROLL CURTAIN TC-710**

Compact curtain system designed to store tight to the ceiling structure by means of an internal tubular motor. Ideal for cafeterias, meeting rooms, stages, or other small spaces. *Call for freight quote.*



**ROLL UP CURTAIN RC-690**

Raised and lowered by heavy-duty hoist belts and stores in a 2' storage space close to the building structure. When operated, hoist belts roll the fabric onto the bottom batten. *Call for freight quote.*





**CENTER DRIVE CURTAIN CDC-800**

Ceiling suspended center drive divider curtain is available in solid vinyl lower with mesh upper or all solid vinyl or all mesh. The top and bottom panels roll into the center of the curtain. This design allows the center roll up curtain to stow twice as fast as full suspended curtains. The curtain rolls into a small round tube that stows away for maximum clearance. *Call for freight quote.*

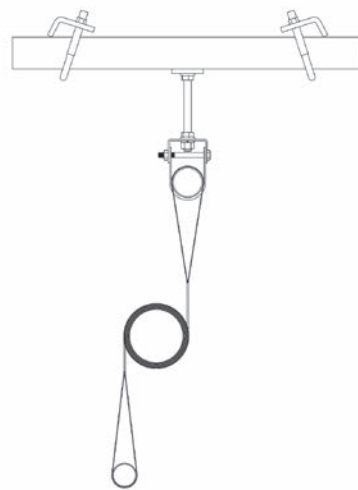

Visit [JAYPRO.COM](http://JAYPRO.COM) for product specifications



**FIELD HOUSE SLOPE FOLD CURTAIN SC-685XL**

Engineered to fit against the roof frame and conform to virtually any slope while providing maximum clearance for all sporting activities. This mega curtain utilizes dual synchronized winches with a low voltage controller. This curtain can conform to virtually any roof to maximize clearance for all sporting events. Pictured below, this SC-685XL curtain measures 190' long and 42' high at the peak and raises to the ceiling in 75 seconds. *Call for freight quote.*

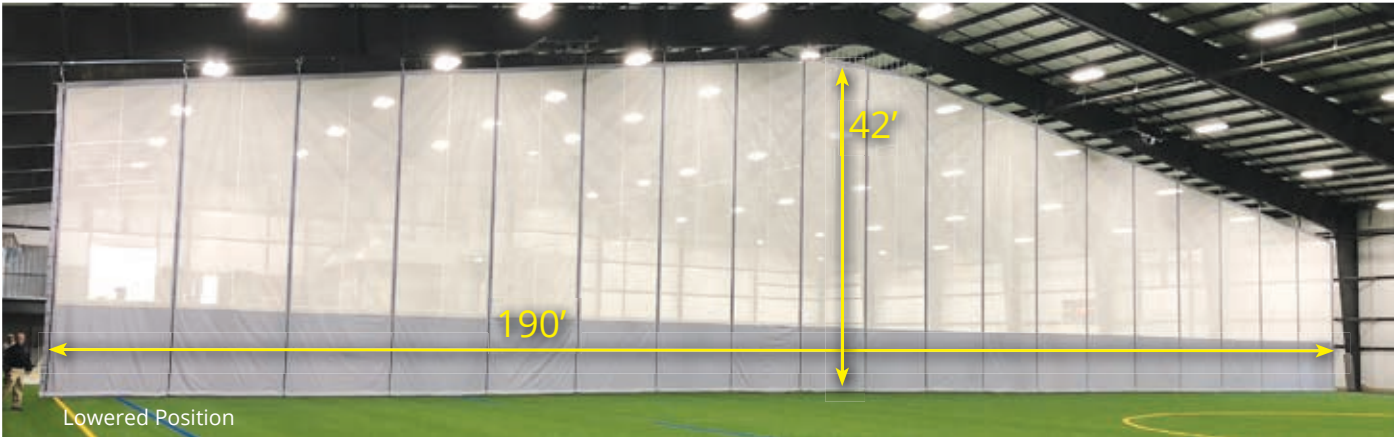

**PERIMETER FOLD UP CURTAIN FC-680P**

Jaypro Perimeter Curtains are ideal for completely following the inside or outside perimeter of running tracks within multi-use facilities and field houses. These curtains are designed to separate the running track from interior basketball or volleyball courts, thereby maximizing facility use and flexibility. Adjoining curtains are overlapped and offset to allow for easy egress. *Call for freight quote.*







### MOTORIZED NETTING

Safety netting systems are designed to protect spectators or create safe passageways outside the field of play. A complete surround netting system can be used to seal off a court or field for ball containment. Netting can enclose the perimeter of a facility as well as create a ceiling. Netting systems can be motorized or stationary. Contact Jaypro's estimating department to help design a solution for your netting needs. *Call for freight quote.*

**Visit [JAYPRO.COM](http://JAYPRO.COM) for product specifications**



### PROTECTIVE STATIONARY NETTING

Jaypro makes nets to separate outdoor athletic fields in large complexes and to divide indoor athletic facilities. We also provide complete perimeter and ceiling netting protection for your athletic facility. Our netting is found on tennis courts, basketball courts, soccer fields, and golf courses. Everything we make is customized to your needs as no two facilities are alike. Call or e-mail us to discuss your project. *Call for freight quote.*

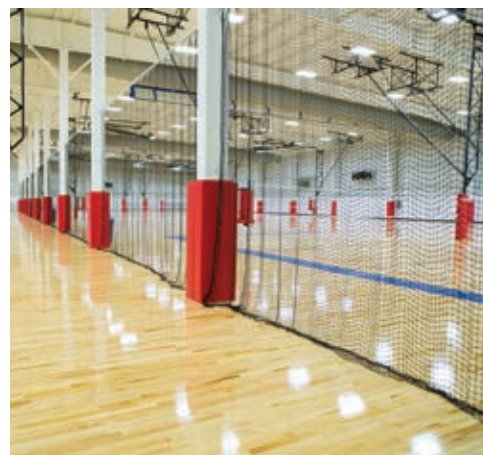



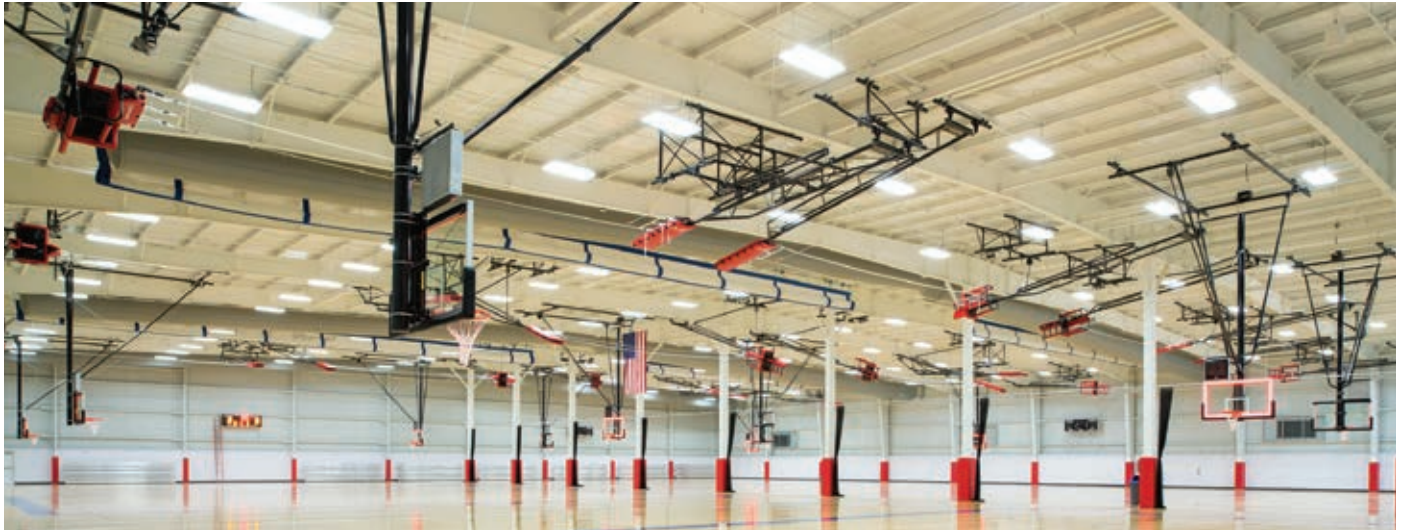

*Cape Girardeau SportsPlex, Cape Girardeau, MO  
Jaypro Sports - Winner of the American Sports Builders Association award for Multi-Purpose Field House Facility of the Year (2017)*

## MASTER EQUIPMENT CONTROLLER 2

The MEC2 control system is similar to your touch screen smartphone, with a slick wall mounted touch screen that allows grouped operation of up to eight devices. The MEC2 includes intuitive menus to allow anyone to easily program at any point in time, without switches or removal of the screen. The MEC2 control system is ideal for grade schools or facilities with 6 or more retractable devices. Also, the MEC2 can also be easily retrofitted into existing facilities that may have an outdated numbered touch pad or existing key switches. Simply put, the MEC2 is the leading economical equipment control system in the industry!

- Low voltage 7" capacitive touchscreen
- Individual or grouped simultaneous operation
- Easily expandable w/ low cost expansion relay boards
- Protected with multiple tiered access logins
- Simple retrofit from existing methods of operation
- Direct replacement for MEC-99 control system
- Refer to the MEC2 spec sheet for additional information

MEC2 (SYS)



**For more information:  
Visit [meta-sports.world](http://meta-sports.world)**

## EASY TOUCH EQUIPMENT CONTROLLER

The ETEC control system is designed for large and small sports facilities that require the ultimate control of the retractable equipment. With a single push of a button, the operator can simultaneously raise multiple devices while lowering several others from the 10" touch screen. The ETEC control system is highly recommended for pay-to-play facilities where quick sport turnover is critical, allowing multiple basketball courts to be converted to volleyball courts in a few quick minutes. This system includes a custom designed graphical interface with your facility logos and colors.

- Low voltage 10.4" high resolution LCD touchscreen
- Simultaneous up and down operation
- On-the-fly quick selection programming
- Customized facility layouts with intuitive graphical interface
- Instantly saves user programs with the press of a button
- Refer to the ETEC spec sheet for additional information

ETEC (SYS)



"Intent" safety key pad requires constant touch control for system operations.

# BACKSTOP WINCHES



## ELECTRIC TORK WINCH

<b>Winch Only</b>	TW-2000-1 (EACH)
<b>Winch &amp; Key Switch</b>	TW-2000 (EACH)
<b>Winch, Key Switch &amp; Wood Kit</b>	TW-2000KT1 (EACH)



## ELECTRIC LYNRUS WINCH

<b>Winch Only</b>	SBBW-4-1 (EACH)
<b>Winch &amp; Key Switch</b>	SBBW-4 (EACH)
<b>Winch, Key Switch &amp; Wood Kit</b>	SBBW-4KT1 (EACH)



## TORK WINCH SAFETY STRAP

<b>Strap Only</b>	PL-1000 (EACH)
<b>Strap &amp; Wood Kit</b>	PL-1000KT1 (EACH)



## AUT-O-LOC2 SAFETY STRAP

<b>Strap Only</b>	SBAL-30 (EACH)
<b>Strap &amp; Wood Kit</b>	SBAL-30KT1 (EACH)

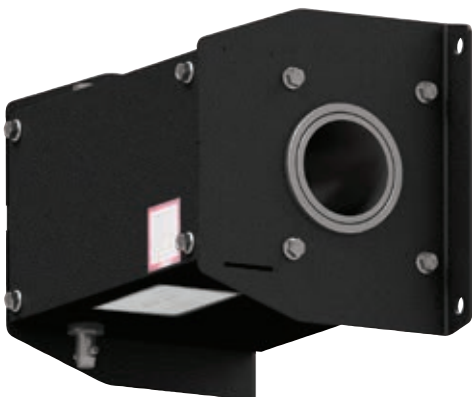

## MANUAL TORK WINCH

<b>Winch Only</b>	TW-700M (EACH)
<b>Winch &amp; Wood Kit</b>	TW-700MKT1 (EACH)
<b>Winch Handle</b>	TW700H (EACH)
<b>Winch Drill Operator</b>	ED-902 (EACH)



# CURTAIN & BATTING CAGE WINCHES

## ELECTRIC TORK WINCH

- Winch Only CW-1800-1 (EACH)
- Winch & Key Switch CW-1800 (EACH)



## ELECTRIC LYNRUS WINCH



- Winch Only SBCW-3-1 (EACH)
- Winch & Key Switch SBCW-3 (EACH)
- High Speed Winch Only SBCW-5-1 (EACH)
- High Speed Winch & Key Switch SBCW-5 (EACH)
- 2 3/8" OD Drive Adapter SBCW-3DPA (EACH)



**TORK WINCH CURTAIN LOCK**  
CL-1000 (EACH)

## LYNRUS CURTAIN LOCK

SBCL (EACH)



## HEAVY-DUTY TORK CURTAIN WINCHES

VFD controlled high speed winches for large curtain or batting cage applications.  
*Call for additional details.*

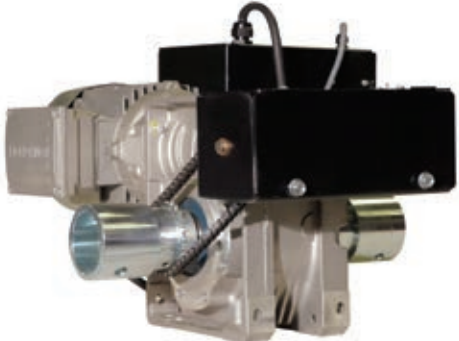
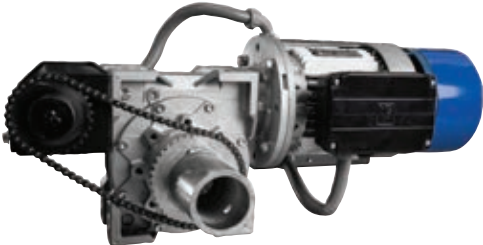

# METHODS OF OPERATION



Ganged Key Switches



Radio Remote Receiver



Radio Remote Transmitter



Key Switch

**Tork Winch Key Switch**

KS-13 (EACH)

**Lynrus Key Switch**

KS-23 (EACH)

**Ganged Key Switches**

XGPWKS (CALL)  
("X" = # of Keys)

**Radio Remote Receiver**

DRX-1199 (EACH)

**Radio Remote Transmitter**

TMX-1199 (EACH)



## ELECTRICAL QUICK DISCONNECT

Winch twist-lock pig tail kit

PT-72 (EACH)



## MANUAL WINCH DRILL OPERATOR

- 1 Year Limited Warranty

ED-902 (EACH)

## MASTER EQUIPMENT CONTROLLER 2

Refer to (page 149) for information and details on these controllers.



MEC2 (SYS)

## EASY TOUCH EQUIPMENT CONTROLLER



ETEC (SYS)



# SECURELIFT™ WRESTLING MAT STORAGE SYSTEMS



Eliminate risk of injury to students, athletes and coaches from manual lifting and transporting of heavy and awkward mats. Gain valuable storage space and extend the life of your wrestling mats. Simply roll the mat(s) onto the sling, attach the sling to the load bar, turn the key to raise the unit and store at ceiling height. 3 Year Limited Warranty. *Call for details and pricing.*



**Ceiling Suspended Single Mat Securelift™**

MH-S-A (CALL)

**Wall-Mounted Single Mat Securelift™**

MHWM-S-A (CALL)



**Ceiling Suspended Double Mat Securelift™**

MH-D-A (CALL)

**Wall-Mounted Double Mat Securelift™**

MHWM-D-A (CALL)



## MATLOK™

### MATLOK™ WRESTLING MAT STORAGE SYSTEM SAFETY STRAP

- Designed to automatically lock a mat hoist system in position should a malfunction occur
- Self-checking, self-leveling, fail safe mechanism features
- System comprised of 2 load bar rocker assemblies and 4 Posilok™ Safety Straps



- System adaptable to any wrestling mat storage system
- Versatile mounting clamps included
- 3 Year Limited Warranty

MH-MLS (CALL)

**Note:** Due to difference in wall construction, Jaypro Sports does not provide anchors or mounting hardware to attach the wall stringers to gymnasium walls. Consult your architect or contractor to determine the best and safest installation methods for your facility.

## WALL-MOUNTED GYM LADDER



- Steel frame with welded supports for strength and durability
- Powder coated black finish is textured for safety
- Inner braces provide stability for lateral movement
- Ladder is attached with wood stringers (included) and is additionally supported with a heavy-duty chain
- Frame extends 48" from wall
- 12'L x 18"W
- 3 Year Limited Warranty

WML-100 (EACH)

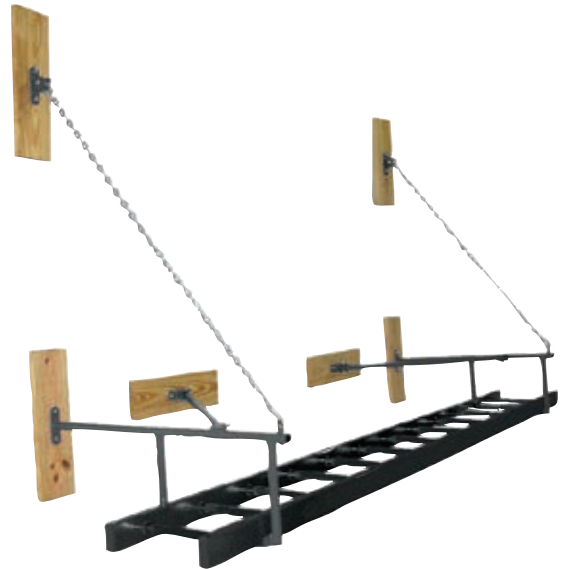

## VERTICAL CLIMBING LADDER



- 1<sup>5</sup>/<sub>16</sub>" steel tubing construction
- Powder coated black finish is textured for safety
- Heavy-duty wall mounting plates
- 60"L x 22"W
- 3 Year Limited Warranty

WVL-7 (EACH)



## WALL GRID CLIMBER



- 1<sup>5</sup>/<sub>16</sub>" steel tubing construction
- Powder coated black finish is textured for safety
- Grid is 4 x 5 rows with 6" pattern
- Heavy-duty wall mounting plates
- 3 Year Limited Warranty

WGC-20 (EACH)



## ADJUSTABLE WALL-MOUNTED CHINNING BAR

- Provides 2' of height adjustment in 6" increments
- All-welded 30" wide steel frame with black powder coat finish
- 3 Year Limited Warranty

EWM-30 (EACH)



## JUMP ROPE RACK

- Wall-mounted all steel construction with powder coat finish
- 27" long with (5) 10" long pegs
- 3 Year Limited Warranty

PE-110 (EACH)



**FOR DETAILS AND PRICING VISIT  
WWW.JAYPRO.COM**





# Let Jaypro help with your facility needs

**Pads that offer player protection to meet your facilities needs. Keep your atmosphere and playing area as safe and comfortable as possible.**

1. Provides excellent wall protection to absorb player impact
2. Reduces noise levels in any facility
3. Wall padding should be installed on all rigid surfaces located in close proximity (within 10') to active playing areas



**VINYL PAD COLORS:** *Specify pad color when ordering*



**Mounting options:**

Lip top and bottom

Z-clip top and lip bottom

Z-clip top and bottom



**Custom Wall Pad Project?  
Call for a Quote!**

**Visit [JAYPRO.COM](http://JAYPRO.COM) for product specifications**

**WallGuard**   
**IMPACT RATED**

- 2" thick high impact foam with 7/16" Oriented Strand Board backing
- 14 oz. fire-retardant vinyl in a variety of colors
- Exceeds impact standards as defined in ASTM F2440-04

Call for freight quote.

Item #	Size	Description	UoM
JWP-I-26	2' x 6'	lip top & bottom	(EACH)
JWP-I-26Z	2' x 6'	z-clip top & lip bottom	(EACH)
JWP-I-26ZZ	2' x 6'	z-clip top & bottom	(EACH)



**WallGuard**   
**FIRE RATED**

- 2" thick high impact foam with 7/16" Oriented Strand Board backing
- 14 oz. fire-retardant vinyl in a variety of colors
- Certified class A fire rating in accordance with NFPA 255/ASTM E-84

Call for freight quote.

Item #	Size	Description	UoM
JWP-A-26	2' x 6'	lip top & bottom	(EACH)
JWP-A-26Z	2' x 6'	z-clip top & lip bottom	(EACH)
JWP-A-26ZZ	2' x 6'	z-clip top & bottom	(EACH)



**WallGuard**   
**FIRE/IMPACT RATED**

- 2" thick fire-retardant and high impact foam with 7/16" Oriented Strand Board backing
- 14 oz. fire-retardant vinyl in a variety of colors
- Exceeds impact standards as defined in ASTM F2440-04
- Certified class A fire rating in accordance with NFPA 255/ASTM E-84

Call for freight quote.

Item #	Size	Description	UoM
JWP-AI-26	2' x 6'	lip top & bottom	(EACH)
JWP-AI-26Z	2' x 6'	z-clip top & lip bottom	(EACH)
JWP-AI-26ZZ	2' x 6'	z-clip top & bottom	(EACH)

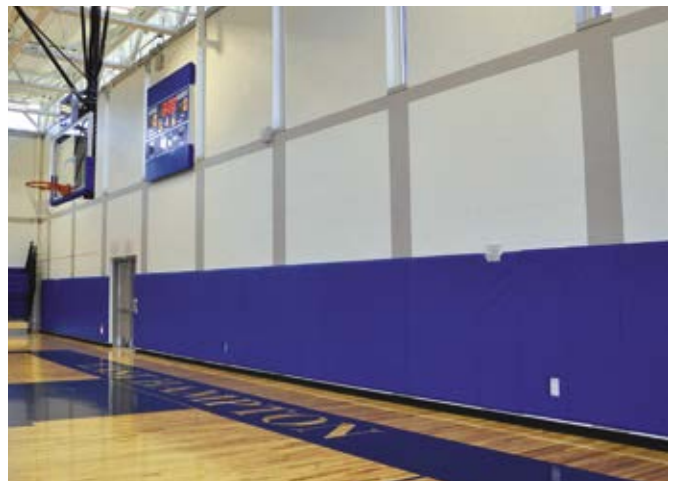



# CUSTOM SIZE PADDING FOR INDOOR FACILITIES

Jaypro Sports offers a variety of custom size padding for your indoor facility. L-shaped corners, I-Beam wraps and Column padding for both straight and tapered columns. Vinyl is available in 14 standard colors.



## L-SHAPED CORNERS



Ideal for a setting where any exposed obstruction must be completely covered on all sides. Found in indoor facilities.

- Fire retardant vinyl
- High impact foam
- Variety of attachment methods

*Specify pad color when ordering. Call for pricing, details, and freight quote.*

VINYL PAD COLORS: *Specify pad color when ordering*



## I-BEAM WRAP



Protect exposed I-beams. Designed to wrap the face and front edges of the beam.

- Fire retardant vinyl
- High impact foam
- Hook-and-loop attachment

*Specify pad color when ordering. Call for pricing, details, and freight quote.*



## COLUMN PADDING



Protect exposed straight or tapered columns commonly found in indoor facilities.

- Fire retardant vinyl
- High impact foam
- Variety of attachment methods

*Specify pad color when ordering. Call for pricing, details, and freight quote.*

# CUSTOM SIZE PADDING FOR INDOOR FACILITIES



## STAGE PADDING



Pads designed specifically for stage applications.

*Specify pad color when ordering. Call for pricing, details, and freight quote.*

- Folding design permits easy storage access
- High impact foam with fire retardant vinyl
- Variety of attachment methods

### VINYL PAD COLORS:



## WALL PAD GRAPHICS

Customize your gymnasium with your team logo or school graphics. Contact customer service at 800-243-0533 for Custom Graphics information and Pricing.







## DUAL PURPOSE WALL/TUMBLING MAT



Serves as wall padding or as a tumbling mats.

- 4' x 6' non-folding mat with 4 handles
- 2" thick vinyl covered foam pad
- 1½" wide hook-and-loop closures on all sides
- 1 Year Limited Warranty

*Specify pad color when ordering.*

GMVH-1 (EACH)



## HOOK-AND-LOOP CLOSURE WALL HANGING STRIP



For use with Dual Purpose Wall/Tumbling Mat (GMVH-1).

- 2" wide aluminum strip
- Pressure sensitive 1½" wide hook-and-loop closure securely bonds to aluminum strip for long lasting use
- Only available in 4' sections
- 1 Year Limited Warranty

VMH-13 (EACH)

## GYM GUARD FLOOR COVER



Protect gymnasium floor during non-athletic events with durable, flame-retardant and fungal resistant fabric.

- Meets Fire Marshall specifications, and ASTM E-84, Class A specs
- 6"-12" overlap recommended
- 18, 22, and 27 oz. options
- 1 Year Limited Warranty

*10' wide standard size. 18 oz. only available in solid colors. Specify dimensions and fabric color when ordering. Call for freight quote.*

- 18 oz Floor Cover** GGFPS-16 (SQ FT)
- 22 oz Floor Cover** GGFPS-22 (SQ FT)
- 27 oz Floor Cover** GGFPS-24 (SQ FT)



**18 oz. Color Options:** Tan, Royal Blue, Light Gray, Red, Dark Green, Burgundy, Light Green, Navy Blue, Black, Orange, Yellow and Purple.

**22 oz. Color Options:** Tan, Brown/Tan, Royal Blue, Tan/Royal Blue, Light Gray, Red, Kelly Green, Burgundy, Navy Blue, Black and Yellow.

**27 oz. Color Options:** Tan, Brown/Tan, Royal Blue, Tan/Royal Blue, Red, Kelly Green, Burgundy, Navy Blue, Dark Gray and Black.

## FLOOR COVER STORAGE RACK



- All steel construction
  - 8" dia. non-marking wheels lock and swivel
  - 2 hand cranks included
  - 1 Year Limited Warranty
- Call for freight quote.*

- 6 Roll Rack** MSR-6 (EACH)
- 8 Roll Rack** MSR-8 (EACH)
- 10 Roll Rack** MSR-10 (EACH)



MSR-8

## SHIPPING NOTICE

Extended forklift or loading dock required to unload the safety storage racks.

**FACILITY  
SCOREBOARDS  
FOR:**

**BASKETBALL**

**VOLLEYBALL**

**WRESTLING**

**BASEBALL**

**SOFTBALL**

**FOOTBALL**

**SOCCER**

**LACROSSE**

Call Customer Service for the purchase of Scoreboards and Console Controllers.







## SHOT AND PLAY CLOCK

- Lighter, thinner, stronger
- Built-in horn
- Comes in black
- Double sided version also available
- Digits are 13"
- 20"H x 20"W x 2"D
- Used with NEVCO scoreboards

Call for freight quote.

BKS29 (PAIR)

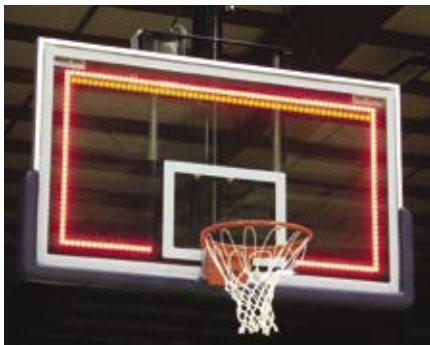

## LED BACKBOARD LIGHT KIT

- Backboard lights up when shot clock or game time reaches zero
- Used with NEVCO scoreboards

Specify manufacturer/model when ordering. Interfaces with most shot clocks. Call for information and freight quote.

BB-LED42 (KIT)

## TABLETOP SCOREBOARD

Rear control panel with visual display.

- LED lights score up to 199 and timer up/down to 99:59
- Automatic/manual buzzer
- 110v power with 15' power cord
- Size: 16" x 24" x 10"
- 3 Year Limited Warranty

TTS10 (EACH)



Digital display control panel on back for operator



# GymGlide™



## GYMGLIDE™ RECREATIONAL GAME STANDARD



Upright with retractable front swivel wheels for easy mobility. Never tip to move or store!

- 155 lb. cast-iron base
- Holding capacity equivalent to 220 lb. game standard
- Adjustable height collars
- 3 Year Limited Warranty

*Specify base color when ordering.*

**Royal Blue**  
GG-100RB (EACH)

**Red**  
GG-100RD (EACH)

**GymGlide™ base color options:**



Rotate the handle for a safe and easy way to move the standard.

## GYMGLIDE™ PACKAGE #1



Package Includes:

- 2 GymGlide™ Game Standards (GG-100XX)
- 2 GymGlide™ Economy Upright Pads (GG-UPAD)
- 1 Volleyball Net (VBN-32)
- 3 Year Limited Warranty: Standards

GG-100PKG (PKG)

*Specify pad & base color when ordering.*

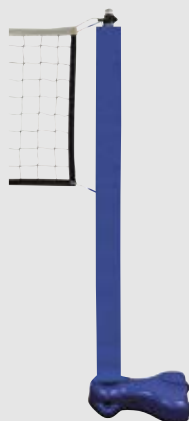

## GYMGLIDE™ PACKAGE #2



Package Includes:

- 2 GymGlide™ Game Standards (GG-100XX)
- 2 GymGlide™ Base Pads (GG-BPAD)
- 2 Official Standard Pads (PVB60PHP)
- 1 Volleyball Net (VBN-32)
- 3 Year Limited Warranty: Standards

GG-100PKGD (PKG)

*Specify base & pad colors when ordering. Custom graphics available on pads at additional cost.*

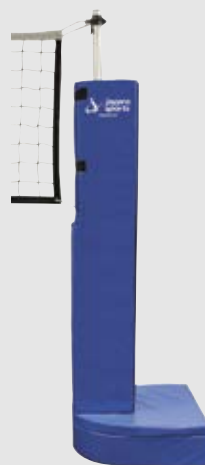

GG-UPAD

## P.E. ECONOMY UPRIGHT PAD

- 6' tall x 1" thick foam pad with vinyl cover
- Attaches to upright with hook-and-loop straps
- 1 Year Limited Warranty

GG-UPAD (EACH)



## GYMGLIDE™ BASE PAD

- Designed for GymGlide™ game standard base
- 2" thick foam pad with vinyl cover
- 1 Year Limited Warranty

GG-BPAD (EACH)



**VINYL PAD COLORS:** *Specify pad color when ordering*





## MULTI-PURPOSE GAME STANDARDS



Versatile game standards with sliding height adjustment collars. Available in three weights (75 lbs., 145 lbs., and 220 lbs.)!

- 10' tall x 2" uprights
- 24" dia. steel bases with rubber rims protects floor
- Tip-and-roll transport on non-marking wheels
- Nets sold separately
- 3 Year Limited Warranty

*EXCLUSIVE: Upright hub on base includes tethered safety bolt and two stabilizer jacking screws for an extra margin of safety.*



Easily adjust net height with sliding collars

Game Standard base color options:



Size in lbs	Item #	Color	UoM
-------------	--------	-------	-----

### 75 lb. Base - (Two-piece pole)

75	AS-475R	Royal Blue	(PAIR)
75	AS-475RR	Red	(PAIR)

### 145 lb. Base - (Two-piece pole)

145	MP-500R	Royal Blue	(PAIR)
145	MP-500RG	Green	(PAIR)
145	MP-500RR	Red	(PAIR)
145	MPC-5145R	Royal Blue	(EACH)

### 220 lb. Base - (One-piece pole)

220	MP-521R	Royal Blue	(PAIR)
220	MP-521RR	RED	(PAIR)
220	MPC-5211R	Royal Blue	(EACH)



## ECONOMY TENNIS STANDARDS



Indoor/outdoor galvanized steel standards.

- 44" tall x 2" uprights
- 145 lb. rubber trimmed roll-a-way bases
- Net sold separately
- 3 Year Limited Warranty

JT-175R (PAIR)



## BASE PAD

- Designed for 24" dia. game standard
- 2" thick foam pad with vinyl cover
- 1 Year Limited Warranty

**Royal Blue** PBC-24RB (EACH)

**Red** PBC-24RD (EACH)



### DELUXE GAME STANDARDS

Deluxe standards with net tensioning ratchet. Tip-and-roll transport on non-marking wheels!

- 8' tall x 2 3/8" galvanized steel uprights
- 24" dia. steel bases with hand knobs and guy wires for anchoring
- 2 floor anchors required per system and sold separately
- 3 Year Limited Warranty

SS-320R (PAIR)

### DELUXE CENTER STANDARD

Upright compatible with Deluxe Game Standard (SS-320R) for a two-court set up.

- 2 floor anchors required per center standard and sold separately
- 3 Year Limited Warranty

SSC-321R (EACH)

*See (page 21) for information on floor anchors.*



### VOLLEYBALL NET

- Rope Cable
- 32'L x 36"H
- 1 Year Limited Warranty

VBN-32 (EACH)



### BADMINTON NET

- Rope Cable
- 21'L x 30"H
- 1 Year Limited Warranty

BND-1 (EACH)



### TENNIS NET

- Rope Cable
- 42'L x 42"H
- 1 Year Limited Warranty

TDP-42 (EACH)



### INDOOR TENNIS NET

- Compatible with standard volleyball sleeve spacing
- 36'L x 42"H
- 1 Year Limited Warranty

TPV-13 (EACH)



Portable

### SEMI-PERMANENT OUTDOOR TETHERBALL POLE



- 2" galvanized (2-piece) steel upright is 9' tall (installed)
- 18" ground sleeves with top cap included
- 3 Year Limited Warranty

**without Ball** TBP-200 (EACH)

**with Ball** TBP-200PKG (PKG)

### HEAVY-DUTY PERMANENT TETHERBALL POLE



- 2 3/8" galvanized (2-piece) steel upright is 10 1/2' tall (installed)
- Comes with cap and leader chain
- 3 Year Limited Warranty

**without Ball** TBP-250 (EACH)

**with Ball** TBP-250PKG (PKG)

### PORTABLE TETHERBALL POLE



Indoor/outdoor unit with pre-assembled leader chain. Tip-and-roll transport on non-marking wheels!

- 2" galvanized (2-piece) steel upright is 10' tall
- 24" dia. steel base with protective rubber trim
- Tetherball (TBP-BALL) sold separately
- 3 Year Limited Warranty

TBP-275R (EACH)

### TETHERBALL

- Ultra-cushioned, sponge rubber construction
- Recessed rope holder and nylon rope included
- 3 Year Limited Warranty



TBP-BALL (EACH)



# EASY PLAY STANDARDS

Tip-and-roll game standards ideal for a variety of indoor/outdoor sports.

## EASY PLAY MULTI-PURPOSE STANDARD

Multi-sport standard with sliding height adjustment collars.

- 6 $\frac{5}{8}$ " dia. steel T-bases with non-marking wheels
- 10' tall x 2" galvanized steel upright (two piece)
- Systems (includes 2 bases & posts) or post only models available
- Recreation net options only (VBN-32, BND-1 and TDP-42) sold separately
- Base - 40"W x 32"D
- 3 Year Limited Warranty

*Bases filled with 55 lbs. (minimum) of customer supplied ballast.  
Easy Play Game Standards are not designed to achieve competition net tension.*

<b>Game Standard &amp; Pole</b>	EZ-55 (PAIR)
<b>Volleyball Net</b>	VBN-32 (EACH)
<b>Badminton Net</b>	BND-1 (EACH)
<b>Tennis Net</b>	TDP-42 (EACH)



## EASY PLAY BADMINTON

Easily setup a portable (61"H) badminton court.

- 6 $\frac{5}{8}$ " dia. steel T-bases (40"W x 32"D) with non-marking wheels
- 1 $\frac{7}{8}$ " steel post(s) with white powder coat finish
- Clamcleats® included for securing net cords

<b>Std. &amp; Post</b>	EZBSO-3 (PAIR)
<b>Badminton Net</b>	BND-1 (EACH)
<b>Posts Only</b>	EZBP (PAIR)

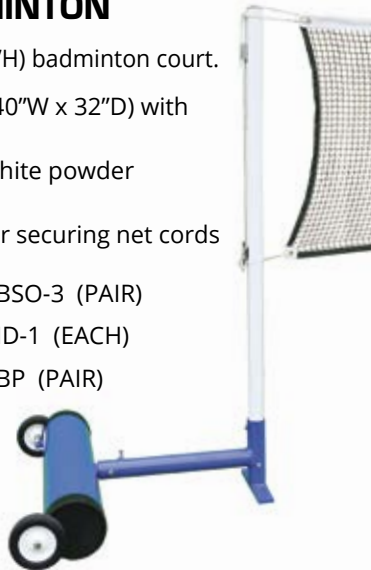

## ELEMENTARY BASKETBALL ADAPTER

- 7' max goal height for indoor use only
- Fits any 2" game standard upright
- Goal (G-35), net (JNY-4HP), and mounting hardware included
- 3 Year Limited Warranty

EZBB-8 (EACH)



## EASY PLAY TENNIS

Easily setup a portable (42"H) tennis court.

- 6 $\frac{5}{8}$ " dia. steel T-bases (40"W x 32"D) with non-marking wheels
- 2 $\frac{3}{8}$ " steel post(s) with black powder coat finish
- Recommended net (TDP-42) sold separately



<b>Standard &amp; Post</b>	EZTBP-5 (PAIR)
<b>Tennis Net</b>	TDP-42 (EACH)
<b>Posts Only</b>	EZTP (PAIR)

## NET BALL ADAPTER

- Fits any 2" game standard upright
- Goal (G-35), net (JNY-4HP), and mounting hardware included
- 3 Year Limited Warranty

EZNB-10 (EACH)





### DELUXE FLOOR HOCKEY GOALS

Lightweight goals with rubber feet protect gymnasium floors.

- 1<sup>5</sup>/<sub>16</sub>" galvanized steel frames with cast aluminum corner fittings
- Polyethylene nets with colored sleeves (1 red and 1 blue) included
- Replacement nets (FHN-36) available
- Dimensions: 4'H x 6'W x 20"D
- 3 Year Limited Warranty: Goal

<b>Goal</b>	FHGN-33 (PAIR)
<b>Replacement Nets</b>	FHN-36 (PAIR)



### FOLDING MULTI-PURPOSE GOALS

Durable goals for quick indoor/outdoor games.

- 1<sup>5</sup>/<sub>16</sub>" steel frames fold and roll for convenient storage
- Knotless nets with colored sleeves (1 red and 1 blue) included
- Dimensions: 4'H x 6'W
- 3 Year Limited Warranty: Goal

<b>Goals</b>	FHG-46PR (PAIR)
<b>Replacement Red Net</b>	FHG-46N (EACH)
<b>Replacement Blue Net</b>	STG-46N (EACH)



### ARCHERY TARGET STAND

Adjustable target stand for 24" to 48" targets.

- Target not included
- 3 Year Limited Warranty

PE-120 (EACH)



### ARCHERY TARGET TRIPOD

Adjustable target tripod for 24" to 48" targets. Collapses for compact storage!

- Target not included
- 3 Year Limited Warranty

PE-121 (EACH)



### JUMP ROPE RACK

- 27" wall-mounted storage rack
- (5) 10" long pegs for storage
- 3 Year Limited Warranty

PE-110 (EACH)





### COURT/SIDE LINE HYDRATION CART

Roll from court to locker room with a fully loaded cart. Holds two medium trash bins underneath and 2, 3, 5, or 10 gallon coolers (not included). Heavy-duty frame with full side panels that can be used for logo's or school spirit.

- Heavy duty powder coated, welded steel construction
- Adjustable arms can adjust to your cooler size for added safety and will hold the cooler in place
- Can accommodate a cooler size up to 10 gallons (not included)
- (4) Non-marking casters with (2) wheels that can be locked
- For indoor and outdoor use
- Side panels are available for customization. Add your team or organization's logo
- Dimensions: 46" H x 26" L x 20" W
- 1 Year Limited Warranty

HCC-520 (EACH)



Keep your team hydrated!  
This cart is easy to move  
but steady when in place.



### PORTABLE BICYCLE RACK



Durable all-welded rack for bicycles and mopeds. Available in 4 sizes! *Call for freight quote.*

- Galvanized steel frame with gray powder coat finish
- 3 Year Limited Warranty

Item #	Capacity	Size	UoM
OBR-16	16	102"L x 30"W x 30"H	(EACH)
OBR-10	10	67"L x 30"W x 30"H	(EACH)
OBR-8	8	55"L x 30"W x 30"H	(EACH)
OBR-6	6	47"L x 30"W x 30"H	(EACH)



TE-2



## MINI TOTEMASTER™

Indoor/outdoor all-purpose carrier. No tools required for assembly.

- Holds 10-12 balls
- Lockable hinged top (lock not included)
- 21"L x 21"W x 30"H
- 3 Year Limited Warranty

TE-30 (EACH)



## THE ORIGINAL TOTEMASTER™

Indoor/outdoor all-purpose carrier. No tools required for assembly.

- Holds 20-25 balls
- Lockable hinged top (lock not included)
- 36"L x 24"W x 36"H
- 3 Year Limited Warranty

**Royal Blue** TE-2 (EACH)



## TOTEMASTER™ PLUS

All-purpose carrier with large storage capacity.

- Holds 30-35 balls
- Divider included to separate equipment
- Lockable hinged dual tops (lock not included)
- 60"L x 24"W x 36"H
- 3 Year Limited Warranty

TE-60 (EACH)

## REPLACEMENT CASTER AND INSERT KIT

- 4 non-marking 3" swivel casters and inserts
- 3 Year Limited Warranty



*Specify push-in or screw-in model needed when ordering.*

TE-2HK (KIT)





**TOTEMASTER™ ALL-TERRAIN**

Durable indoor/outdoor all-purpose carrier.

- 12" all-terrain wheels on rear
- Lockable hinged top (lock not included)
- 36"L x 24"W x 36"H
- 3 Year Limited Warranty

AT-5 (EACH)



**TOTEMASTER™ FIELD**

Durable indoor/outdoor all-purpose carrier.

- 20" all-terrain wheels on rear
- Lockable hinged top (lock not included)
- 51"L x 25"W x 48"H
- 3 Year Limited Warranty

AT-10 (EACH)



**TOTEMASTER™ OPEN TOP**

All-purpose carrier with open top storage baskets.

- Rotating hangers included for jump rope and hoop storage
- Optional side shelf (TE-PESHELF) sold separately
- 48"L x 26"W x 54"H
- 3 Year Limited Warranty

TE-PE01 (EACH)

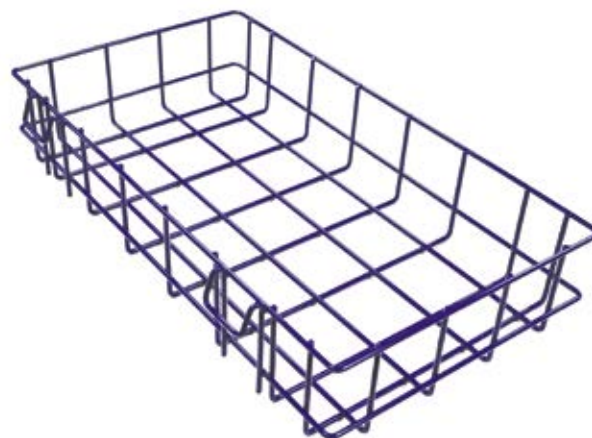

**TOTEMASTER™ STORAGE SHELF**

Add to the side of your Open Top carrier or ToteMaster™ storage carriers.

- Use to hold sanitation or other supplies
- 22"L x 13"W x 4"D

TE-PESHELF (EACH)

# ATLAS SERIES™ BALL CARTS & LOCKERS

Heavy-duty ball carts and lockers that survive the test of time. Strong enough to store medicine balls!

- 1" thick-walled steel frames with black powder coat finish
- Non-marking swivel casters (Ball Locker & Hamper (BBABL-2) has all-terrain wheels on rear)
- Ball lockers include lockable hinged top (lock not included)
- 3 Year Limited Warranty



## ATLAS SERIES™ BALL LOCKER & HAMPER

- Holds 25+ balls
- Mesh hamper liner included for towels/uniforms storage
- 45"L x 24"W x 35"H



BBABL-2 (EACH)



## ATLAS SERIES™ BALL LOCKER

- Holds 25+ balls
- 47"L x 24"W x 37"H

BBABL-1 (EACH)



## ATLAS SERIES™ BALL CART

- Holds 15 balls
- 51½"L x 18"W x 36"H

BBABC-1 (EACH)



## ATLAS SERIES™ DOUBLE BALL CART

- Holds 30 balls
- 51½"L x 24"W x 36"H

BBABC-2 (EACH)





## STACKMASTER™ WALL RACKS

Heavy-duty steel ball racks permanently mount to gymnasium wall.

- Lockable top/bottom bars (lock not included)
- Mounting hardware not included
- Single Wall Rack - 15"W x 66"H x 12"D
- Double Wall Rack - 37"W x 66"H x 12"D
- 3 Year Limited Warranty

**Single** PE-140 (EACH)

**Double** PE-240 (EACH)



## DELUXE TRAINING BALL RACK

Durable steel rack for shooting competitions and free throw practice.

- Holds 19 regulation basketballs (top 7 feed to shooter)
- Non-marking swivel wheels (front 2 lockable)
- 61"L x 18"W x 44"H
- 3 Year Limited Warranty

DTBR-19 (EACH)

## PREMIUM BALL CARRIER

Durable steel frame carrier with side panels for optional custom graphics on both ends.

- Non-marking swivel wheels
- 39"L x 22"W x 36"H
- 3 Year Limited Warranty

DTBR-12 (EACH)

### Optional Custom Graphics

DTBR-GRAPH (PAIR)



Optional Custom Graphics



BBC-12RD



Holds Basketballs  
Medicine Balls  
Volleyballs

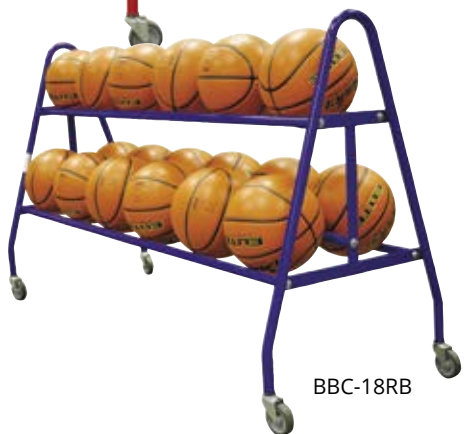

BBC-18RB



## DELUXE BALL CARRIERS

Durable steel frame carriers hold basketballs, volleyballs, and medicine balls.

- Non-marking swivel wheels
- 12 Ball Carrier - 39"L x 22"W x 36"H
- 18 Ball Carrier - 60"L x 22"W x 36"H
- 3 Year Limited Warranty

**12 Ball - Royal Blue** BBC-12RB (EACH)

**12 Ball - Black** BBC-12BK (EACH)

**12 Ball - Red** BBC-12RD (EACH)

**18 Ball - Royal Blue** BBC-18RB (EACH)

**18 Ball - Black** BBC-18BK (EACH)

**18 Ball - Red** BBC-18RD (EACH)

Surround your field with **FIELDPRO™** netting for a safer design and professional look!



Customize your Field and Facility with Barrier net options with several poles and nets to choose from.

- Straight poles with aluminum or powder coat finish
- 1¾", 3½" or 4" square mesh net
- Easy to use hoist system for quick install/removal of net
- Ground sleeves for system removal

Work with our Engineers to make our netting options work for you.



We can customize any field layout per your request!

**10' Straight Pole** with multi-sport net is ideal for use as a Lacrosse and Field Hockey backstop net. The net is clipped at the top and bottom of each pole.

**15', 20', 25', 30', and 40' Straight Pole** comes with a hoist system allowing quick and easy lowering/removal of the net after the game, season, or before a big storm. Reinstalling the net is a snap - all from ground level with no need for a ladder.

### Features:

- Pulley system to raise/lower net (excludes 10' poles)
- (4) net options to choose from
- Ground sleeves facilitate installation and allow for system removal as needed
- Covers for ground sleeves are sold separately
- 3 Year Limited Warranty: System

*Call for freight quote and pricing.*



**Visit [JAYPRO.COM](http://JAYPRO.COM) for product specifications and  
Call your Jaypro Sports Rep to help design your field TODAY!**

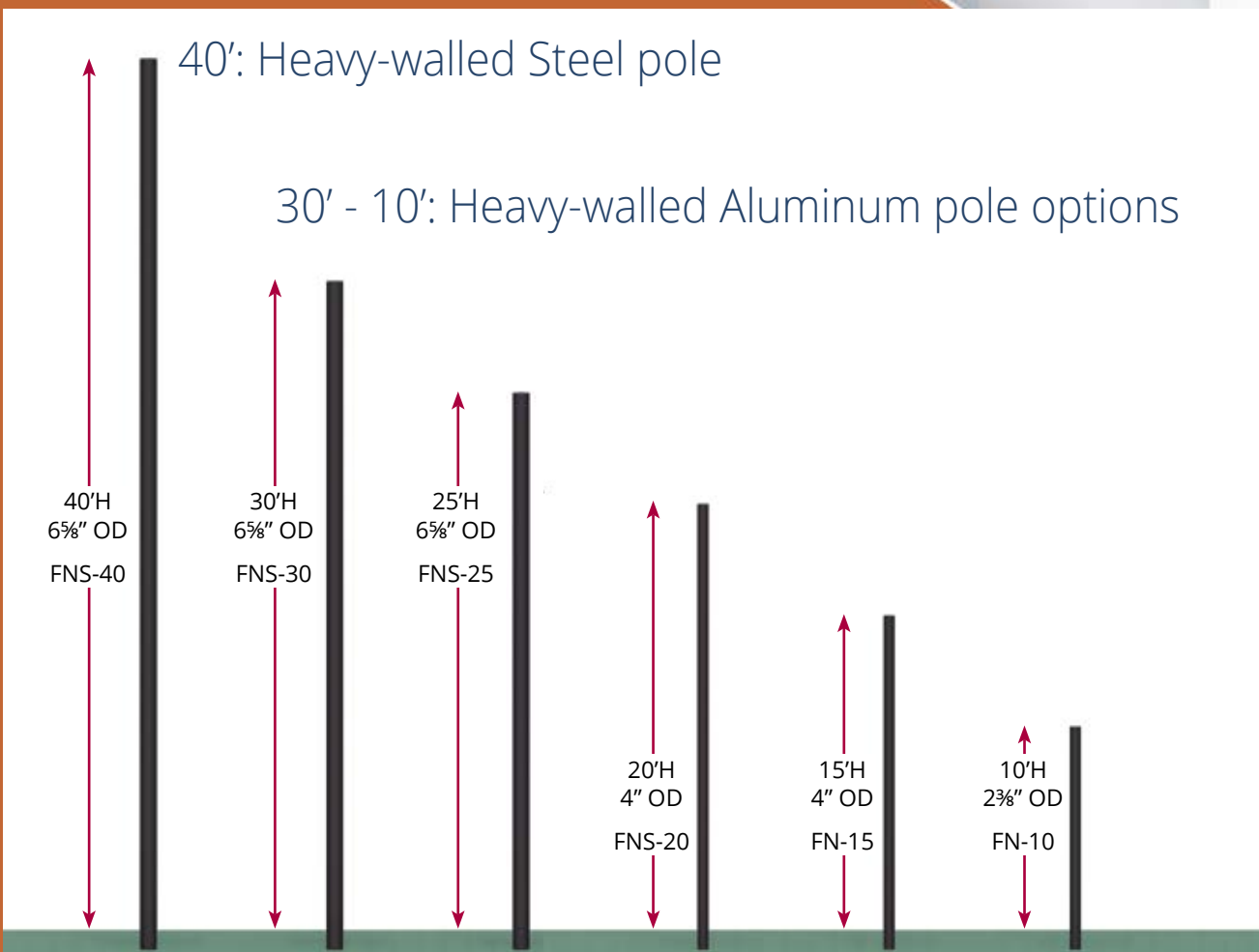

## FIELDPRO™ MULTI-SPORT NET SYSTEM



Ball stop net system for lacrosse, field hockey, and other field sports. Ensure the safety of athletes, coaches, and spectators!

- (4) 4" heavy-walled aluminum uprights and ground sleeves
- Ground sleeve covers optional (FN-20-C)
- #36 knotted black nylon net with 1¾" sq. mesh
- Pulley system and corrosion-resistant hardware included
- 3 Year Limited Warranty: System

*Standard upright color is black. Custom colors available upon request for additional charge. Freight quote required.*

**15'H x 65'W** FNMB-65 (EACH)



## FIELDPRO™ FOOTBALL NET SYSTEM



Keep field goals and extra point kicks away from spectators and inside the field. Easy-to-use pulley system raises/lowers net!

- (2) 6½" heavy-walled aluminum or 8½" heavy-walled steel uprights, (each upright is a 2-piece design) with ground sleeves
- Ground sleeve covers optional (FN-30-D)
- #36 knotted black nylon net with 3½" sq. mesh
- Pulley system and corrosion-resistant hardware included
- 3 Year Limited Warranty: System

*Standard upright color is black. Custom colors available upon request for additional charge. Freight quote required.*

<b>30'H x 40'W - 6½" aluminum</b>	FNFB-30 (EACH)
<b>30'H x 50'W - 6½" aluminum</b>	FNFB-3050 (EACH)
<b>40'H x 40'W - 6½" aluminum</b>	FNFB-40 (EACH)
<b>40'H x 60'W - 8½" steel</b>	FNFB-4060 (EACH)
<b>50'H x 50'W - 8½" steel</b>	FNFB-5050 (EACH)
<b>50'H x 60'W - 8½" steel</b>	FNFB-5060 (EACH)

## FIELDPRO™ SOCCER NET SYSTEM



Ensure the safety of athletes, coaches, and spectators.

- (4) 4" heavy-walled aluminum uprights and ground sleeves
- Ground sleeve covers optional (FN-20-C)
- #36 knotted black nylon net with 3½" sq. mesh
- Pulley system and corrosion-resistant hardware included
- 3 Year Limited Warranty: System

*Standard upright color is black. Custom colors available upon request for additional charge. Freight quote required.*

**20'H x 65'W** FNSB-65 (EACH)





# FIELDPRO™ NET SYSTEM



## PORTABLE FIELDPRO™ NET SYSTEM

Lightweight indoor/outdoor portable net system for fields and courts where in-ground sleeve systems are not an option. Can also be used as a multi-field/court space divider!

- Easy net assembly with cable clamps and sliding rings
- 12' tall x 2 3/8" dia. aluminum poles on tip-and-roll bases with no-flat tires
- Counterweight containers and corrosion-resistant hardware included
- Optional vinyl base covers (PFN-BCVR) sold separately
- 3 Year Limited Warranty: System

*Poles can be powder coated black (specify when ordering). Typical pole spacing is 18' apart and should not exceed 20'. Sold per base dependent on overall length needs (specify when ordering).*

*NOTE: It is the customer's responsibility to fill counterweight containers.*



## PORTABLE FIELDPRO™ NET SYSTEM PACKAGE



Keep balls on the field and ensure the safety of spectators.

Package Includes:

- 4 poles with black powder coat or mill finish
- 4 bases with (16) 5 gallon jugs
- 1 3/4" knotted nylon net
- Red vinyl base covers included
- 12'H x 60'L
- 3 Year Limited Warranty: System

**Package** PFN-1260PKG (PKG)



## FIELDPRO™ NET SYSTEM BASE COVER



Vinyl base cover slides over counterweight containers. Standard color is red. 1 Year Limited Warranty.

**Red** PFN-BCVR (EACH)



## POLE VAULT LANDING SYSTEMS

Uniquely fabricated landing systems with varying densities. Reinforced vinyl coating (22 oz. for high school and 18 oz. for collegiate styles) with spike resistant top pad. 13 Year Limited Warranty on system, and 1 Year Limited Warranty on cover. *Specify vinyl color when ordering. Call for freight quote.*

### HIGH SCHOOL SYSTEM

TFP-LSHS



**VINYL COLORS:**



Color options available



### COLLEGIATE SYSTEM

TFP-LSC



### HIGH SCHOOL



20' x 21' x 26"

Cover

Package

Package includes: landing system, top pad, weather cover, standard pads, pole vault standards and crossbar.

TFP-LSHS (SYS)  
TFP-LSCHS (EACH)  
TFPVPKG1 (PKG)



### COLLEGIATE



22' x 24' x 32"

Cover

TFP-LSC (SYS)  
TFP-LSCC (EACH)

### HIGH SCHOOL POLE VAULT STANDARD



Pole standard adjusts from 6' to 18'. Durable rust-resistant steel risers have easy grip handles for height adjustment and "spin t-handles" to lock riser in place. Base with 32" adjustability. 1 Year Limited Warranty. *Call for freight quote.*

TFP-STHS (PAIR)

High School TFP-STHS



### COLLEGIATE POLE VAULT STANDARD



Aluminum uprights with telescoping riser adjusts from 9' to 21'. Uprights are mounted on offset steel carriage that rides on pulley wheels (adjusts from 0-32"). 1 Year Limited Warranty. *Call for freight quote.*

TFP-STC (PAIR)

14' 10" Crossbar  
TFP-XB (EACH)

TFP-XB



Collegiate TFP-STC

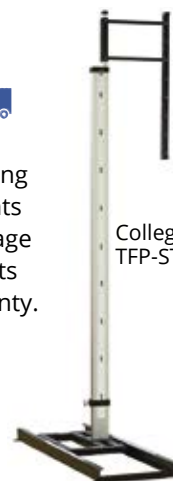



# HIGH JUMP

## HIGH JUMP LANDING SYSTEMS

Three base sections buckle at ends with seams covered by 3" hook-and-loop strips. 2" top pads cover sections. 13 Year Limited Warranty on system, and 1 Year Limited Warranty on cover. *Specify vinyl color when ordering. Call for freight quote.*

### HIGH SCHOOL SYSTEM

TFHJ-SYHS



Color options available



#### VINYL COLORS:



### COLLEGIATE SYSTEM

TFHJ-SYC



### HIGH SCHOOL



#### Straight Front Design

16'6"W x 8'D x 26"H TFHJ-SYHS (SYS)

Cover TFHJ-SYCHS (EACH)

Package TFHJPKG1 (PKG)

Package includes: landing system, top pad, weather cover, standard pads, high jump standards and crossbar.



#### Front Cut-Out Design

16'6"W x 8'D x 26"H TFHJ-SYHSCO (SYS)

Cover TFHJ-SYHSCV (EACH)

Package TFHJPKG2 (PKG)

Package includes: landing system, top pad, weather cover, standard pads, high jump standards and crossbar.



### COLLEGIATE



18'W x 10'D x 28"H TFHJ-SYC (SYS)

Cover TFHJ-SYCC (EACH)

Package TFHJPKG3 (PKG)

Package includes: landing system, top pad, weather cover, standard pads, high jump standards and crossbar.



### HIGH SCHOOL HIGH JUMP STANDARD



Zinc plated water-resistant standards adjust from 2' to 8' in ¼" intervals. 16" base with roll away feature. Metric scale in cm. 62 to 244. 1 Year Limited Warranty. *Call for freight quote.*

TFHJ-STHS (PAIR)

13' 1½" Crossbar  
TFHJ-XB (EACH)

High School  
TFHJ-STHS



TFHJ-XB



### COLLEGIATE HIGH JUMP STANDARD



Aluminum uprights with telescoping riser adjusts from 1½' to 9'. Steel roll away base with adjusting leveling screws. Measurements in standard and metric. 1 Year Limited Warranty. *Call for freight quote.*

TFHJ-STC (PAIR)

Collegiate  
TFHJ-STC





## HIGH SCHOOL STARTING BLOCK

Lightweight aluminum construction starting system has 5" wide 4 position adjustable pedals and a 3" center rail. All-weather spikes included. 3 Year Limited Warranty. *Call for freight quote.*

TFSB-HS (EACH)



## COLLEGIATE STARTING BLOCK

Highest quality lightweight all aluminum casting starting system with 5 pedal angle adjustments. Pedals will not come off rail during transport. Includes a center rail for carrying, threaded spikes for synthetic surface and threaded spike inserts. 3 Year Limited Warranty. *Call for freight quote.*

TFSB-C (EACH)

## ELITE HIGH SCHOOL HURDLES



TFH-HS



TFRH-HS

Stackable, aluminum design with spring loaded buttons for easy height adjustment of 30", 33", 36", 39" & 42". Welded base construction for superior strength. 3 Year Limited Warranty. *Call for freight quote.*

**Elite Hurdle**

TFH-HS (EACH)

**Rocker Hurdle**

TFRH-HS (EACH)



## COLLEGIATE HURDLE

Extruded aluminum base with beveled edges make for a sleek and stable easy stack design. Spring-loaded riser adjusts from 30", 33" 36", 39" & 42" and spring-loaded weights easily adjust to correct pullover weight for all heights. 3 Year Limited Warranty. *Call for freight quote.*

TFH-C (EACH)



## HURDLE CART



Heavy-duty 6-wheel steel cart carries 8-14 hurdles. Unique design helps transport hurdles over curbs and through rough grass or loose gravel. Cart accommodates both high school and collegiate hurdles. 3 Year Limited Warranty. *Call for freight quote.*

TFH-CART (EACH)





**6 Pole Layout**

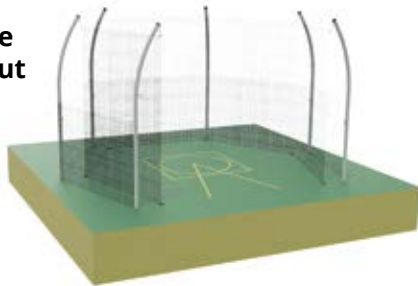

**4 Pole Layout**

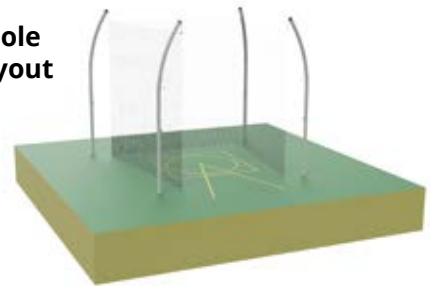

**DISCUS CAGE**



Durable semi-permanent discus cage with pulley system to setup/remove net. Ideal for high schools.

- (6) 4" heavy-walled aluminum poles (14'6" tall with 24" offset)
- Individual swivel pulley hoist system per pole
- Black powder coat or mill finish
- Heavy-duty weather treated 1 7/8" #42 nylon mesh black net
- Ground sleeves (DCHS-6S) and barrier net (DCHS-BN) sold separately
- 3 Year Limited Warranty: Cage & Sleeves

*Call for freight quote.*

- Discus Cage w/Net - No Sleeves**
- Repl. Cage Net - 55'L x 14'H**
- Repl. Ground Sleeves - Set of 6 (DCHS-35) + Barrier Net - No Sleeves**
- Repl. Barrier Net - 63'L x 7'H**

- DCHS-35 (EACH)
- DCHS-35NET (EACH)
- DCHS-6S (SET)
- DCHS-35BN (EACH)
- DCHS-BN (EACH)

**SHOT CAGE**



- Accommodates throwing sector at 34.92 degrees
- (4) 4" O.D. curved aluminum poles with 2' offset
- Individual swivel pulley hoist system per pole
- Black powder coat or mill finish
- Heavy-duty weather treated 1 7/8" #42 nylon mesh black net
- Ground sleeves (SC-25S) sold separately
- 3 Year Limited Warranty: Cage & Sleeves

*Call for freight quote.*

- Cage** SC-25 (EACH)
- Ground Sleeves - Set of 4 (SC-25) + Barrier Net - No Sleeves** SC-25S (SET)
- SC-25BN (SET)



**CEILING SUSPENDED RETRACTABLE THROWING CAGE**

Nets can be mounted to a retractable frame or extend the full ceiling height. Net configuration may be straight or U-shaped to meet USTF, NCAA, and NFHS requirements.

Cage easily raises and lowers from ceiling via electric winch(s).

*Call for details, pricing and freight quote.*



### STAINLESS STEEL POLE VAULT BOXES

Pole vault boxes available in heavy gauge steel with white paint finish or smooth finished 12 gauge stainless steel. Optional steel lid available. 3 Year Limited Warranty. *Call for freight quote.*

<b>Stainless Box</b>	TFP-SS (EACH)
<b>Stainless Lid</b>	TFP-SL (EACH)

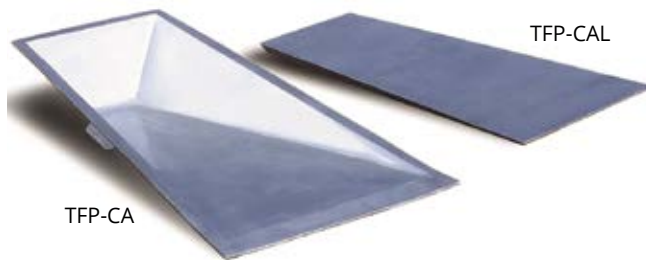

### CAST ALUMINUM POLE VAULT BOX



Thick walled aluminum casting with rounded inside corners for easy rotation of pole in box. Optional lid has textured finish and may be covered with synthetic surface to match runway. 3 Year Limited Warranty. *Call for freight quote.*

<b>Aluminum Box</b>	TFP-CA (EACH)
<b>Aluminum Lid</b>	TFP-CAL (EACH)



### OFFICIAL CIRCLES

Shot and discus circles made of 1" x 3/4" x 1/4" aluminum. Four sections with anchoring holes. *Call for freight quote.*

<b>Shot</b>	TFSR (EACH)
<b>Discus</b>	TFDR (EACH)



### WEBBED CIRCLES / RINGS

Discus and shot/hammer rings with welded cross braces for added rigidity. Bolted together before installation to ensure circle stays round. *Call for freight quote.*

<b>Shot/Hammer</b>	TFTC-SHC (EACH)
<b>Discus</b>	TFTC-DC (EACH)



### CAST ALUMINUM TOEBOARD PADS

Depressed pads and level pads are cast aluminum construction and meet all rule specifications. *Call for freight quote.*

<b>Depressed Pad</b>	TFTB-ADP (EACH)
<b>Level Pad</b>	TFTB-ALP (EACH)



### POLY TOEBOARD DEPRESSED PAD

Designed with Linear Low-Density Polyethylene (LLDPE) and UV stabilizer for maximum durability. *Call for freight quote.*

TFTB-PLY (EACH)
-----------------





### 8" LONG JUMP TAKE-OFF BOARD

Official 48" x 8" take-off board. 3/4" polyurethane top surface on 1 1/2" x 8" plastic under board. *Call for freight quote.*

TFLJ-B (EACH)



### 20" LONG/TRIPLE JUMP TAKE-OFF BOARD

Two part poly board 48" x 20" with soft texture 3/4" top board attached to a high density 3/4" poly under board. *Call for freight quote.*

TFLJ-P20 (EACH)



### 8" LONG/TRIPLE JUMP TAKE-OFF BOARD TRAY

8" zinc plated steel tray system. Board mounted to steel framework with 6 adjusting bolts. *Call for freight quote.*

TFLJ-P8 (SYS)

### 12" LONG/TRIPLE JUMP TAKE-OFF BOARD SYSTEM

12" tray system with take-off board, 1/2" plywood foul board, and heavy-duty steel lid. Foul board can be replaced with plasticine for meets. *Call for freight quote.*



TFLJ-W12L (EACH)



### 20" LONG/TRIPLE JUMP TAKE-OFF BOARD TRAY

20" stainless steel tray system with drain holes for permanent installation in synthetic runways. *Call for freight quote.*

TFLJ-TR (EACH)

## SAND PIT FORMS



Structure is made of specially folded 1/8" aluminum with built in ledge to receive sand pit cover. The sand catcher system allows sand to be conveniently stored when the pit is covered. Minimum distance from takeoff board to back of pit is 10 meters. Available in 3 sizes. *Call for freight quote.*

### Sand Pit Form

- 23'** TFSP-23 (CALL)
- 26'** TFSP-26 (CALL)
- 29'** TFSP-29 (CALL)



# TENNIS & PICKLEBALL POSTS



RTP-300 RTP-300BK STP-200 STP-200BK



RTP-278

RTP-278BK



PPR10GR

PPR10BK

## Tennis: Outdoor

Item #	Post Size	Winch	Color	Net Rail
RTP-300	3" ROUND	Internal	Green	Yes
RTP-300BK	3" ROUND	Internal	Black	Yes
STP-200	3" SQUARE	Internal	Green	Yes
STP-200BK	3" SQUARE	Internal	Black	Yes
TP278BK	2-7/8" ROUND	Internal	Black	Yes
TP278GR	2-7/8" ROUND	Internal	Green	Yes
RTP-278	2-7/8" ROUND	External	Green	No
RTP-278BK	2-7/8" ROUND	External	Black	No
TP-125	3-1/2" ROUND	External	Green	No

## Tennis: Indoor

Item #	Post Size	Winch	Color	Net Rail
ITS-300	3" ROUND	Internal	Green	Yes

For more information, scan below or go to:  
[www.Jaypro.com/Tennis](http://www.Jaypro.com/Tennis)



## Pickleball: Outdoor

Item #	Post Size	Winch	Color	Net Rail
PKB300-GR	3" ROUND	Internal	Green	Yes
PKB300-BK	3" ROUND	Internal	Black	Yes
PKB278-GR	2-7/8" ROUND	Internal	Green	Yes
PKB278-BK	2-7/8" ROUND	Internal	Black	Yes
PPR10GR	2-7/8" ROUND	External	Green	No
PPR10BK	2-7/8" ROUND	External	Black	No

## Pickleball: Indoor

Item #	Post Size	Winch	Color	Net Rail
PPR15GR	2-7/8" ROUND	External	Green	No
PPR15BK	2-7/8" ROUND	External	Black	No

For more information, scan below or go to:  
[www.Jaypro.com/Pickleball](http://www.Jaypro.com/Pickleball)





## ROUND

## SQUARE



RTP-300

RTP-300BK

STP-200

STP-200BK

### 3" CLUB TENNIS POSTS

- Available in 3" round or square posts
- 11 gauge steel construction
- Solid stainless steel internal worm gear winch with self-locking mechanism to prevent recoiling during winding
- Welded lacing rods for net attachment included
- Removable winch handle
- Nets (TTN-3, TPL-5, CCPTN42) sold separately
- Ground sleeves (RTPGS-3, STPGS-2) for semi-permanent installation sold separately
- 3 Year Limited Warranty

<b>Round - Green</b>	RTP-300 (PAIR)
<b>Round - Black</b>	RTP-300BK (PAIR)
<b>Square - Green</b>	STP-200 (PAIR)
<b>Square - Black</b>	STP-200BK (PAIR)



RTPGS-3

### 3" GROUND SLEEVES

<b>(RTP-300) - 24"L</b>	RTPGS-3 (PAIR)
<b>(STP-200) - 24"L</b>	STPGS-2 (PAIR)

### REPLACEMENT WINCH

**Round Winch & Handle**  
RTP-300WH (EACH)

**Square Winch & Handle**  
STP-200WH (EACH)



RTP-278BK

RTP-278

### 2 7/8" TENNIS POSTS

- 2 7/8" heavy-walled steel pipe
- Heavy-duty self-locking winch with removable handle
- Low profile die cast top cap
- Adjustable height stop collar
- Semi-permanent installation capable
- 2 powder coat colors with zinc undercoat available
- Ground sleeves and net sold separately
- 3 Year Limited Warranty

<b>Black Post</b>	RTP-278BK (PAIR)
<b>Green Post</b>	RTP-278 (PAIR)
<b>Ground Sleeves</b>	TP-278G (PAIR)
<b>Repl. Green Ratchet Reel</b>	RT-10GR (EACH)
<b>Repl. Black Ratchet Reel</b>	RT-10BLK (EACH)
<b>Repl. Green Top Cap</b>	CAP-10GR (EACH)
<b>Repl. Black Top Cap</b>	CAP-10BLK (EACH)



RT-10BLK

### RATCHET REEL



RT-10GR

### TOP CAP



CAP-10BLK



CAP-10GR



TP278GR

TP278BK

### 27/8" TENNIS POSTS

- 27/8" heavy-walled steel pipe
- 11 gauge steel construction
- Solid stainless steel internal worm gear winch with self-locking mechanism to prevent recoiling during winding
- Welded lacing rods for net attachment included
- Removable winch handle
- Nets (TTN-3, TPL-5, CCPTN42) sold separately
- Ground sleeves (TP-278G) for semi-permanent installation sold separately
- 3 Year Limited Warranty

**Green** TP278GR (PAIR)

**Black** TP278BK (PAIR)

**Ground Sleeves** TP-278G (PAIR)



### 3 1/2" HEAVY-DUTY TENNIS POSTS

- 3 1/2" heavy-walled round steel green posts
- Steel top pulley caps with 1 3/4" dia. aluminum pulley
- Tensioning ratchet with spring-loaded safety latch
- Removable handle
- Assembly hardware included
- Nets (TTN-3, TPL-5, CCPTN42) sold separately
- Ground sleeves (TP-150G) for semi-permanent installation sold separately
- 3 Year Limited Warranty

**Green** TP-125 (PAIR)

**3 1/2" Ground Sleeves** TP-150G (PAIR)



### RATCHET REEL

- Heavy-duty ratchet reel fits existing posts
- Removable handle
- Safety latch to prevent fly-away
- 3 Year Limited Warranty

**Green** RT-5GR (EACH)

**Black** RT-5BK (EACH)

### TOP CAP

- Fits 3 1/2" OD post
- 1 3/4" pulley sheave & set screws included
- 3 Year Limited Warranty

**Green** CAP-35 (EACH)

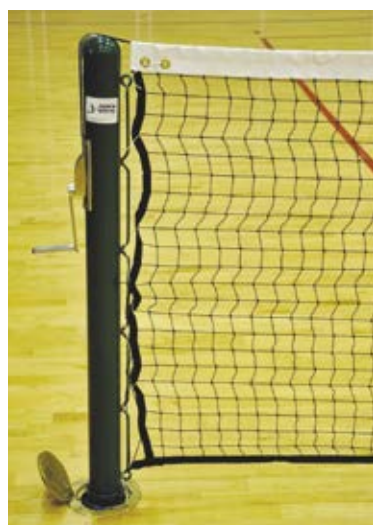

### 3" DELUXE INDOOR TENNIS POSTS

- 3" round posts
- Designed for use with standard 3" x 10" indoor floor sleeves and cover (see page 20)
- Solid stainless steel internal worm gear winch with self-locking mechanism to prevent recoiling during winding
- Removable winch handle
- Net sold separately
- 3 Year Limited Warranty

ITS-300 (PAIR)



# PORTABLE PICKLEBALL



## **RALLY** PICKLEBALL **RPP-3PORT**

**Portable Pickleball system for Indoor/Outdoor play, when in-ground installation is not available or desired. Heavy duty non-scuff wheels allow for ease of movement and the wheels can be stored easily when in play.**

USAP compliant. 22' L x 36" H (when fully extended). Durable black powder coated finish resists rust and increases durability. The frame is constructed of heavy-duty 7 and 11-gauge steel. Provides proper tension on the net, no sagging, when fully extended.

### **Features:**

- Portable net system
- Collapsible frame reduces storage requirements. The frame can be collapsed to 13½' or 7' long
- 3-inch removable, round powder coated uprights with an internal self-locking winch
- Wheel assembly can be flipped up or removed during play with a quick release pin lock
- 2-foot cross members ("feet") stabilize the net system when it is on the ground, these can be removed for storage
- 21'L x 32"H net (PT-21N) included

**System** RPP-3PORT (EACH)

# OUTDOOR PICKLEBALL POSTS



## DELUXE PICKLEBALL POSTS

- Official 36" height
- 2 7/8" heavy-walled steel pipe
- Heavy-duty self-locking winch with removable handle
- Low profile die cast top cap
- Adjustable height stop collar
- Semi-permanent installation capable
- 2 powder coat colors with zinc undercoat available
- Ground sleeves and net sold separately
- 3 Year Limited Warranty

<b>Black Post</b>	PPR10BK (PAIR)
<b>Green Post</b>	PPR10GR (PAIR)
<b>Ground Sleeves</b>	TP-278G (PAIR)
<b>Repl. Green Ratchet Reel</b>	RT-10GR (EACH)
<b>Repl. Black Ratchet Reel</b>	RT-10BLK (EACH)
<b>Repl. Green Top Cap</b>	CAP-10GR (EACH)
<b>Repl. Black Top Cap</b>	CAP-10BLK (EACH)



**TOP CAP**

CAP-10BLK



CAP-10BLK



RT-10GR

**RATCHET REEL**



RT-10BLK

## PICKLEBALL PACKAGE

Package Includes:

- (1 pair) Deluxe Pickleball posts in Black or Green (PPR10)
- (1) Pickleball Net (PT-21N)



<b>Black Post</b>	PPR10BKPKG (PKG)
<b>Green Post</b>	PPR10GRPKG (PKG)



## 2 7/8" OR 3" OUTDOOR PICKLEBALL POSTS

- Official 36" height - 2 7/8" or 3" round heavy-walled steel pipe
- Available in green or black
- 11 gauge steel construction
- Solid stainless steel internal worm gear winch with self-locking mechanism to prevent recoiling during winding
- Welded lacing rods for net attachment included
- Removable winch handle
- Net (PT-21N) and ground sleeves (2 7/8" - TP-278G or 3" - RTPGS-3) sold separately

### 2 7/8" Round Post

<b>Green</b>	PKB278-GR (PAIR)	<b>Black</b>	PKB278-BK (PAIR)
--------------	------------------	--------------	------------------

### 3" Round Post

<b>Green</b>	PKB300-GR (PAIR)	<b>Black</b>	PKB300-BK (PAIR)
--------------	------------------	--------------	------------------





## INDOOR PICKLEBALL POSTS

- Official 36" height
- 10" in-floor depth
- 2 7/8" heavy-walled steel pipe
- Heavy-duty self-locking winch with removable handle
- Low profile die cast top cap
- 2 powder coat colors with zinc undercoat available
- Floor sleeves with covers (PPR-15G) and net (PT-21N) sold separately
- 3 Year Limited Warranty

<b>Black Post</b>	PPR15BK (PAIR)
<b>Green Post</b>	PPR15GR (PAIR)
<b>Floor Sleeves &amp; Covers</b>	PPR-15G (PAIR)

## PORTABLE PICKLEBALL NET SET

Game quicker and easier on nearly any surface with this set. Meets USAPA requirements!

- Carry bag included
- 22'L x 34"H
- 1 Year Limited Warranty

**System** PKBL10 (EACH)



### CENTER STRAP

- 2" adjustable nylon webbing
- Double snap hook

**Strap** CS-1 (EACH)

### CENTER ANCHOR

- Zinc coated steel anchor with stainless steel drive pin for easy snap assembly

**Anchor** A-2 (EACH)



## COURT SPONGE ROLLER

- 36" wide seamless tennis court roller
- Remove water from the court
- 1 sponge included

**Roller**  
TCSR (EACH)

**Replacement Sponge**  
TCSR-RR (EACH)





## COUNTRY CLUB TENNIS NET

- 3.5mm braided black polyethylene net, 1¾" knotted mesh
- Top 7 rows double meshed
- 51 oz. double layered reinforced white vinyl headband
- 18 oz. x 2½" side pockets (black) with ½" fiberglass rod with 5 build-in grommets
- Tapered net bottom that includes center strap
- 41'-7"L x 42"H

CCPTN42 (EACH)

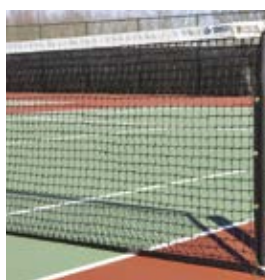

## TOURNAMENT TENNIS NET

- 3mm braided black polyethylene net
- Top 7 rows double meshed
- 51 oz. double layered multi-stitched heavy-duty vinyl headband
- 18 oz. side pockets with ½" fiberglass dowel
- Tapered net bottom and includes center strap
- 41'-7"L x 42"H

TTN-3 (EACH)



## COLLEGIATE TENNIS NET

- 3mm twisted black polyethylene net
- 51 oz. multi-stitched heavy-duty vinyl headband
- Synthetic taped sides, tapered net bottom and includes center strap
- 6mm vinyl coated steel cable
- 42'L x 42"H

TPL-5 (EACH)



## ECONOMY TENNIS NET

- Lightweight and weather-resistant
- 2mm knotless nylon net with 1½" sq. mesh
- 2" vinyl headband with ¼" dia. nylon cord cable
- Taped side and bottom edges
- 42'L x 42"H

TDP-42 (EACH)



## COMPETITION PICKLEBALL NET

- 2.5mm twisted polyethylene, 1¾" square black mesh
- Double mesh over top 5 rows
- Top headband is 2½" white woven polyester, 2½" PVC side fabric and ½" fiberglass dowel rods
- Top cord: 4mm vinyl coated steel cable
- Indoor/outdoor use
- 21'L x 32"H

PT-21N (EACH)

## COURTSIDE BENCHES

Portable 5' aluminum benches for courtside viewing. See (page 192) for information on these benches.



PB40



PB40PC



DPB50



DPB50PC





### COMPETITION BADMINTON PACKAGE



Durable uprights designed for high school, intramural and recreational competition level play. Official height!

- 2 $\frac{3}{8}$ " x 61" aluminum uprights, powder coated white, with fixed net height
- Package includes (2) uprights and net
- Floor sleeves/covers sold separately

<b>Package</b>	BSO-PKG (PKG)
<b>Uprights Only</b>	BSO-2U (PAIR)
<b>Net</b>	BND-1 (EACH)
<b>Floor Sleeve &amp; Brass Cover</b>	BSO-2G (PAIR)



### CLASSIC WIND SCREEN

8 oz./sq. yd. vinyl coated polyester mesh provides 84% shade.

<b>Classic Screen - 6'H</b>	TWS-6 (SQ FT)
<b>Classic Screen - 9'H</b>	TWS-9 (SQ FT)



### PREMIUM WIND SCREEN

14 oz./sq. yd. vinyl coated polyester mesh provides 75% shade.

<b>Premium Mesh Screen - 6'H</b>	WSCRN-6 (SQ FT)
<b>Premium Mesh Screen - 9'H</b>	WSCRN-9 (SQ FT)

See (page 103) for details about these products.

**WIND SCREEN COLORS:**



# PLAYER BENCHES

## PLAYER BENCH



Sturdy rust-resistant aluminum bench for athletic fields, public parks, and sport complexes.

- 10" wide non-skid seat planks
- Heavy-duty rust-resistant steel legs
- Portable, in-ground, or surface mount installation
- Floor protection kit (PSS-4FT) for indoor use sold separately
- 3 Year Limited Warranty

Specify plank colors when ordering powder coat option.  
Additional powder coat options available. (CALL)

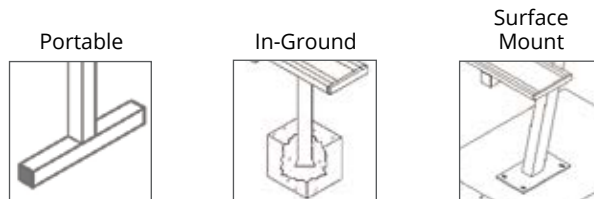

### PLANK POWDER COAT COLORS:



-OR-



### Natural Finish - with Seat Back

Length	Portable	In-Ground	Surface	UoM
7½'	PB-80	PB-80PI	PB-80SM	(EACH)
15'	PB-20	PB-20PI	PB-20SM	(EACH)
21'	PB-10	PB-10PI	PB-10SM	(EACH)
27'	PB-90	PB-90PI	PB-90SM	(EACH)

### Powder Coat - with Seat Back

Length	Portable	In-Ground	Surface	UoM
7½'	PB-80PC	PB-80PIPC	PB-80SMPC	(EACH)
15'	PB-20PC	PB-20PIPC	PB-20SMPC	(EACH)
21'	PB-10PC	PB-10PIPC	PB-10SMPC	(EACH)
27'	PB-90PC	PB-90PIPC	PB-90SMPC	(EACH)



-OR-

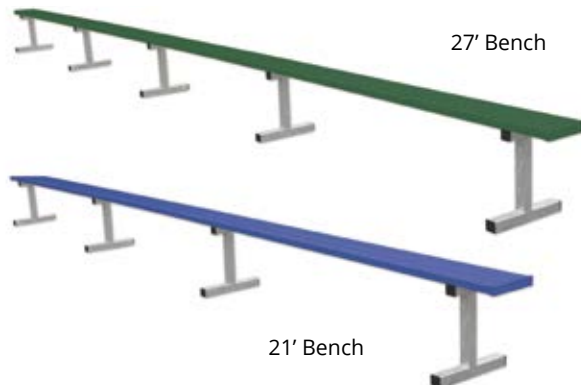

### Natural Finish - without Seat Back

Length	Portable	In-Ground	Surface	UoM
7½'	PB-75	PB-75PI	PB-75SM	(EACH)
15'	PB-15	PB-15PI	PB-15SM	(EACH)
21'	PB-5	PB-5PI	PB-5SM	(EACH)
27'	PB-95	PB-95PI	PB-95SM	(EACH)

### Powder Coat - without Seat Back

Length	Portable	In-Ground	Surface	UoM
7½'	PB-75PC	PB-75PIPC	PB-75SMPC	(EACH)
15'	PB-15PC	PB-15PIPC	PB-15SMPC	(EACH)
21'	PB-5PC	PB-5PIPC	PB-5SMPC	(EACH)
27'	PB-95PC	PB-95PIPC	PB-95SMPC	(EACH)

## PLAYER BENCH WITH SHELF



Durable rust-resistant aluminum bench with equipment shelf.

- 19" wide non-skid shelf for helmets, gloves, and other items
- Non-skid seat planks and rust-resistant steel legs
- 3 Year Limited Warranty

Specify plank colors when ordering powder coat option. Additional powder coat options available. (CALL)

### PLANK POWDER COAT COLORS:



-OR-



### Natural Finish

Length	Item	UoM
7½'	PBS-80	(EACH)
15'	PBS-20	(EACH)
21'	PBS-10	(EACH)
27'	PBS-90	(EACH)

### Powder Coat

Length	Item	UoM
7½'	PBS-80PC	(EACH)
15'	PBS-20PC	(EACH)
21'	PBS-10PC	(EACH)
27'	PBS-90PC	(EACH)

## SCORER TABLE WITH BENCH



Heavy-duty and rust-resistant. Ideal for any outdoor sport.

Specify plank colors when ordering powder coat option. Additional powder coat options available. (CALL)

- 10" wide non-skid seat planks and rust-resistant steel legs
- Tabletop - 7½'L x 19"W
- 3 Year Limited Warranty



-OR-



### Natural Finish

Length	Item	UoM
7½'	ST75	(EACH)

### Powder Coat

Length	Item	UoM
7½'	ST75PC	(EACH)



### COURTSIDE BENCHES



Portable 5' aluminum benches for courtside viewing.

- Durable and rust-resistant
- Single or double seat plank models
- Floor protection kit (PSS-4FT) for indoor use sold separately
- 3 Year Limited Warranty

Specify plank colors when ordering powder coat option.  
Additional powder coat options available. (CALL)

**PLANK POWDER COAT COLORS:**



-OR-



**Natural Finish - Single with Back**

**Powder Coat - Single with Back**

Length	Item	UoM
5'	PB40	(EACH)

Length	Item	UoM
5'	PB40PC	(EACH)



-OR-



**Natural Finish - Double Seat**

**Powder Coat - Double Seat**

Length	Item	UoM
5'	DPB50	(EACH)

Length	Item	UoM
5'	DPB50PC	(EACH)

### WALL-MOUNTED PLAYER BENCH



Rust-resistant aluminum bench ideal for locker rooms, aquatic centers, and outdoor applications.

- 10" wide non-skid seat planks
- Corrosion-resistant understructure
- 3 Year Limited Warranty

Specify plank colors when ordering powder coat option.



-OR-



**Natural Finish**

**Powder Coat**

Length	Item	UoM
7½'	PBW-75	(EACH)
15'	PBW-15	(EACH)
21'	PBW-5	(EACH)
27'	PBW-95	(EACH)

Length	Item	UoM
7½'	PBW-75PC	(EACH)
15'	PBW-15PC	(EACH)
21'	PBW-5PC	(EACH)
27'	PBW-95PC	(EACH)



For more  
information,  
scan or go to:  
[www.Jaypro.com/  
Bleachers](http://www.Jaypro.com/Bleachers)



# TIP & ROLL STANDARD BLEACHERS



Lightweight and stable aluminum bleachers tip-and-roll for easy mobility and storage.

- 10" wide non-skid seat planks with sturdy understructure
- Single or double foot plank models
- Non-marking 4" swivel casters
- Foot pad protectors prevent floor marking
- 3 Year Limited Warranty

*Low Rise Tip & Roll 4 row bleacher does not exceed 30" in height. Guard rails may not be needed (check local codes). Specify plank colors when ordering powder coat option. Additional powder coat options available. (CALL)*



Single Foot Plank



Back of Bleacher

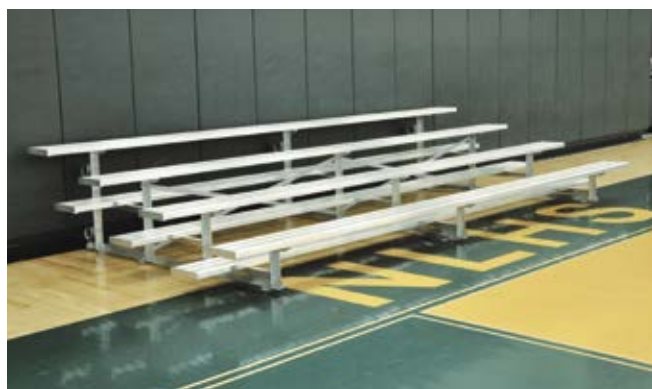

-OR-



## Natural Finish - Standard, Single Foot Plank

Rows	Length	Seats	Item	UoM
2	7½'	10	BLCH-275TRG	(EACH)
2	15'	20	BLCH-2TRG	(EACH)
2	21'	30	BLCH-221TRG	(EACH)
2	27'	38	BLCH-227TRG	(EACH)

3	7½'	15	BLCH-375TRG	(EACH)
3	15'	30	BLCH-3TRG	(EACH)
3	21'	42	BLCH-321TRG	(EACH)
3	27'	54	BLCH-327TRG	(EACH)

### Low Rise

4	7½'	20	BLCH-475TRG	(EACH)
4	15'	40	BLCH-4TRG	(EACH)
4	21'	52	BLCH-421TRG	(EACH)
4	27'	70	BLCH-427TRG	(EACH)

## Powder Coat - Standard, Single Foot Plank

Rows	Length	Seats	Item	UoM
2	7½'	10	BLCH-275TRGPC	(EACH)
2	15'	20	BLCH-2TRGPC	(EACH)
2	21'	30	BLCH-221TRGPC	(EACH)
2	27'	38	BLCH-227TRGPC	(EACH)

3	7½'	15	BLCH-375TRGPC	(EACH)
3	15'	30	BLCH-3TRGPC	(EACH)
3	21'	42	BLCH-321TRGPC	(EACH)
3	27'	54	BLCH-327TRGPC	(EACH)

### Low Rise

4	7½'	20	BLCH-475TRGPC	(EACH)
4	15'	40	BLCH-4TRGPC	(EACH)
4	21'	52	BLCH-421TRGPC	(EACH)
4	27'	70	BLCH-427TRGPC	(EACH)



# TIP & ROLL PREFERRED BLEACHERS



Double Foot Plank



BLDP-4TRG

**PLANK  
POWDER  
COAT  
COLORS:**



-OR-



## Natural Finish - Preferred, Double Foot Plank

Rows	Length	Seats	Item	UoM
2	7½'	10	BLDP-275TRG	(EACH)
2	15'	20	BLDP-2TRG	(EACH)
2	21'	30	BLDP-221TRG	(EACH)
2	27'	38	BLDP-227TRG	(EACH)

3	7½'	15	BLDP-375TRG	(EACH)
3	15'	30	BLDP-3TRG	(EACH)
3	21'	42	BLDP-321TRG	(EACH)
3	27'	54	BLDP-327TRG	(EACH)

### Low Rise

4	7½'	20	BLDP-475TRG	(EACH)
4	15'	40	BLDP-4TRG	(EACH)
4	21'	52	BLDP-421TRG	(EACH)
4	27'	70	BLDP-427TRG	(EACH)

## Powder Coat - Preferred, Double Foot Plank

Rows	Length	Seats	Item	UoM
2	7½'	10	BLDP-275TRGPC	(EACH)
2	15'	20	BLDP-2TRGPC	(EACH)
2	21'	30	BLDP-221TRGPC	(EACH)
2	27'	38	BLDP-227TRGPC	(EACH)

3	7½'	15	BLDP-375TRGPC	(EACH)
3	15'	30	BLDP-3TRGPC	(EACH)
3	21'	42	BLDP-321TRGPC	(EACH)
3	27'	54	BLDP-327TRGPC	(EACH)

### Low Rise

4	7½'	20	BLDP-475TRGPC	(EACH)
4	15'	40	BLDP-4TRGPC	(EACH)
4	21'	52	BLDP-421TRGPC	(EACH)
4	27'	70	BLDP-427TRGPC	(EACH)

# ALL ALUMINUM STANDARD BLEACHER

Lightweight all aluminum bleachers are perfect for outdoor parks and fields.



- 10" wide non-skid seat planks with sturdy understructure
- Single or double foot plank models
- Indoor conversion kit (BLCHICK34) for indoor use sold separately

- 3 Year Limited Warranty

*Low Rise 4 row bleacher does not exceed 30" in height. Guard rails may not be needed (check local codes). Specify plank colors when ordering powder coat option. Additional powder coat options available. (CALL)*



-OR-



## Natural Finish - Standard, Single Foot Plank

Rows	Length	Seats	Item	UoM
3	15'	30	BLCH-3AL	(EACH)
3	21'	42	BLCH-321AL	(EACH)
3	27'	54	BLCH-327AL	(EACH)

## Low Rise

4	15'	40	BLCH-4AL	(EACH)
4	21'	52	BLCH-421AL	(EACH)
4	27'	70	BLCH-427AL	(EACH)

## Powder Coat - Standard, Single Foot Plank

Rows	Length	Seats	Item	UoM
3	15'	30	BLCH-3ALPC	(EACH)
3	21'	42	BLCH-321ALPC	(EACH)
3	27'	54	BLCH-327ALPC	(EACH)

## Low Rise

4	15'	40	BLCH-4ALPC	(EACH)
4	21'	52	BLCH-421ALPC	(EACH)
4	27'	70	BLCH-427ALPC	(EACH)



# ALL ALUMINUM PREFERRED BLEACHER



-OR-



## Natural Finish - Preferred, Double Foot Plank

Rows	Length	Seats	Item	UoM
3	15'	30	BLDP-3AL	(EACH)
3	21'	42	BLDP-321AL	(EACH)
3	27'	54	BLDP-327AL	(EACH)

### Low Rise

4	15'	40	BLDP-4AL	(EACH)
4	21'	52	BLDP-421AL	(EACH)
4	27'	70	BLDP-427AL	(EACH)

## Powder Coat - Preferred, Double Foot Plank

Rows	Length	Seats	Item	UoM
3	15'	30	BLDP-3ALPC	(EACH)
3	21'	42	BLDP-321ALPC	(EACH)
3	27'	54	BLDP-327ALPC	(EACH)

### Low Rise

4	15'	40	BLDP-4ALPC	(EACH)
4	21'	52	BLDP-421ALPC	(EACH)
4	27'	70	BLDP-427ALPC	(EACH)

PLANK  
POWDER  
COAT  
COLORS:



RED



NAVY  
BLUE



YELLOW



GOLD



GRAY



BLACK



MAROON



DARK  
GREEN



KELLY  
GREEN



ROYAL  
BLUE



ORANGE



PURPLE

## PROTECT INDOOR SURFACES

### FLOOR PROTECTION KIT

- Prevents floor marking
- 4 rubber feet and self-threading screws included
- For use with player benches

PSS-4FT (KIT)



### INDOOR CONVERSION KIT



Protect floor surfaces with this outdoor to indoor bleacher conversion kit.

- 12 rubber pad protectors to prevent floor marking
- 7½' Bleacher - Requires 1 kit; 15'/21' Bleacher - Requires 2 kits; 27' Bleacher - Requires 3 kits
- 3 Year Limited Warranty

*For 2, 3, and 4 row bleachers at lengths of 7½', 15', 21', and 27'.*

BLCHICK34 (SET)



# BACK-TO-BACK STANDARD BLEACHER

Place between adjoining fields or indoor courts for spectator viewing from both sides of the bleacher.



- 10" wide non-skid seat planks with sturdy understructure
- Single or double foot plank models
- Indoor conversion kit (BLCHICK34) for indoor use sold separately

- 3 Year Limited Warranty

*Specify plank colors when ordering powder coat option. Additional powder coat options available. (CALL)*



-OR-



**Natural Finish - Standard, Single Foot Plank**

Rows	Length	Seats	Item	UoM
3	7½'	25	BTBB-375	(EACH)
3	15'	50	BTBB-3	(EACH)
3	21'	72	BTBB-321	(EACH)

**Powder Coat - Standard, Single Foot Plank**

Rows	Length	Seats	Item	UoM
3	7½'	25	BTBB-375PC	(EACH)
3	15'	50	BTBB-3PC	(EACH)
3	21'	72	BTBB-321PC	(EACH)



-OR-



**Natural Finish - Preferred, Double Foot Plank**

Rows	Length	Seats	Item	UoM
3	7½'	25	BTDP-375	(EACH)
3	15'	50	BTDP-3	(EACH)
3	21'	72	BTDP-321	(EACH)

**Powder Coat - Preferred, Double Foot Plank**

Rows	Length	Seats	Item	UoM
3	7½'	25	BTDP-375PC	(EACH)
3	15'	50	BTDP-3PC	(EACH)
3	21'	72	BTDP-321PC	(EACH)

**PLANK POWDER COAT COLORS:**



# STANDARD OUTDOOR BLEACHER

Heavy-duty outdoor bleacher with dual braces and rear stabilizing bar for increased strength.



- 10" wide aluminum non-skid seat planks
- Galvanized steel understructure
- 3 Year Limited Warranty

*Low Rise 4 row bleacher does not exceed 30" in height. Guard rails may not be needed (check local codes). Specify plank colors when ordering powder coat option. Additional powder coat options available. (CALL)*



-OR-

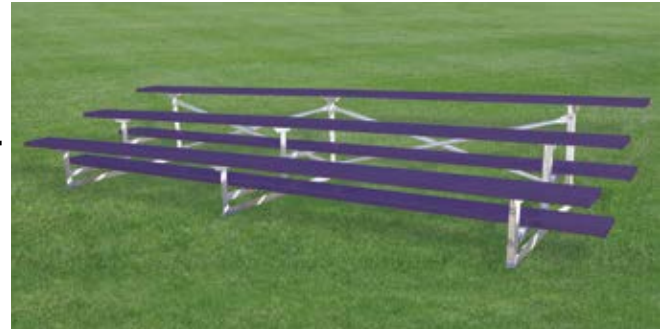

## Natural Finish - Standard, Single Foot Plank

Rows	Length	Seats	Item	UoM
3	15'	30	BLCH-3	(EACH)
3	21'	42	BLCH-321	(EACH)
3	27'	54	BLCH-327	(EACH)

### Low Rise

4	15'	40	BLCH-4	(EACH)
4	21'	52	BLCH-421	(EACH)
4	27'	70	BLCH-427	(EACH)

## Powder Coat - Standard, Single Foot Plank

Rows	Length	Seats	Item	UoM
3	15'	30	BLCH-3PC	(EACH)
3	21'	42	BLCH-321PC	(EACH)
3	27'	54	BLCH-327PC	(EACH)

### Low Rise

4	15'	40	BLCH-4PC	(EACH)
4	21'	52	BLCH-421PC	(EACH)
4	27'	70	BLCH-427PC	(EACH)



## BLEACHER/BENCH PLANK PAD

Create comfortable bleacher seating for spectators.

- Straps buckle under plank for easy installation
- 7'L x 10"W x 1 3/8"H
- 1 Year Limited Warranty

*Specify pad color when ordering (Pink, Lime, Kelly Green, Light Blue, Royal Blue, Forest Green, Yellow, Orange, Dark Purple, Burgundy, Beige, Brown, Navy Blue, Red, Gray, Charcoal or Black). Call for freight quote (extended lead time may apply).*

**Custom - non-returnable.**

PLKPAD7 (EACH)



## BLEACHER TRANSPORT KIT

Transport bleachers from field to field with ease.

- (2) 4"W x 12"H heavy-duty wheels
- Wheels and tongue easily attach and remove
- Fits any angle framed 2, 3, 4, or 5 row bleachers at lengths of 15', 21', and 27'
- Comes complete to fit one bleacher
- Additional wheel mounting brackets available to allow wheels to be used on multiple bleachers

**15'** BLCH-TOW4515 (KIT)

**21'- 27'** BLCH-TOW4521 (KIT)

**Add. Wheel Mounting Kit** BLCH-TMKIT (KIT)

# ENCLOSED BLEACHER

Heavy-duty enclosed bleacher with dual braces and rear stabilizing bar for increased strength.



- 10" wide aluminum non-skid seat planks
- Galvanized steel understructure
- Vertical guardrails or chain-link enclosure
- 5 or 10 row configuration
- Aisle option includes handrail in center of bleacher
- 3 Year Limited Warranty

*Specify plank colors when ordering powder coat option. Additional powder coat options available. (CALL) Powder coat finish not available on chain-link, guardrail enclosures or 10 row bleachers. Call for freight quote.*



-OR-



## Natural Finish - Guard Rail

Rows	Length	Seats	Item	UoM
5	15'	50	BLCH-5GR	(EACH)
5	21'	62	BLCH-521GR	(EACH)
5	27'	80	BLCH-527GR	(EACH)
10	15'	100	BLCH-10GR	(EACH)
10	21'	140	BLCH-1021GR	(EACH)
10	27'	170	BLCH-1027GR	(EACH)

## Powder Coat - Guard Rail

Rows	Length	Seats	Item	UoM
5	15'	50	BLCH-5GRPC	(EACH)
5	21'	62	BLCH-521GRPC	(EACH)
5	27'	80	BLCH-527GRPC	(EACH)

## Natural Finish - Guard Rail with Aisle

Rows	Length	Seats	Item	UoM
5	21'	58	BLCH-521ASGR	(EACH)
10	21'	114	BLCH-1021ASGR	(EACH)
10	27'	134	BLCH-1027ASGR	(EACH)

## Powder Coat - Guard Rail with Aisle

Rows	Length	Seats	Item	UoM
5	21'	58	BLCH-521ASGRPC	(EACH)

PLANK  
POWDER  
COAT  
COLORS:







**Natural Finish - Chain Link**

Rows	Length	Seats	Item	UoM
5	15'	50	BLCH-5C	(EACH)
5	21'	62	BLCH-521C	(EACH)
5	27'	80	BLCH-527C	(EACH)

**Powder Coat - Chain Link**

Rows	Length	Seats	Item	UoM
5	15'	50	BLCH-5CPC	(EACH)
5	21'	62	BLCH-521CPC	(EACH)
5	27'	80	BLCH-527CPC	(EACH)

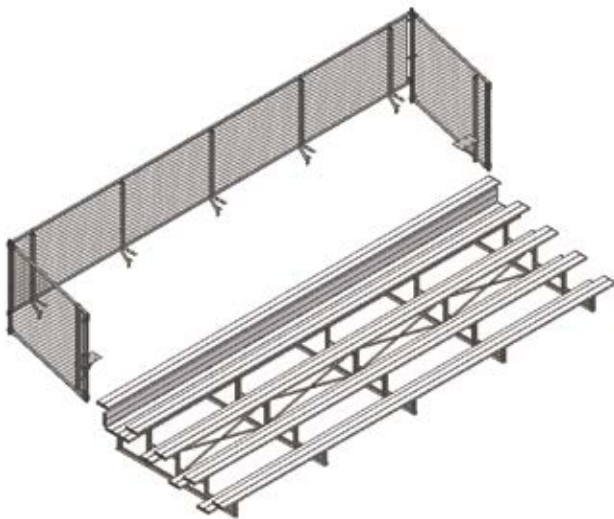

**UNIVERSAL ENCLOSURE**



Upgrade 5 row bleachers to comply with local safety codes.

- Enclose bleacher seating higher than 30" (fits most bleacher brands)
- Bolts to 5 row bleachers at lengths of 15', 21', and 27'
- Footboard, kickboard, attachment frame, and hardware kit included
- 3 Year Limited Warranty

<b>15' - 5 Row</b>	BLCH5CUE15 (EACH)
<b>21' - 5 Row</b>	BLCH5CUE21 (EACH)
<b>27' - 5 Row</b>	BLCH5CUE27 (EACH)

**JAYPRO SPORTS ONLINE**

Jaypro Sports is a leading authority for institutional sports equipment and athletic field/facility solutions. Our customers know they can count on Jaypro Sports to deliver when it comes to product quality and safety, industry knowledge, and reliable service.

Visit us online at [www.Jaypro.com](http://www.Jaypro.com) to purchase, get a quote or research all your sporting goods needs.





# QUICK INDEX

Archery.....	166	Storage Carts.....	127	Nets.....	72-73	Wheel Kits.....	35
Backboards, Basketball.....	112-115	Straight Post Systems.....	138-139	Training.....	71	Storage & Transport	
Backstop Padding.....	104	Wall-Mounted Backstops.....	122-123	Netting, Protective		Ball Carts.....	168-171
Badminton Posts/Net.....	189	Wall-Mounted Shooting Stations.....	124	Custom.....	148	Baseball/Softball.....	96-97
Ball Storage.....	168-171	Beach Volleyball System.....	12	Motorized.....	148	Basketball.....	127
Baseball/Softball.....	74-105	Benches, Player.....	190-192	Outdoor.....	172-175	Bike Racks.....	167
Base Anchors.....	96	Bleachers.....	194-201	Perimeter, Indoor.....	148	Football.....	64
Backstops.....	87	Bleachers, Enclosed.....	200-201	Portable.....	175	Gymnasium.....	154
Backstop Padding.....	104	Bike Racks.....	167	Nets		Lacrosse.....	70
Ball Cart.....	97	Discus Cage.....	179	Baseball/Softball.....	83	Soccer.....	35, 52
Base Cart.....	96	Divider Curtains.....	144-147	Basketball.....	120	Track & Field.....	178
Bases.....	95-96	Dry Line Markers.....	106-107	Field Hockey.....	67	Volleyball.....	15, 19, 22
Batters Box Template.....	100	Equipment Controllers.....	149	Lacrosse.....	72-73	Tennis.....	182-189
Batting Cages/Accessories.....	74-79	Facilities.....	144-159	Pickleball.....	188	Accessories.....	189
Batting Tunnels, Indoor.....	84	Field Covers/Tarps.....	102	Protective.....	172-175	Benches.....	192
Batting Tunnels, Mounting Kits.....	85	Field Grooming.....	100-101	Soccer.....	50	Nets.....	188
Batting Tunnels, Outdoor.....	80-82	Field Hockey.....	67	Tennis.....	189	Posts.....	182-187
Batting Tunnel Nets.....	83	Field Marking.....	106-107	Volleyball.....	16-17	Wind Screen.....	189
Fence Protection.....	105	Field Netting.....	172-175	Padding		Tetherball.....	164
Field Covers/Tarps.....	102	Field Hockey.....	166	Basketball.....	142-143	Track & Field.....	176-181
Field Grooming.....	100-101	Floor Sleeves		Bleachers.....	194-201	Cages.....	179
Field Markers/Strippers.....	106-107	Badminton.....	189	Football.....	61	Circles.....	180
Field Marking Systems.....	107	Pickleball.....	187	Rugby.....	41	Crossbars.....	176-177
Foul Poles.....	88-89	Volleyball.....	20	Volleyball.....	14	High Jump Standards/Pits.....	177
Game Mounds.....	98-99	Football.....	56-66	Wall Pads, Indoor.....	155-158	Hurdles.....	178
Home Plates.....	94-95	Accessories.....	63	Wall Pads, Outdoor.....	104	Pole Vault Standards/Pits.....	176
Marking Dust.....	106	Ball Stop System.....	60	Physical Education.....	162-167	Sand Pit Forms.....	181
Mound/Base Covers.....	102	Chutes.....	65	Pickleball.....	185-187	Starting Blocks.....	178
Outfield Batters Eye.....	103	Goal Posts.....	56-59	Pitcher Screens.....	90-93	Take Off/Toe Boards.....	181
Paint, Field Marking.....	107	Goal Posts, H-Frame.....	41	Player Benches.....	190-192	Vault Boxes.....	180
Pitcher Rubbers.....	94	Goal Posts, Overhead.....	60	Portable Basketball Systems.....	108-111	Turf.....	86
Pitching Machines.....	86	Ground Sleeves.....	57, 59	Post Pads, Basketball.....	142-143	Volleyball.....	2-23
Pitching Mounds.....	98-99	Kicking Cages.....	64	Post Pads, Football.....	61	Anchors.....	21
Protector Nets.....	87	Padding.....	61	Post Pads, Volleyball.....	10, 14	Antenna.....	22
Protector Screens.....	90-93	Storage Racks.....	64	Protective Screens,		Ball Carts.....	22
Rail Padding.....	105	Training.....	62, 65-66	Baseball/Softball.....	90-93	Beach Volleyball System.....	12
Storage Racks.....	97	Foul Poles.....	88-89	Rims.....	116-119	Floor Sleeves.....	20
Turf.....	86	Futsal Goals.....	44	Rugby Goal/Padding.....	41	Nets.....	16-17
Wall & Fence Padding.....	104	Game Standards.....	162-165	Scoreboards.....	160-161	Outdoor Systems.....	12-13
Wind Screen.....	103	Ground Anchors		Scorer Tables.....	129, 191	Overhead System.....	11
Basketball/Gymnasium.....	108-143	Soccer.....	48-49	Shelters.....	42-43	Padding.....	14
Adjustable Systems.....	130-131	Ground Sleeves		Shot/Discus Circles.....	180	Referee Stands.....	18-19
Backboard Padding.....	121	Baseball/Softball.....	88-89	Soccer.....	24-55	Storage Carts.....	19
Backboards.....	112-115	Football.....	57, 59	Accessories.....	53-54	Storage Racks.....	19
Backboard Adapters.....	126	Soccer.....	33-34, 38-39	Anchors.....	48-49	Training.....	23
Backstop Height Adjusters.....	125	Tennis.....	183-184	Ball Stop System.....	27	Uprights/Systems.....	2-10
Fixed Height Systems.....	132-134	Height Adjusters.....	125	Combo Goals, Soccer/Football.....	38-41	Wall Pads.....	104, 155-158
Goals/Rims.....	116-119	Lineman Chutes.....	65	Futsal Goals.....	44	Winches.....	150-151
Gooseneck Systems.....	136-137	Lacrosse.....	68-73	Goals, Official/Club.....	24-37	Wind Screen.....	103, 189
Hoop Rejuvenator Kits.....	140-141	Ball Stop Systems.....	71, 174	Goals, Practice/Training.....	45-47	Wrestling Mat Storage.....	153
Nets.....	120	Field ID Markers.....	71	Nets.....	50		
Padding.....	142-143	Goals, Box/Field.....	68-70	Rebounders.....	52		
Portable Systems.....	108-111	Goal Cart.....	70	Shelters.....	42-43		

## TERMS & CONDITIONS

### Contact your Local Jaypro Sports Representative or Jaypro Sports for detailed information on Terms & Conditions

**Returns:** Jaypro Sports will accept the authorized return of all standard products for any reason within 30 days of the ship date. SPECIAL ORDER/ CUSTOM COLOR ITEMS ARE NOT RETURNABLE. Customers must obtain a return authorization number from Jaypro Sports after supplying the invoice number, item number, and reason for return. Customer is responsible for a 25% restocking fee and return freight charges.

**Freight Damages & Discrepancies:** Damages or shortages must be reported within 7 days of the delivery date. It is the responsibility of the customer to sign the delivery receipt as damaged or short. If Jaypro Sports is notified within this time frame, we will replace as needed and file the claim with the carrier.

**Payment Terms:** We accept checks, American Express, Discover, MasterCard, and Visa. Approved accounts are required to submit a purchase order and will be billed Net 30 from the invoice date. All past due accounts are subject to a 1.5% per month (18% per year) interest charge and collection costs. Any approved account choosing to pay by credit card after the invoice date may be subject to a 3% credit card processing fee.

**Warranties:** Limited Warranty: Jaypro warrants most of our products against defects in workmanship and material for three years from the date of shipment, unless otherwise noted in the catalog.

*We reserve the right to correct typographical errors. Visit [www.Jaypro.com](http://www.Jaypro.com) for a full list of Terms & Conditions.*





JAYPRO SPORTS IS  
GOING GREEN

Use your mobile device to scan this code  
and download our digital catalogs.



Contact your Local Jaypro Sports Dealer Today

**Place Dealer Label Here**

Jaypro Sports LLC  
Phone: (Toll Free)

800-243-0533  
860-447-3001

Fax: (Toll Free)

800-988-3363  
860-444-1779

- Dealer Rated BEST in Customer Service
- Multi-Year Warranties
- Trusted for Decades

## EXCEPTIONAL EQUIPMENT FOR EXCEPTIONAL FACILITIES

Jaypro Sports has been a leading authority for institutional sports equipment since 1953. A wealth of experience is engineered and manufactured into each piece of equipment supplied to the best projects in the industry.

[www.Jaypro.com](http://www.Jaypro.com)



DESIGNED TO PERFORM. MANUFACTURED TO LAST.