

JOIN OUR GAME



JUG
ATHLETICS

CUSTOM

STYLE

PERFORMANCE



JOIN OUR GAME

JOG is Join Our Game -- an idea built on inclusivity, not exclusivity. We're as much about small town teams with big dreams as we are about big time teams who leave it all on the ice, field or court. We believe every player deserves a quality jersey with a custom look that makes them feel like a pro.

JOG is driven to exceed our customers expectations with a better jersey buying experience through complete customization, professional sustainable quality and personal interaction at a price all teams can afford.

Your look, done right.
Join our Game.



INDEX

Replay Series	4
Hockey Fabric Descriptions	5
Colors	6
Collar Styles and Size Chart	8
Number Fonts	10
Name Fonts	11
The Premier Jersey	12
Revolutionary Hybrid Jersey	13
Tempo Hybrid Jersey	14
Deluxe Styles	15
Standard Styles	20
Tempo Hybrid Styles	22
Replica Jersey	28
Innovator Sublimation Jersey	29
Innovator Sublimation Styles	30
Special Occasion Jerseys	32
Special Occasion Styles	33
Eco-Primo Reversible Jersey	36
Reversible Training Jersey	37
Reversible Styles	38
Training Jerseys	40
Training Styles	41
Tuff Shell Pants	42
Tuff Shell Pant Styles	43
Hockey Bags	44
Hockey Bag Straps	45
Hockey Socks	46

Apparel Size Chart	47
Grinde Series	48
Apparel Fabric Descriptions	49
Jackets	50
Jacket Styles	51
Everest Surge Jacket	52
Everest Surge Jacket Styles	53
Tracksuits	54
Tracksuit Styles	55
Hoodies	56
Hoodie Styles	57
Joggers	59
Jogger Styles	60
Polos	61
Polo Styles	62
Shorts	63
Short Styles	64
Shirts	65
Shirt Styles	66
Hats and Beanies	67

REPLAY

REPLAY

REPURPOSE

RENEW

REACT

ECO-FRIENDLY PRODUCTS



Our planet is facing unprecedented sustainability challenges and JOG aims to be part of the solution. We're proud to be at the forefront of producing eco-friendly sports apparel with our REPLAY Series.

We collaborate with companies that upcycle PET bottles and restyle the plastic into usable thread. This thread remains the bedrock of our many innovative fabrics designed for high level performance, durability, and comfort. We are committed to providing superior quality products while helping to create a more sustainable environment for future athletes.



HOCKEY FABRIC DESCRIPTIONS

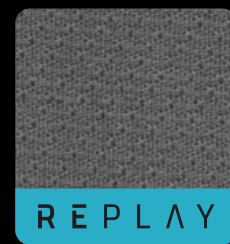

Air Knit Pro
 100% Recycled Polyester (220g/m²)
 Constructed for durability, breathability, and performance.
 Application: Pro weight game jerseys and mid weight practice socks
 Preferred level use: All levels and leagues

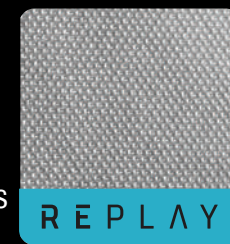

Endurance Pro PK
 37.5% Recycled Polyester
 62.5% Polyester (270g/m²)
 Higher yarn count for durability and enhanced performance against pilling.
 Application: Pro weight game socks



Air Knit Pro Max
 50% Recycled Polyester,
 50% Polyester (235g/m²)
 Constructed for durability, breathability, and performance.
 Application: Pro weight game jerseys
 Preferred Level Use: AAA Level, High School, Junior, Collegiate, Pro level teams

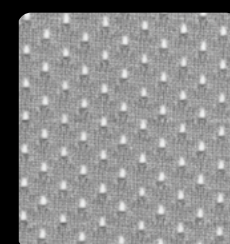

Poly-Pro Mesh
 100% Polyester (260g/m²)
 Provides increased durability, breathability, and performance.
 Application: Mesh inserts for game jerseys and socks



Air Knit Pro "X"
 50% Recycled Polyester,
 50% Polyester (205g/m²)
 Similar performance and texture as AK Pro Max but lighter weight.
 Application: Sublimated jerseys
 Preferred Level Use: All levels and leagues

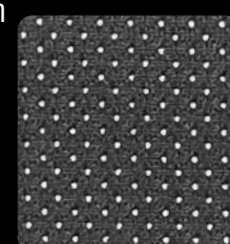

Poly-Pro Stretch Mesh
 90% CD Polyester, 10% Spandex (280g/m²)
 Application: Mesh insert for game jerseys and socks

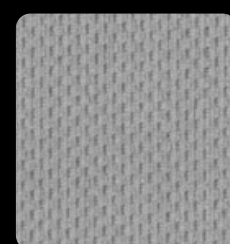

Dura Light and Plus
 100% Poly Birdseye Mesh (152g/m² -160g/m²)
 Lightweight yet durable with anti-snagging functionality.
 Application: Practice jerseys, reversible jerseys, lightweight practice and game socks

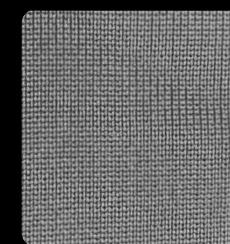

RIB
 95% Polyester, 5% Spandex
 Stretch material
 Application: Stretch zones for shell pants

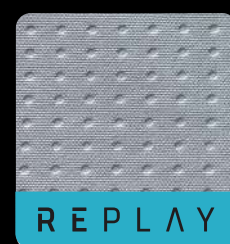

Concave Pro Emboss
 39% Recycled Polyester and 61% Polyester (160g/m²)
 Durable and breathable with embossed dot pattern.
 Application: Optional pro weight game jersey shoulders

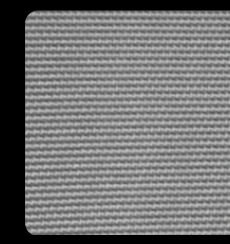

Tuff Shell
 840D Nylon
 Strong material, abrasion resistant.
 Application: Pro shell pants



VaporICE Laser
 100% Recycled PET birdseye mesh (220g/m²)
 Constructed for comfort and breathability.
 Application: Sublimated replica jerseys

PMS 3308C FOREST GREEN	PMS 7484C DARK GREEN	PMS 3425C DALLAS GREEN	PMS 365C KELLY GREEN	PMS 802C NEON GREEN	PMS 902C MISSION GREEN
PMS 7715C TEAL	PMS 319C PRO BLUE GREEN	PMS 2171C POWDER BLUE	PMS 2142C COLUMBIA BLUE	PMS 2384C FINLAND BLUE	PMS 648C TORNOTO BLUE
PMS 287C VARSITY ROYAL	PMS 2758C DARK ROYAL	PMS 282C DARK NAVY	PMS 274C KINGS PURPLE	PMS 3566C PURPLE	PMS 2645C LIGHT PURPLE
PMS 212C HOT PINK	PMS 7645C MAROON	PMS 195C CARDINAL	PMS 7638C 49ERS RED	PMS 201C SCARLET RED	PMS 200C UNIVERSITY RED
PMS 7417C DARK ORANGE	PMS 804C NEON ORANGE	PMS 021C ORANGE	PMS 7549C VARSITY GOLD	PMS 7409C LIGHT GOLD	PMS 109C MICHIGAN MAIZE
PMS 102C YELLOW	PMS 7506C CREAM	PMS 7527C VINTAGE CREAM	PMS 468C DUST GOLD	PMS 4525C LIGHT VEGAS GOLD	PMS 466C NUGGET GOLD
PMS 439C BROWN	BLACK	PMS 7540C KNIGHTS GREY	COOL GREY 9C MID GREY	PMS 5295C GREY	PMS 429C PRO SILVER
WHITE					

FABRICS	HOCKEY						SHELL PANT	
	Air Knit Pro	Air Knit Pro Max	Endurance -PK	Poly Pro Mesh	Dura Light	Poly Pro Stretch Mesh	Tuff Shell	Rib
FOREST GREEN								
DARK GREEN								
DALLAS GREEN								
KELLY GREEN								
NEON GREEN								
MISSION GREEN								
TEAL								
TORONTO BLUE								
FINLAND BLUE								
COLUMBIA BLUE								
POWDER BLUE								
PRO BLUE GREEN								
LIGHT PURPLE								
PURPLE								
KINGS PURPLE								
DARK ROYAL								
VARSITY ROYAL								
DARK NAVY								
HOT PINK								
MAROON								
CARDINAL								
49ERS RED								
SCARLET RED								
UNIVERSITY RED								
DARK ORANGE								
ORANGE								
NEON ORANGE								
VARSITY GOLD								
LIGHT GOLD								
MICHIGAN MAIZE								
YELLOW								
CREAM								
VINTAGE CREAM								
LIGHT VEGAS GOLD								
DUST GOLD								
NUGGET GOLD								
BROWN								
BLACK								
KNIGHTS GREY								
MID GREY								
GREY								
PRO SILVER								
WHITE								

COLLARS AND SIZE CHART

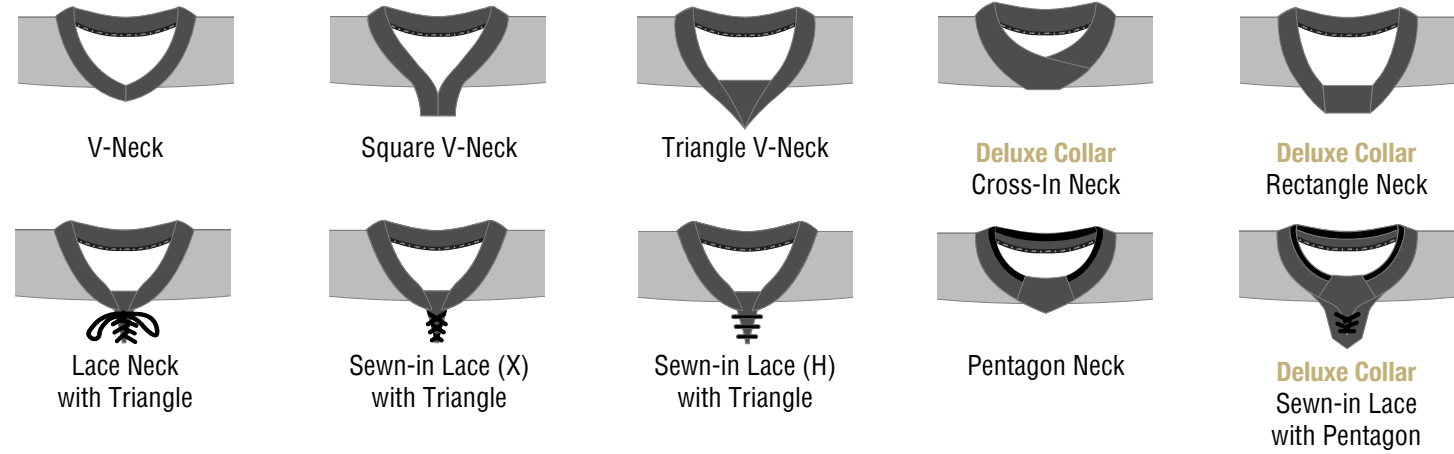

HOW TO MEASURE:

Lay your jersey flat.

1. Chest Width (A): Measure from one inch under the armpits of the jersey horizontally from seam to seam. (e.g. An adult large jersey will measure 26" across (under the arms) on one side of the jersey, which will be 52 inches all around for an AL-52 size.)

2. Sleeve Length (B): Measure from the edge of the collar all the way to the end of the wrist.

3. Jersey Length (C): Measure from the bottom of the back collar to the center bottom back of the jersey.

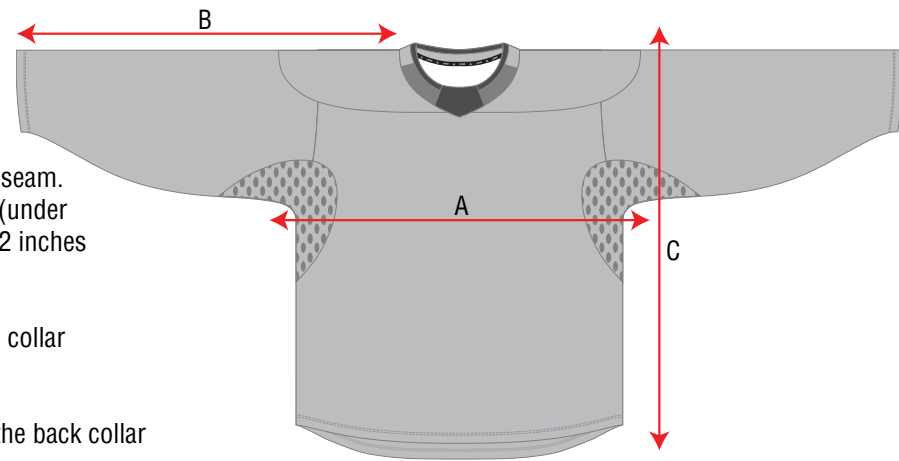

PLEASE USE THIS CHART AS A GENERAL GUIDE; SIZES VARY SLIGHTLY BY JERSEY STYLE.

		Hockey Jersey (Player)							Hockey Jersey (Goalie)						
ADULT SIZING		AS-48	AM-50	AL-52	AXL-54	A2XL-56	A3XL-58	A4XL-60	GC-52 (AS)	GC-54 (AM)	GC-56 (AL)	GC-58 (AXL)	GC-60 (A2XL)	GC-62 (A3XL)	GC-64 (A4XL)
A	Chest Width	24	25	26	27	28	29	30	26	27	28	29	30	31	32
B	Sleeve Length	27	29	30	31	32	33	33	28	29	30	31	32	33	33.5
C	Body Length	30	31	32	33	34	35	35.5	30	31	32	33	34	35	35.5

		Hockey Jersey (Player)						Hockey Jersey (Goalie)			
YOUTH SIZING		CHILD-36	YXS-38	YS-40	YM-42	YL-44	YXL-46	GC-44 (YS)	GC-46 (YM)	GC-48 (YL)	GC-50 (YXL)
A	Chest Width	17.5	19	20	21	22	23	22	23	24	25
B	Sleeve Length	20.5	21.5	23.5	24.5	25.5	26.5	24	25	26	27
C	Body Length	23	24	26	27	28	29	26	27	28	29

		Hockey Jersey (Player)						Hockey Jersey (Goalie)	
WOMEN'S SIZING (Team orders only)		YL-42	AXS-44	AS-46	AM-48	AL-50	AXL-52	GC-56	GC-58
A	Chest Width	21	22	23	24	25	26	28	29
B	Sleeve Length	25	26	27	28	29	30	28	29
C	Body Length	26	27	28	29	30	31	30	31

This chart reflects sizing for use with equipment. If you're wearing JOG jerseys for casual wear, we suggest you order 1-2 sizes smaller. For larger orders Replica cuts are available. Please see page 28 for more details.

NAME + NUMBER STYLES

PRO TWILL
Letters/Numbers are laser cut from twill and stitched onto jerseys or nameplates; professional sports method.

SCREEN PRINT
Letters/Numbers are adhered directly onto garments using ink and cured using heat; Pro Block only.

SUBLIMATION
Letters/Numbers are transferred directly onto garments using a dye printing process and heat; most customizable.



BACK NUMBERS : 8" 10" 12" OR CUSTOM
SLEEVE NUMBERS : 3" 3.5" 4" OR CUSTOM

ASK YOUR SALES REP ABOUT CUSTOM FONT AND NUMBERS.

1 COLOR PRO TWILL

PRO BLOCK
1234567890

NHL CHICAGO
1234567890

BUREAU
1234567890

2 COLOR PRO TWILL

PRO BLOCK
1234567890

GUN PLAY
1234567890

NHL NEW YORK RANGERS OUTLINE
1234567890

3 COLOR PRO TWILL

PRO BLOCK
123457890

NHL EDGE MINNESOTA HOME
1234567890

NHL ST LOUIS
1234567890

1 COLOR SUBLIMATED

AGENCY BOLD
1234567890

SUPERSTAR M54
1234567890

BEBAS
1234567890

2 COLOR SUBLIMATED

MILITARY FONT 7
1234567890

BURGHY
1234567890

NHL MINNESOTA
1234567890

3 COLOR SUBLIMATED

JERSEY M54
1234567890

NHL PREDATORS
1234567890

LA KINGS
1234567890

SUBLIMATION NAMEBAR

Names are sublimated onto a namebar that matches the jersey color.

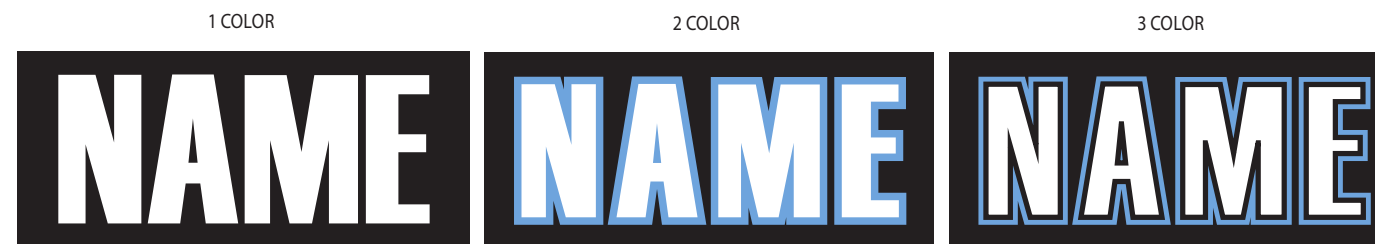

NAME : 2.5" 3" OR CUSTOM

PRO TWILL NAMES

HAETTENSCHWEILER
A B C D E F G H I J K L M N O P Q R S T U V W X Y Z

NHL 76 ERS
A B C D E F G H I J K L M N O P Q R S T U V W X Y Z

NHL CHICAGO
A B C D E F G H I J K L M N O P Q R S T U V W X Y Z

FRESHMAN
A B C D E F G H I J K L M N O P Q R S T U V W X Y Z

HAETTENSCHWEILER
A B C D E F G H I J K L M N O P Q R S T U V W X Y Z

NHL CHICAGO
A B C D E F G H I J K L M N O P Q R S T U V W X Y Z

SUBLIMATED NAMES

HAETTENSCHWEILER
A B C D E F G H I J K L M N O P Q R S T U V W X Y Z

NHL CHICAGO
A B C D E F G H I J K L M N O P Q R S T U V W X Y Z

MILITARY FONT 7
A B C D E F G H I J K L M N O P Q R S T U V W X Y Z

AGENCY FB
A B C D E F G H I J K L M N O P Q R S T U V W X Y Z

BEBAS
A B C D E F G H I J K L M N O P Q R S T U V W X Y Z

JERSEY M54
A B C D E F G H I J K L M N O P Q R S T U V W X Y Z

Classic Cut & Sew Jersey



Style #2810

Modern Sublimated Base Layer with Classic Logo/Name/Numbers



Style #1444



Custom Neck Collar Options



Pro Tackle Twill Logos



Cut and Sew Stripes



Double Material Support



Custom Neck Collar Options



Pro Tackle Twill Logos

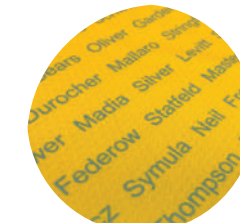

Sublimated Jersey Base

The Premier Hockey Jersey is JOG's top-of-the-line jersey; a truly custom-made cut and sew jersey with tackle twill and embroidery appliques. This jersey has all the extras and there are no additional fees for double material in the shoulders and elbows, single-needle cover seam stitching, collar support binding, mesh inserts and a variety of neck closures. This is a high performance, professional level jersey. Available in Deluxe and Standard Styles.

The Revolutionary Hybrid Jersey offers the ultimate in customization. The sublimated base jersey offers endless options for specific pantone colors and graphics while keeping the pro-level look of our Premier Jersey with tackle twill and embroidery appliques. Lightweight and durable, this is the jersey for teams who want to level up their look!

Fabric Options

- Air Knit Pro Max (235 g/m²)
- Air Knit Pro (220 g/m²)
- Poly-Pro Mesh (260 g/m²)



Fabric Options

- Air Knit Pro Max (235 g/m²)
- Air Knit Pro (220 g/m²)
- Air Knit Pro X (205 g/m²)
- Poly-Pro Mesh (260 g/m²)



Classic Cut & Sew with Sublimated Stripes and/or Shoulder Yokes

Single / Double Needle Stitch
In Collar and Body

Option for Sublimated Yoke with Logos

Custom Collar / Neck Options

Pro Tackle Twill Logos

Pro Tackle Twill Names
Pro Tackle Twill Numbers on Back and Arms

Double Material Support Elbows and Shoulders

NEW Sublimated Stripes

Style #2755



Custom Neck Collar Options



Pro Tackle Twill Logos



Sublimated Stripes



Optional Sublimated Shoulder Yokes

The Tempo Hybrid Jersey is the newest addition to our hybrid line-up. The jersey is top-of-the-line, offering tackle twill and embroidery appliques with sublimated striping and/or shoulder yokes. This option becomes essential with jersey designs that call for twill logos and requires complex striping. When pro twill logos are combined with sublimated stripes the result is a smooth professional finished look with a more lightweight feel.

Fabric Options

- Air Knit Pro Max (235 g/m²)
- Air Knit Pro (220 g/m²)
- Poly-Pro Mesh (260 g/m²)







DELUXE PENTAGON NECK WITH LACES

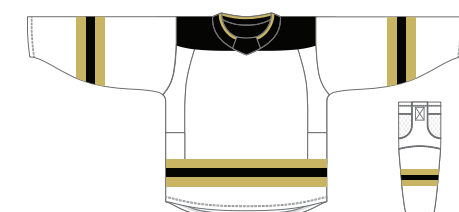
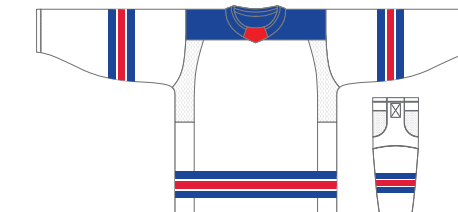

		
Jersey #2638 ★ Socks #729	Jersey #2681 ★ Socks #861	Jersey #2715 Socks #1089

PENTAGON NECK

		
Jersey #2609 ★ Socks #1027	Jersey #2829 ★ Socks #852	Jersey #2189 ★ Socks #1027

		
Jersey #2298 Socks #1803	Jersey #2214 ★ Socks #1027	Jersey #2477 ★ Socks #1101

		
Jersey #2479 Socks #1089	Jersey #2480 ★ Socks #242	Jersey #2515 ★ Socks #2516

	
Jersey #1974 ★ Socks #1027	Jersey #2597 ★ Socks #919

- ★ Deluxe Sock p. 46
- ★ Tempo Recommended
- ★ Revolutionary Hybrid Recommended

All styles are available in cut and sew or sublimation.

PENTAGON NECK



Jersey #2649 ★ Socks #920



Jersey #2710 ★ Socks #235



Jersey #2711 ★ Socks #235



Jersey #2768 ★ Socks #1089



Jersey #2640 ★ Socks #2641



Jersey #2189 Socks #1027

SQUARE V-NECK

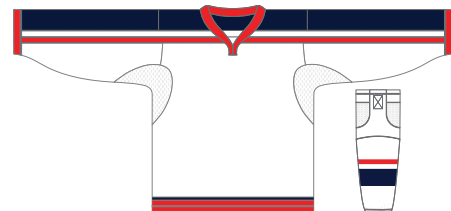

Jersey #2473 Socks #2474



Jersey #2610 ★ Socks #235



Jersey #2325 Socks #233

ROUND NECK



Jersey #2084 ★ Socks #2131



Jersey #1038 Socks #810



Jersey #2606 Socks #1089

ROUND W/ LACES



Jersey #1038 Socks #810

RECTANGLE NECK



Jersey #2606 Socks #1089

V-NECK



Jersey #1407 Socks #1089



Jersey #2248 ★ Socks #2193



Jersey #2232 ★ Socks #2127



Jersey #2268 ★ Socks #2171



Jersey #2310 ★ Socks #233



Jersey #2329 Socks #1089

TRIANGLE V-NECK



Jersey #387 ★ Socks #233

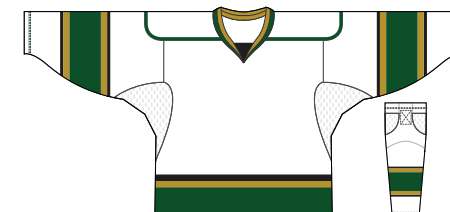

Jersey #729 ★ Socks #807



Jersey #2331 ★ Socks #2332

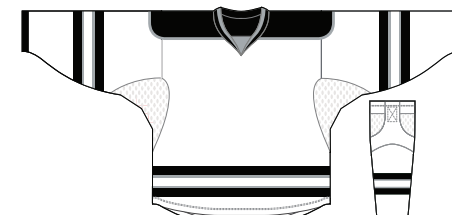

Jersey #1888 ★ Socks #1110



Jersey #2175 ★ Socks #242

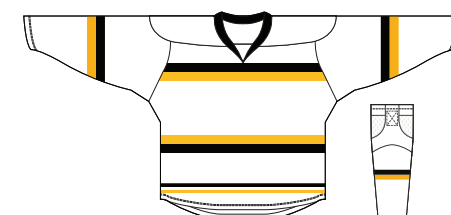

Jersey #2188 ★ Socks #373

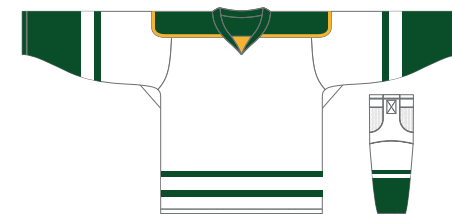

Jersey #2368 Socks #2222

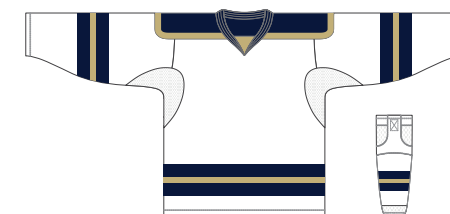

Jersey #2622 ★ Socks #961



Jersey #2737 ★ Socks #042



Jersey #2440 ★ Socks #1746



Jersey #2531 ★ Socks #1089



Jersey #2633 ★ Socks #1089



Jersey #2568 ★ Socks #005



Jersey #2621 ★ Socks #235



Jersey #1769 Socks #1082



Jersey #2651 ★ Socks #1027

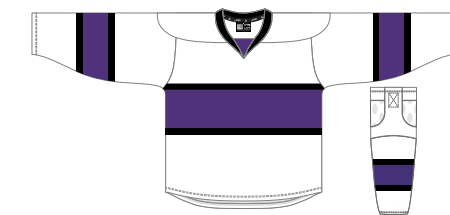

Jersey #2039 ★ Socks #861



Jersey #2216 ★ Socks #231

★ Deluxe Sock p. 46
 ★ Tempo Recommended
 ★ Revolutionary Hybrid Recommended

All styles are available in cut and sew or sublimation.

LACE NECK

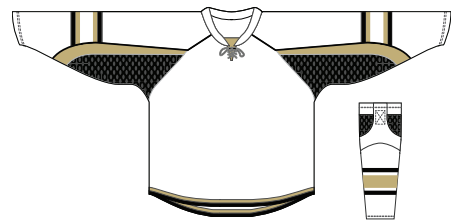

Jersey #89 ★ Socks #231



Jersey #197 ★ Socks #376

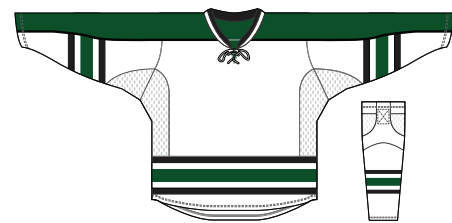

Jersey #766 ★ Socks #235



Jersey #2165 ★ Socks #1029

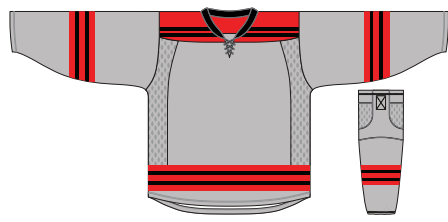

Jersey #1665 ★ Socks #1085



Jersey #1768 ★ Socks #233



Jersey #1775 ★ Socks #921

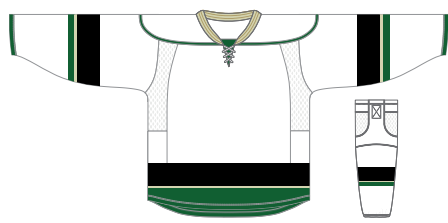

Jersey #1802 ★ Socks #1803

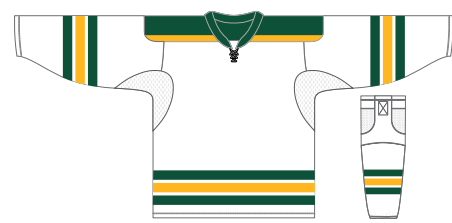

Jersey #1917 ★ Socks #1095



Jersey #2174 Socks #1895



Jersey #2259 ★ Socks #2260



Jersey #1979 ★ Socks #796



Jersey #1987 ★ Socks #1089



Jersey #2052 ★ Socks #2117

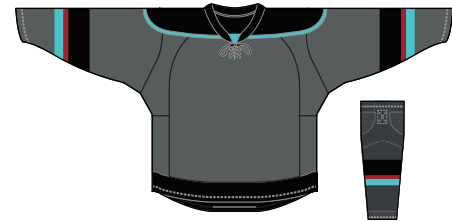

Jersey #2159 ★ Socks #2219



Jersey #2114 ★ Socks #2115



Jersey #2244 ★ Socks #2245

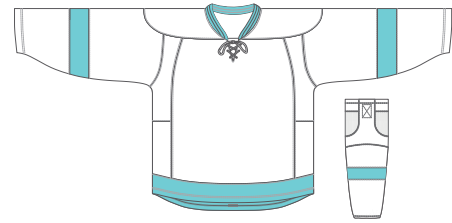

Jersey #2318 Socks #1089

LACE NECK



Jersey #2170 Socks #2171



Jersey #2192 ★ Socks #2193

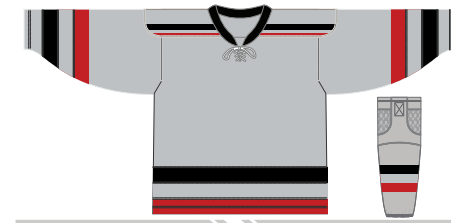

Jersey #2313 ★ Socks #242



Jersey #2342 ★ Socks #1089



Jersey #2417 ★ Socks #1089

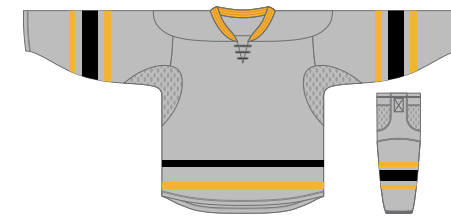

Jersey #2429 Socks #1706



Jersey #303 ★ Socks #959



Jersey #2594 Socks #2270



Jersey #2762 ★ Socks #1089

"Year after year, JOG provides us with outstanding quality, price and customer support."

- President Little Caesars Farmington Hills Hockey Association



★ Deluxe Sock p. 46
 ★ Tempo Recommended
 ★ Revolutionary Hybrid Recommended

All styles are available in cut and sew or sublimation.

DELUXE PENTAGON NECK WITH LACES

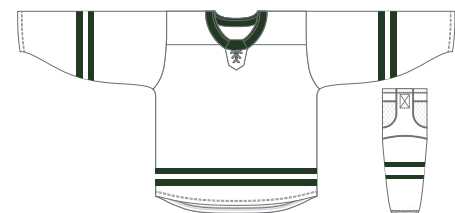

Jersey #2605 Socks #235

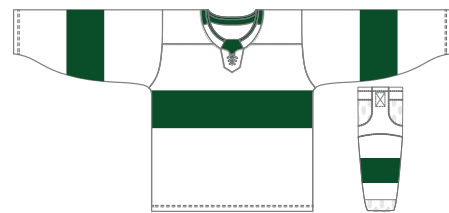

Jersey #2631 Socks #861



Jersey #2686 Socks #250

PENTAGON NECK



Jersey #2504 Socks #1089

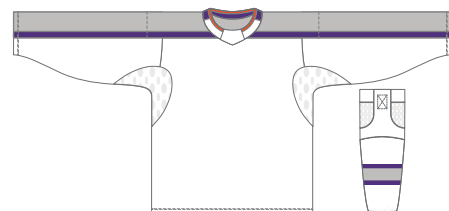

Jersey #2618 Socks #1089



Jersey #2280 Socks #2283

V - NECK

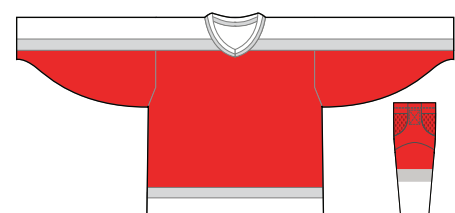

Jersey #1695 Socks #255

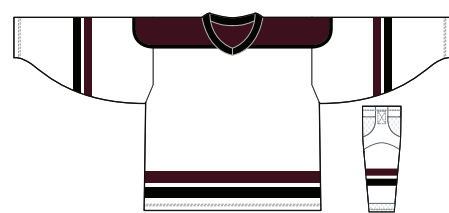

Jersey #2036 Socks #1699



Jersey #2302 Socks #2127

TRIANGLE V - NECK



Jersey #2330 Socks #2127



Jersey #2204 Socks #015



Jersey #2394 Socks #2393



Jersey #2592 Socks #1029



Jersey #2057 Socks #2058



Jersey #2632 Socks #1699

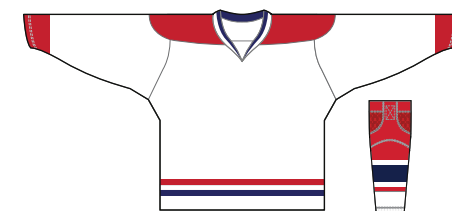

Jersey #2141 Socks #2151

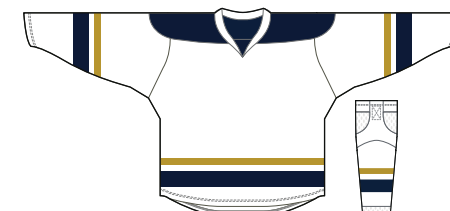

Jersey #2146 Socks #838



Jersey #2689 Socks #1042

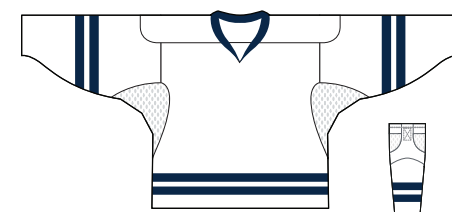

Jersey #2049 Socks #2050



Jersey #2185 Socks #005



Jersey #2126 Socks #2127



Jersey #2211 Socks #1089



Jersey #2300 Socks #1535



Jersey #2157 Socks #2158

LACE NECK



Jersey #2106 Socks #242



Jersey #1983 Socks #1089

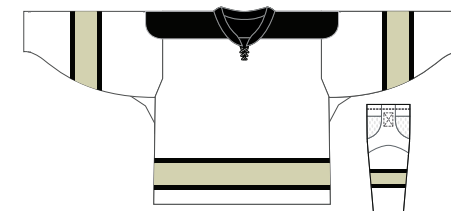

Jersey #2086 Socks #1089

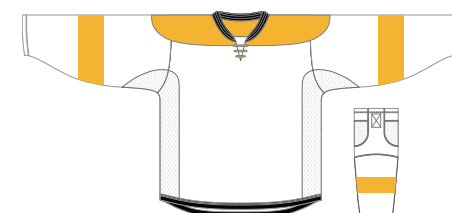

Jersey #2354 Socks #810



Jersey #2349 Socks #1089



Jersey #2353 Socks #005

★ Deluxe Sock p. 46
 ★ Tempo Recommended
 ★ Revolutionary Hybrid Recommended

All styles are available in cut and sew or sublimation.

DELUXE PENTAGON NECK WITH LACES



Jersey #2414 ★ Socks #2220



Jersey #2535 ★ Socks #959



Jersey #2542 Socks #1027



Jersey #2543 Socks #1027



Jersey #2549 ★ Socks #1089



Jersey #2593 ★ Socks #861



Jersey #2636 ★ Socks #1089



Jersey #2659 Socks #235



Jersey #2707 Socks #005

PENTAGON NECK



Jersey #2375 Socks #814



Jersey #2400 Socks #2719



Jersey #2434 Socks #1089



Jersey #2764 ★ Socks #2218



Jersey #2517 Socks #796



Jersey #2541 Socks #810



Jersey #2601 Socks #810



Jersey #2619 ★ Socks #1095



Jersey #2629 Socks #1089



Jersey #2539 Socks #2573



Jersey #2473 Socks #2474



Jersey #2581 Socks #959

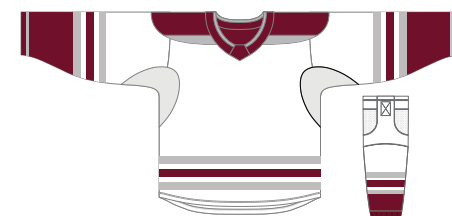

Jersey #2630 Socks #242

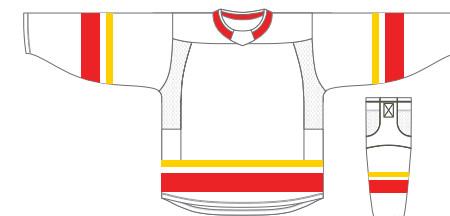

Jersey #2642 ★ Socks #959



Jersey #2668 Socks #1089



Jersey #2669 Socks #233



Jersey #2704 Socks #1104



Jersey #2705 Socks #1029



Jersey #2706 Socks #1029



Jersey #2678 Socks #1765



Jersey #2778 Socks #2719



Jersey #2779 Socks #921



Jersey #2784 Socks #005



Jersey #2969 Socks #810

★ Deluxe Sock p. 46
 ★ Deluxe Tempo Style
 ★ Revolutionary Hybrid Recommended

All Styles are available in cut and sew or sublimation.

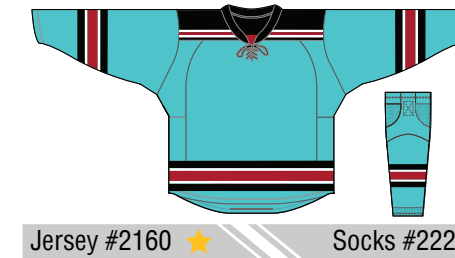
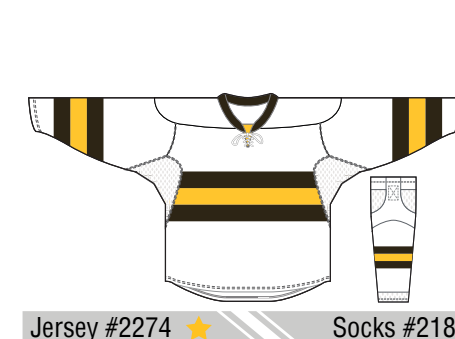
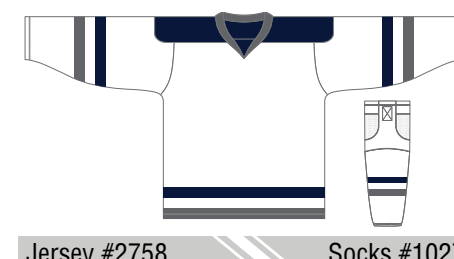
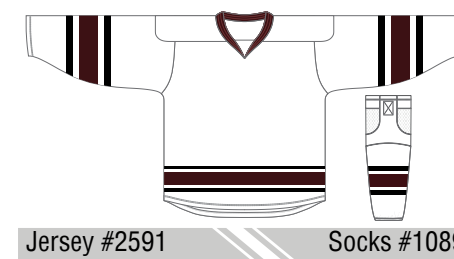
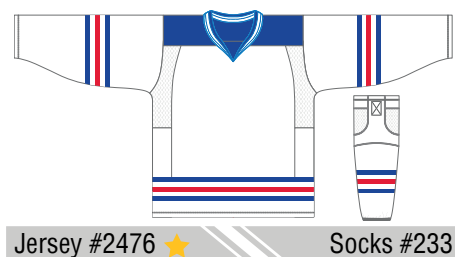
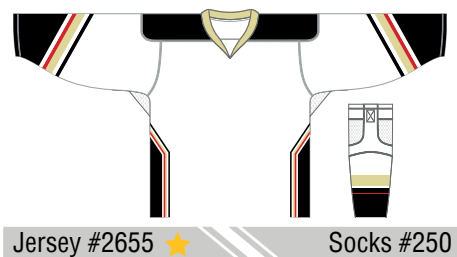
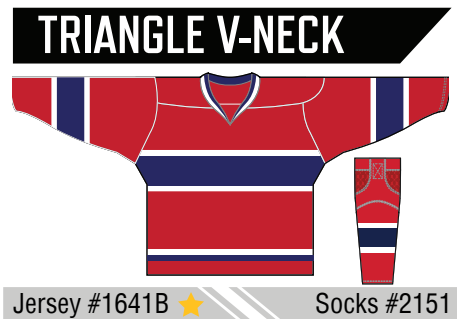
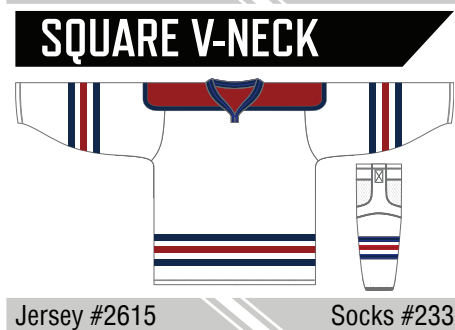
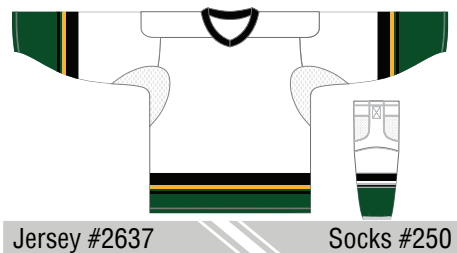

All styles are available in cut and sew or sublimation.

- ★ Deluxe Sock
- ★ Deluxe Tempo Style
- ★ Revolutionary Hybrid Recommended

LACE NECK



Jersey #2309 Socks #1535



Jersey #2328 ★ Socks #2441



Jersey #2334 ★ Socks #1568



Jersey #2339 Socks #2270



Jersey #2345 ★ Socks #2346



Jersey #2382 Socks #810



Jersey #2383 Socks #242

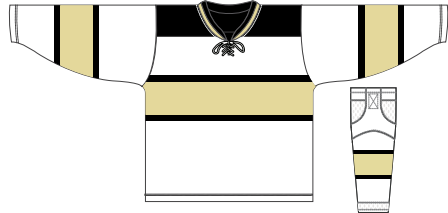

Jersey #2391 Socks #961



Jersey #2401 Socks #2402



Jersey #2419 ★ Socks #2452



Jersey #2421 Socks #233



Jersey #2427 Socks #233



Jersey #2432 Socks #235



Jersey #2455 Socks #1089



Jersey #2485 Socks #2486



Jersey #2493 ★ Socks #235



Jersey #2500 Socks #810



Jersey #2511 Socks #1699

LACE NECK



Jersey #2512 Socks #1089



Jersey #2547 ★ Socks #2254



Jersey #2583 ★ Socks #961



Jersey #2586 Socks #250



Jersey #2607 Socks #921



Jersey #2646 Socks #2713



Jersey #2648 Socks #921



Jersey #2650 Socks #1028

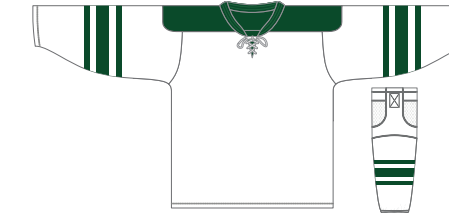

Jersey #2657 Socks #1029



Jersey #2665 Socks #1027



Jersey #2692 ★ Socks #2693



Jersey #2719 ★ Socks #1719



Jersey #2714 Socks #1029



Jersey #2730 ★ Socks #2193



Jersey #2760 Socks #2761

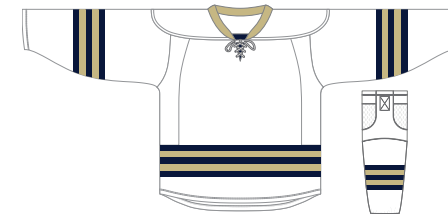

Jersey #2755 Socks #233

All styles are available in cut and sew or sublimation.

- ★ Deluxe Sock
- ★ Deluxe Tempo Style
- ★ Revolutionary Hybrid Recommended

Classic Cut & Sew or Sublimated Jersey



Style #1064

Fully Sublimated Jersey



Style #1225



Custom Neck Collar Options



Pro Tackle Twill Appliques



Cut and Sew Stripes

JOG is a fully licensed manufacturer of collegiate jerseys and apparel.



Custom Neck Collar Options



Unlimited Logos - Numbers - Colors - Fonts



Unlimited Styles and Graphics

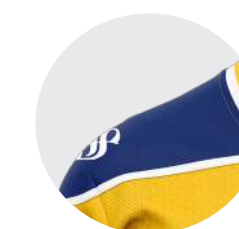

Double Material Support Elbows and Shoulders

JOG's Replica hockey jerseys are an excellent choice to round out your collection of fan apparel. Hockey jerseys are growing in popularity as spiritwear at many school sporting events, and can be a great fundraising opportunity! Note: JOG can provide a specific replica sizing chart designed for a relaxed, casual wear fit upon request.

Fabric Options

- Air Knit Pro Max (235 g/m²)
- Air Knit Pro (220 g/m²)
- Air Knit Pro X (205 g/m²)
- VaporICE Laser (220g/m²)
- Dura Light Plus (160g/m²)



Our fully sublimated Innovator jersey is a great value-priced option with excellent durability. Sublimation is the option of choice when there are complex designs, multiple sponsor logos or if a specific branded Pantone color is required. This option is growing in popularity due to its comfortable lightweight feel.

Fabric Options

- Air Knit Pro Max (235 g/m²)
- Air Knit Pro (220 g/m²)
- Air Knit Pro X (205 g/m²)
- Dura Light Plus (160 g/m²)



PENTAGON NECK WITH LACES



Jersey #2172 Socks #2472



Jersey #2470 Socks #2472



Jersey #2552 Socks #2474

PENTAGON NECK



Jersey #2481-A Socks #1029



Jersey #2495-A Socks #235



Jersey #2495-B Socks #111



Jersey #2190 Socks #005



Jersey #2553 Socks #250



Jersey #2384-A Socks #852



Jersey #2481-B Socks #861



Jersey #2389 Socks #005



Jersey #2495 Socks #852



Jersey #2223 Socks #852



Jersey #2384-B Socks #1089



Jersey #1419 Socks #793



Jersey #2384-C Socks #2416



Jersey #2787 Socks #852



Jersey #2503 Socks #852

LACE NECK



Jersey #2069 Socks #852



Jersey #1623 Socks #1089



Jersey #1950-B ★ Socks #1640

ROUND NECK



Jersey #943-A Socks #852



Jersey #943-B Socks #852



Jersey #2654 Socks #852

SQUARE V-NECK



Jersey #602 Socks #852



Jersey #1727 Socks #852

V-NECK



Jersey #2240 Socks #861

RECTANGLE NECK



Jersey #700 Socks #852



Jersey #2426 Socks #852



Jersey #2365 Socks #235

CROSS NECK

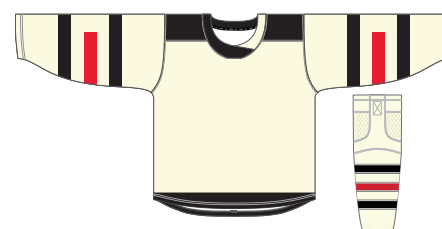

Jersey #2034 Socks #2035



Jersey #2033-B Socks #069



Jersey #1882-B Socks #005

Single Needle Stitch

Collar Support Binding

Double Material Support

Unlimited Colors for Names and Numbers

Custom Neck / Collar Options

Unlimited Colors and Logos

Double Material Support

Unlimited Styles and Graphics

Style #1419B

CANCER AWARENESS

<p>BELIEVE</p> <p>Jersey #1419B Socks #810</p>	<p>FAITH</p> <p>Jersey #1419B Socks #852</p>	<p>HOPE</p> <p>Jersey #1419B Socks #1089</p>
<p>STRONG</p> <p>Jersey #1419 Socks #852</p>	<p>STRENGTH</p> <p>Jersey #1225 Socks #852</p>	<p>SPIRIT</p> <p>Jersey #1959 Socks #1089</p>
<p>BRAVE</p> <p>Jersey #1419 Socks #852</p>	<p>COURAGEOUS</p> <p>Jersey #019B Socks #852</p>	<p>DETERMINATION</p> <p>Jersey #2240 Socks #852</p>

UGLY SWEATER / HOLIDAY

<p>SNOWBALL</p> <p>Jersey #1419B Socks #852</p>	<p>CAROLERS</p> <p>Jersey #1472 Socks #852</p>	<p>RUDDOLPH</p> <p>Jersey #2397 Socks #852</p>
<p>SAINT NICK</p> <p>Jersey #1959 Socks #852</p>	<p>BUDDY</p> <p>Jersey #50 Socks #852</p>	<p>XMAS</p> <p>Jersey #2240 Socks #852</p>

Custom Neck Collar Options	Unlimited Logos - Numbers - Colors - Fonts	Unlimited Styles and Graphics	Double Material Support Elbows and Shoulders

JOG can produce specialty uniforms for your occasions or to raise awareness for a cause important to your team. While sublimation is our most popular method of producing special occasion jerseys our design team can help create a customized specialty look for you in a range of styles.

Fabric Options

- Air Knit Pro Max (235 g/m²)
- Air Knit Pro (220 g/m²)
- Air Knit Pro X (205 g/m²)
- Dura Light Plus (160g/m²)



MILITARY / CAMO

HONOR

Jersey #232 Socks #852

OLD GLORY

Jersey #1623 Socks #852

SORTIE

Jersey #1651 Socks #852

UNITED

Jersey #1651 Socks #852

LIBERTY

Jersey #1798 Socks #852

VALOR

Jersey #2028 Socks #852

WARRIOR

Jersey #2033 Socks #852

PATRIOT

Jersey #2240 Socks #852

SOLDIER

Jersey #2384 A Socks #852

FIRST RESPONDER

PROTECT

Jersey #175 Socks #852

JUSTICE

Jersey #175 Socks #852

SERVE

Jersey #175 Socks #852

DUTY

Jersey #1419B Socks #852

SACRIFICE

Jersey #1419B Socks #852

HERO

Jersey #2022 Socks #852

SPACE WARS

ORION

Jersey #1217 Socks #852

GALAXY

Jersey #1217 Socks #852

REBEL

Jersey #1225 Socks #852

TROOPER

Jersey #2022 Socks #852

FORCE

Jersey #2022 Socks #852

VADER

Jersey #2022 Socks #852

AUTISM

ACCEPT

Jersey #019-A Socks #852

EMPOWER

Jersey #1225 Socks #005

ENCOURAGE

Jersey #019-B Socks #852

INSPIRE

Jersey #2022 Socks #852

BELIEF

Jersey #2288 Socks #852

ST. PATRICK'S DAY

BLARNEY

Jersey #1217 Socks #852

SHAMROCK

Jersey #2023 Socks #852

CELTIC

Jersey #2202 Socks #852

Fully Sublimated Reversible Game Jersey

Single Needle Stitch

V-Neck or Pentagon Collar

Unlimited Colors and Logos



Style #1564



Reversible Jersey



V-Neck or Pentagon Collar Option



Unlimited Logo - Number - Colors - Fonts



Unlimited Styles and Graphics

Fabric Options

Dura Light Plus (160 g/m²)



Cut & Sew or Fully Sublimated Practice Jersey

Outside Stitching

V-Neck Collar

Screen Printed Back Numbers



Screen Printed Logo or Sublimated Patch

Style #1031 Bazooka A



Team Logo on Both Sides



V-Neck Collar



Back Numbers on Both Sides

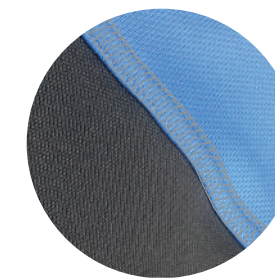

Outside Stitching

Looking for reversible practice jerseys at a great value? Look no further! We offer several unique designs that combine both one and two layer construction for a durable but lightweight feel.

Fabric Options

Air Knit Pro (220 g/m²)
 Dura Light (152 g/m²)
 Poly Pro Mesh (260 g/m²)



ECO-PRIMO STYLES

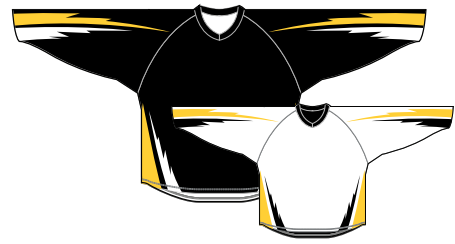

Jersey #1564-B



Jersey #2063-A



Jersey #2063-B



Jersey #2063-C



Jersey #2063-D

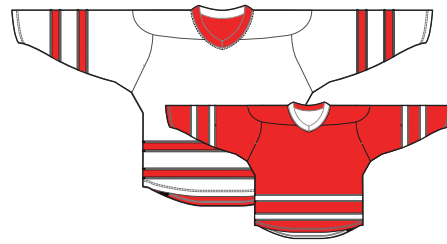

Jersey #2063-E



Jersey #2063-F



Jersey #1440-C



Jersey #2323-A ★

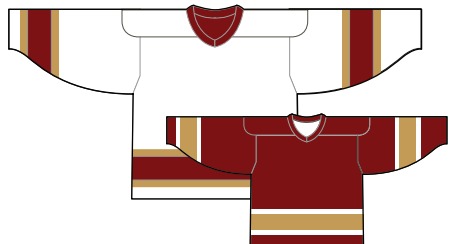

Jersey #1440-D



Jersey #2406-A ★



Jersey #2063

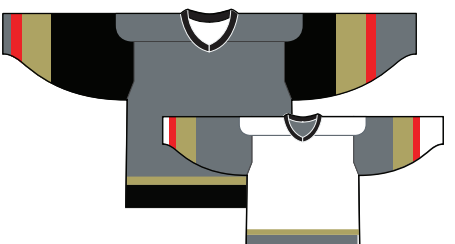

Jersey #1440-E



Jersey #1440-F

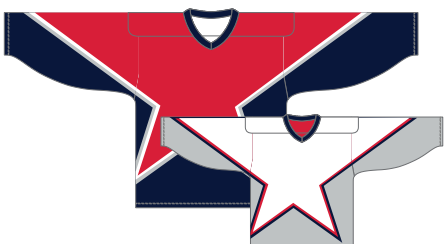

Jersey #1440-G

ECO-PRIMO STYLES



Jersey #2203



Jersey #07-A



Jersey #07-B



Jersey #07-C



Jersey #039-A

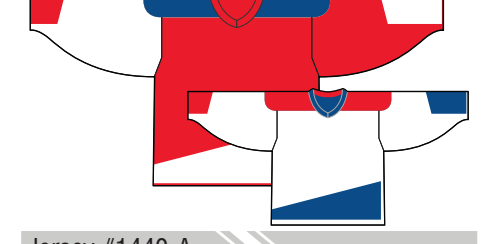

Jersey #1440-A



Jersey #2063-A



Jersey #2063-B



Jersey #2063-C

TRAINING STYLES

JET

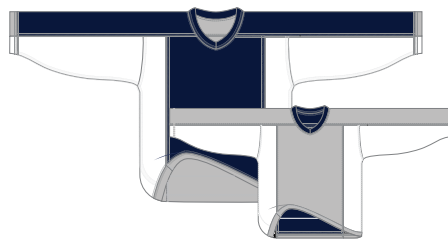

Jersey #491

ROBUST

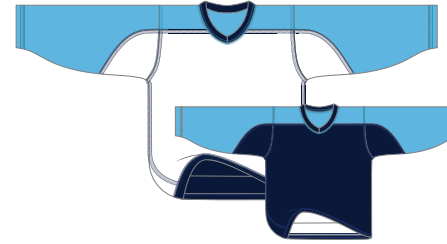

Jersey #118

BAZOOKA - A

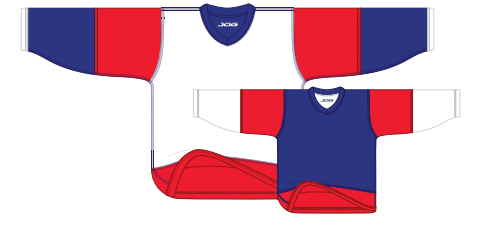

Jersey #1031

BAZOOKA - B

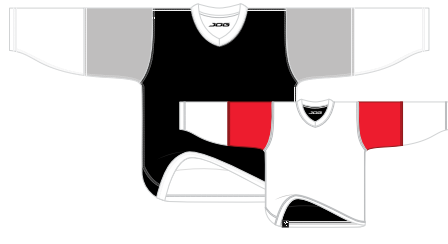

Jersey #2102

CLASSIC



Jersey #2514

★ Deluxe Collar

CLASSIC TRAINING JERSEY



Style #50

TWO-TONE POWER HOCKEY



Style #365

POWER HOCKEY REX



Style #073

VELOCITY TRAINING JERSEY



Style #1513

Fabric Options

- AK Pro Max (235 g/m²)
- Air Knit Pro (220 g/m²)
- Air Knit Pro X (205 g/m²)
- Dura Light (152 g/m²)
- Dura Light Plus (160 g/m²)

Features

- V-Neck, V-Rex, Square collar options
- Collar support binding
- Cover seam stitch
- Fully sublimated or Cut and Sew
- Pro Block Screen Print Numbers
- Optional mesh side panels
- Optional front patch logo

CLASSIC

CLASSIC

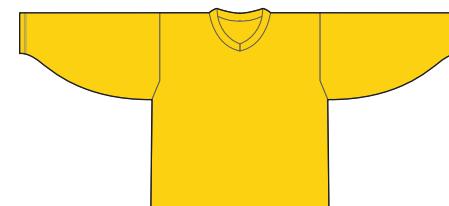

Jersey #50

CLASSIC TWO-TONE



Jersey #2022

CLASSIC ONE-TONE

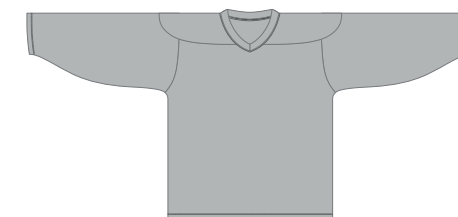

Jersey #2380

STANDARD

AERIAL



Jersey #232

FLYER



Jersey #1829

LANCER



Jersey #1830

POWER HOCKEY REX



Jersey #073

POWER HOCKEY TRIANGLE V-NECK



Jersey #175

TWO-TONE POWER HOCKEY



Jersey #365

TURBO

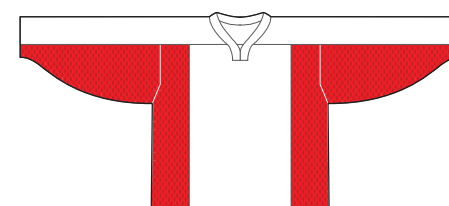

Jersey #831

FALCON



Jersey #1865

CLASSIC REX



Jersey #2426

DELUXE

Sublimation Recommended

SPARROW



Jersey #2317

EAGLE



Jersey #944

VELOCITY



Jersey #1513

Buckle Waist Closure

Front / Back Thigh Stretch Zone (Optional)

Front / Back Thigh Stretch Zone (Optional)



Logo Style #1921

Features

- Exterior - Abrasion resistant 840D nylon
- Stretch zones - (crotch, inseam, front/back thigh) 95% Polyester, 5% Spandex
- Durable, easy to use ladder lock buckle
- Optional side striping
- Optional logos and numbers
- Sublimation shell pants are available (any color or design).



#2320 #1869 #1421 #1563 #1618

Size Chart

HOW TO MEASURE:

1. It's best to measure and compare against an actual pair of shell pants and choose a corresponding size from our size chart (or size up / down as required).

2. If you don't have shell pants, you can measure against your hockey pants.

Note, the side length is the most important measurement. Measure your hockey pants from the waistline down to the bottom of the pants (not including the lower back / stomach protection area above the waist), then choose a corresponding size.

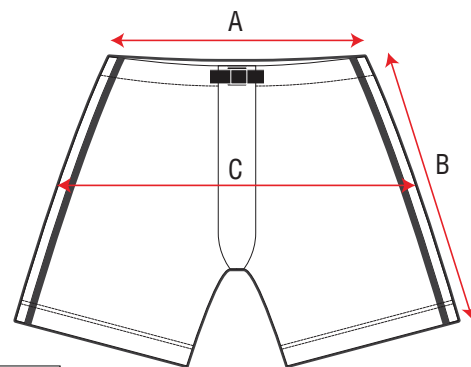

SHELL PANTS - YOUTH		YXS	YS	YM	YL	YXL	GC-YS	GC-YM	GC-YL
A	Waist Relax (inches)	15	16	17	18	19	18.5	19.5	20.5
B	Length (inches)	17	18	19	20	20.5	16	17	18
C	Hip (inches)	19	20	21	22	23	22.5	23.5	24

SHELL PANTS - ADULT		AS	AM	AL	AXL	A2XL	GC-AS	GC-AM	GC-AL	GC-AXL	GC-A2XL	GC-A3XL
A	Waist Relax (inches)	20	21	22	23	24	21.5	22.5	23.5	24.5	25.5	26.5
B	Length (inches)	21	22	23	24	24.5	19	20	21	21.5	22.5	23.5
C	Hip (inches)	24	25	26	27	28	25.5	26.5	27.5	28.5	29.5	30.5

TUFF PRO DELUXE



#1899



#2255



#2236



#2828

TUFF PRO PLUS



#2340



#2439
SUBLIMATED SIDE
PANELS



#1833



#1976

TUFF PRO



#43



#50



#2147



#2094

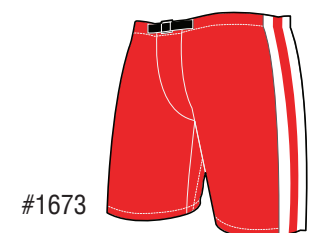

#1673



#1563



#1819



#1591



#2316



#1618
SUBLIMATED SIDE
PANELS



#1998



#2006

SUBLIMATED



#1421-A



#1421-C



#1561

Ultra Flex Hockey Bags



Reinforced Straps



Name card pocket

Screen number on mesh vents
(both sides of bag)

Features

- Strong and durable material
- Water Repellent
- Heavy weight webbing reinforced at carrying points

Size

- Junior 30" x 16" x 16"
- Senior 34" x 18" x 18"
- Goalie 40" x 20" x 20"
- Coach 22" x 12" x 12"

Fabric Content

Smooth Polyvinyl

Team Logo on both sides

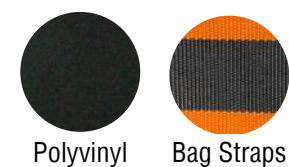

Travel / Coaches Bags



Name card pocket

Main Zipper

Pockets W: 6.25" x H: 6.25"

Team Logo one side

Garment Bags



Team Logo

Mesh

Two Zip Pockets

Small Hole for Hanger

Features

- Strong and durable material
- Mesh for ventilation
- Water Repellent

Size

27" x 46"

Fabric Content

Smooth Polyvinyl

Bag Straps

• White / Black / White



• White / Navy / White



• Black / Varsity Gold / Black



• White / Varsity Royal / White

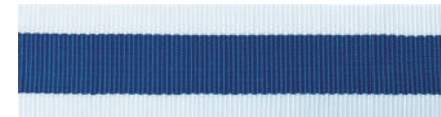

• White / Columbia Blue / White

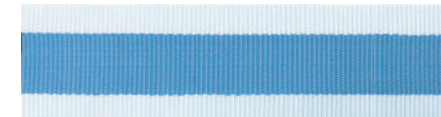

• White / Kings Purple / White



• White / University Red / White



• White / Dark Green / White



• White / Maroon / White



• White / Kelly Green / White



• White / Mission Green / White

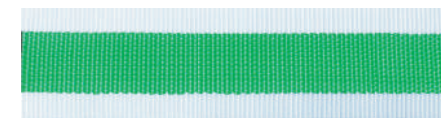

• Black / Tennessee Orange / Black



• White / White / White



• Black / Black / Black



For custom bag strap options please ask your sales representative for availability.

Sports / Coaches Bags

Polyvinyl

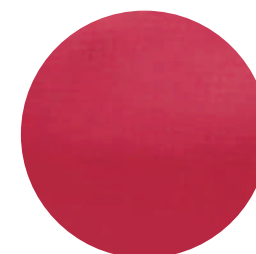

University Red

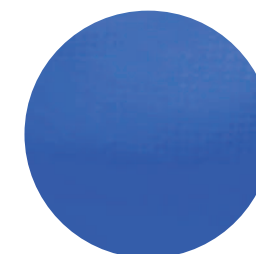

Varsity Royal

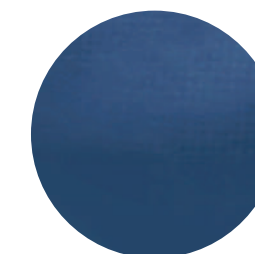

Navy

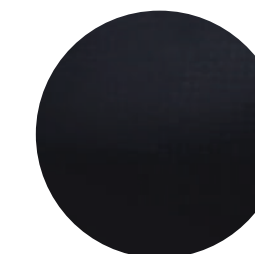

Black

Garment Bags

Polyester



Black



STANDARD SOCK
SIMPLE STRIPING OR
SUBLIMATION UNDER 5 INCHES



DELUXE SOCK
ADVANCED STRIPING OR
SUBLIMATION OVER 5 INCHES



SUBLIMATION SOCK
CUSTOM COLOR OR
DESIGN



TRAINING SOCK
CUT AND SEW
NO MESH INSERT

Features

- Pro game weight (Poly-Pro PK)
- Velcro inserts stitched into the sock for easy attachment to jock shorts
- Mesh inserts near the thigh for breathability
- Relaxed fit, comfortable and durable
- Cut and sew, sublimated or hybrid socks
- Optional double material in the knee
- Optional single or double-needle stitching



Cut and sew is the more traditional and professional style.

If sublimation striping exceeds 7" the entire sock will need to be sublimated



Sublimated striping allows for more customization.

Fabric Options

- Dura Light (152g/m²)
- Air Knit Pro (220g/m²)
- Endurance Pro PK (270g/m²)
- Poly-Pro Mesh (260g/m²)
- Stretch Pro Mesh (280g/m²)
- Dura Light Plus (160 g/m²)

Size Chart

HOCKEY SOCK - JUNIOR		YXS	YS	YM	YL
A	Length (inches)	18	20	22	24
B	Top Opening (inches)	17.25	17.5	18.75	19.75

HOCKEY SOCK - SENIOR		AS	AM	AL	AXL	A2XL
A	Length (inches)	26	28	30	32	34
B	Top Opening (inches)	21	21.75	22.75	24	25.25

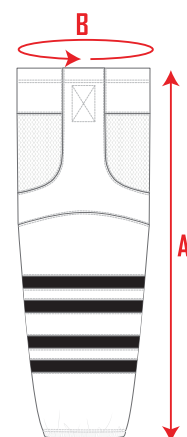

MEN

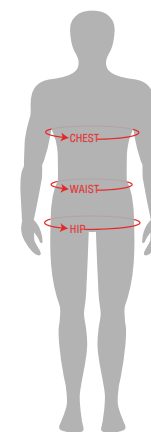

SIZE	CHEST	WAIST	HIP
AS	34.5 - 37	29-31	35.5 - 37.5
AM	37.5 - 40	31.5 - 33.5	38 - 40
AL	40.5 - 43.5	34 - 37.5	41 - 43
AXL	44 - 47.5	38 - 42	44 - 46
A2XL	48 - 52	43 - 47	47 - 50
A3XL	53 - 56	48 - 52	51 - 54

WOMEN

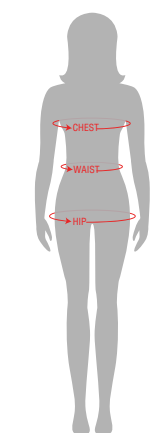

SIZE	CHEST	WAIST	HIP
AXS	31.5 - 33.5	24 - 26	34 - 36
AS	33.5 - 35.5	26.5 - 28.5	36.5 - 38.5
AM	33.5 - 38.5	29 - 31	39 - 41
AL	38.5 - 41.5	31.5 - 33.5	41.5 - 43.5
AXL	41.5 - 44.5	34.5 - 36.5	44.5 - 46.5
A2XL	44.5 - 47	37 - 40	47 - 50

BOYS

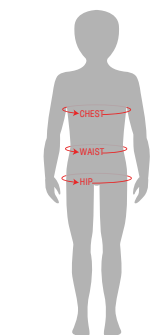

SIZE	CHEST	WAIST	HIP
CHILD	23 - 24	22 - 23	25 - 26
YXS	24.5 - 26	23 - 24	27 - 28
YS	26.5 - 28	24 - 25	28 - 29
YM	28.5 - 30	25 - 27	29.5 - 31
YL	30.5 - 32	27.5 - 28.5	31.5 - 33
YXL	32.5 - 34	28.5 - 30	33.5 - 35

GIRLS

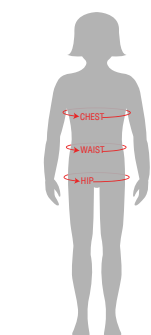

SIZE	CHEST	WAIST	HIP
YS	25.5 - 27	23 - 24	27.5 - 29.5
YM	27.5 - 29	24.5 - 26	30 - 32
YL	29.5 - 31	26.5 - 28	32.5 - 34

CHEST: Measure around the fullest part of the chest, keeping the measuring tape horizontal.
 WAIST: Measure around the smallest part of the torso area.
 HIP: Measure around the fullest part of the hip and ensure the tape is straight.

GRINDE

S E R I E S



GRINDE IT. SEW IT. WEAR IT.

Coffee is not just for drinking anymore. It's now part of our apparel. We repurpose coffee grounds and layer them into fabrics that wick away moisture and control odor. Grinde brings a whole new meaning to your morning cup of joe.



VaporICE Plus/Super Plus
Plus - 100% Recycled Polyester (160g/m²)
Super Plus - 100% Recycled Polyester (128g/m²)
Eco-Friendly, superior dry touch and cool comfortable fit
Application: T-Shirts, Shorts

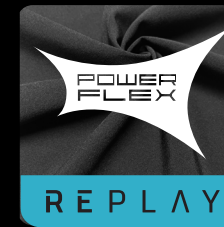

Power Flex Range
89% Recycled Polyester, 11% Spandex
4-way stretch and quick drying
Application: Shorts



VaporICE Drip
65% Polyester, 35% Recycled GRINDE Polyester soft durable PK Fabric (160g/m²)
Fast drying, odor control, UV-Protection
Eco-Friendly, flexible stretch and comfortable fit
Application: T-Shirts, Polos and Shorts



Power Flex Pique
94% Polyester, 6% Spandex pique (160g/m²)
Anti-bacterial and UV protection
Flexible stretch, comfortable and superior wicking
Application: Polos



VaporICE Everest
100% Micro Woven Polyester (110g/m²)
Dobby Weave
Durable, yet soft hand feel
Application: Tracksuits and Polos

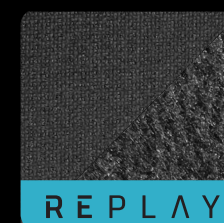

Thermal Form Replay
100% Recycled Polyester pique fleece (250g/m²)
Back side brushed, shields the cold and wind
Application: Jackets, Hoodies and Joggers



VaporICE T-Force Stretch
100% Recycled Polyester (155g/m²)
Permanent wicking yarn with mechanical stretch
Sheer looking fabric with honeycomb texture
Application: T-Shirts, Shorts, Polos

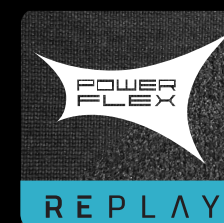

Power Flex Yield Thermal Form
89.3% Micro Recycled Polyester, 10.7% Spandex
Sanding face with brushed back fleece (295g/m²)
Application: Jackets and Joggers



Power Flex Elite
88% Polyester, 12% Spandex
Moisture management
Flexible stretch, comfortable and super wicking
Application: T-Shirts

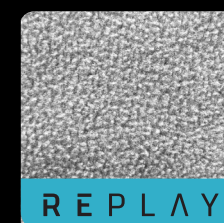

Polar Fleece
100% Recycled Polyester
Two side brush with anti-pilling
Soft and warm
Application: Jacket Lining



VaporICE Nitro
77% Polyester, 23% Recycled Polyester
Soft, moisture wicking, and odor control
Application: T-Shirts

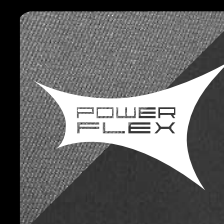

Everest Power Flex Drift
90% Nylon, 10% Spandex
Durable, water repellent, 4-way stretch and Anti-UV
Application: Tracksuits

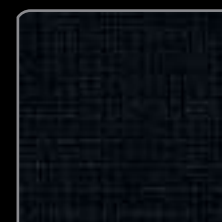

Everest Storm Soft Shell
86% Polyester, 14% Spandex (314 g/m²)
4-way stretch, back fleece, water repellent
Application: Soft Shell Jackets

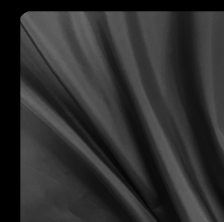

Everest Surge
100% Polyester
Water repellent with a polished, smooth finish that is lightweight yet durable
Application: Jackets

Performance Jackets

Style #1833 - Patriot

Full Zip or 1/4 Zip



Team Logo

Invisible Side Zip Pockets

Features

- A mid-weight, relaxed, comfortable 4-way stretch jacket
- Full zip or 1/4 zip options
- Invisible side zip pockets
- Team Logo: screen printed, embroidered or sublimated

Fabric Options

Power Flex Yield Thermal Form (Replay Series)

BLACK PMS 282C DARK NAVY WHITE (sublimated option)

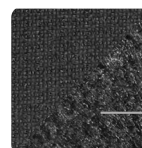

Soft Inner Lining



Storm Soft Shell Jackets

Style #2013 - Storm Classic

Full Zip or 1/4 Zip



Team Logo

Invisible Side Zip Pockets

Features

- 3-layer soft shell that protects against cold, wind and snow; keeping warmth in and moisture out
- Durable and water repellent
- Embroidery Logo
- Full zip
- The soft shell has a 4-way stretch that makes it comfortable during athletic activity

Fabric Options

Everest Storm Soft Shell

UNIVERSITY RED DARK NAVY BLACK

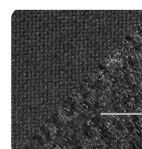

Soft Inner Lining

STANDARD PERFORMANCE JACKETS



#1883 - PATRIOT



#1936 - CLASSIC



#3071 - RAKER



#2773 - TOBO

The Performance Jacket is definitely one of my go-to jackets. It's light-weight and comfortable whether I'm on the ice, a bus, or just day to day. The Joggers are hands-down the best pants to wear on long bus trips!

-Alex Grose : Asst. Coach George Mason University Club Hockey



DELUXE PERFORMANCE JACKETS



#722B - WARRIOR



#722B - DUAL WARRIOR



#3020 - EQUINOX



#2509 - COLONIAL



#2931 - HARVEST



#722 - STRATUS

SOFT SHELL JACKETS



#3078 - STORM CLASSIC



#2013 - STORM PULSE

★ Tempo Hybrid Recommended
★ Tempo Hybrid Recommended

EVEREST SURGE STRETCH

Style #2060 - Classic Stretch



Features

- Insulated areas have a polished, smooth exterior finish
- Eco-thermal insulation shields you from the cold and repels water
- Non-insulated areas have 4-way stretch
- Full body zipper
- Invisible side pockets
- Optional sublimated team logo, names and numbers on 4-way stretch zones
- Team Logo: screen printed or embroidered on insulated areas

Fabric Options

Everest Surge - Base body

BLACK	Cool Grey 7C	PMS 282C DARK NAVY
PMS 200C UNIVERSITY RED	PMS 3308C FOREST GREEN	

Power Flex Yield - 4-way stretch

BLACK	PMS 282C DARK NAVY	WHITE
-------	--------------------	-------

(sublimated option)

Eco-Thermal Insulation

- 65% Recycled Polyester (Replay Series)
- 35% Recycled Polyester (GRINDE Series)



EVEREST SURGE

Style #2098 - Classic



Features

- Insulated areas have a polished, smooth exterior finish
- Eco-thermal insulation shields you from the cold and repels water
- Full body zipper
- Invisible side pockets
- Embroidered team logo
- Optional embroidered number
- Optional Polar Fleece inner lining
- Team Logo: screen printed or embroidered

Fabric Options

Everest Surge - Base body

BLACK	Cool Grey 7C	PMS 282C DARK NAVY
PMS 200C UNIVERSITY RED	PMS 3308C FOREST GREEN	

Polar Fleece - Inner lining (Optional)

BLACK	Cool Grey 7C	PMS 282C DARK NAVY
-------	--------------	--------------------

Eco-Thermal Insulation

- 65% Recycled Polyester (Replay Series)
- 35% Recycled Polyester (Grinde Series)

EVEREST SURGE STRETCH JACKETS

ALL STYLES ARE HYBRID



#2060 - CLASSIC STRETCH



#2078 - KWAWZA



#2487 - TOBO



#2487 - NOREASTER



#2879 - DUVET



#2694 - CLASSIC STRETCH W/ HOOD

EVEREST SURGE JACKETS



#2098 - CLASSIC



#2868 - CLASSIC SLEEVELESS

The surge jackets are a team favorite! They are perfect for our long road trips in the winter and all the hours we spend at rinks throughout the season!

— Drew Harper, Bowling Green State University Club Hockey Coach



PERFORMANCE TRACKSUITS

Tracksuit Style #2121 - Navigator

Polar Fleece Collar (Optional)

Piping

Embroidered Logo

Invisible Zipper Pockets

Comfort Fit Waistband

Embroidered Logo

99

Open Leg Zipper

Features

- Water repellent and 4-way stretch (Power Flex Drift only)
- Full body zipper and invisible side zip pockets
- Nylon and mesh inner lining
- Optional Polar fleece collar lining
- Optional cell phone pocket
- Optional adjustable velcro cuffs
- Elastic and draw cord waistband
- Bottom side zippers - optional drawcord or adjustable velcro leg opening
- Nylon inner lined cuff and bottom pants hem

Fabric Options

VaporICE Everest (Not water repellent)

BLACK	Cool Grey 7C	PMS 282C DARK NAVY
PMS 200C UNIVERSITY RED	PMS 3308C FOREST GREEN	WHITE

Power Flex Drift (Water repellent)

PMS 282C DARK NAVY	BLACK
--------------------	-------



JACKET #2082 - MONARCH
PANT #2060 - NAVIGATOR

STANDARD STYLES



JACKET #2231 - CLASSIC
PANT #837D - CLASSIC



JACKET #2121 - NAVIGATOR
PANT #727 - NAVIGATOR



JACKET #3072 - RAFALE
PANT #3073 - RAFALE

HYBRID STYLES



JACKET #2082 - MONARCH
PANT #727 - NAVIGATOR



JACKET #3074 - HURRICANE
PANT #3075 - HURRICANE



JACKET #2977 - TEMPEST
PANT #837D - CLASSIC

DELUXE STYLES



JACKET #2152 - DOBI
PANT #837D - CLASSIC



JACKET #836 - STEALTH
PANT #837 - STEALTH

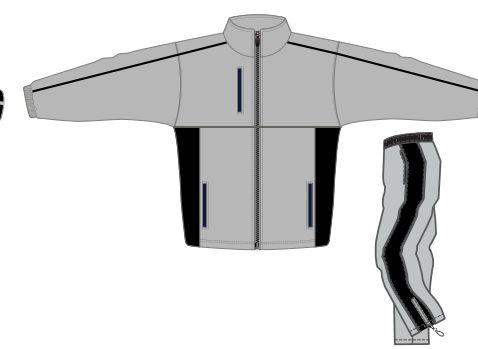

JACKET #836 - STEALTH TWO-TONE
PANT #2060 - NAVIGATOR

SEMI FIT PANT STYLES



#2574 - CLASSIC SEMI FIT



#2845 - STEALTH SEMI FIT



#2538 - NAVIGATOR SEMI FIT



#2519 - SPITFIRE SEMI FIT

PERFORMANCE HOODIES

Style #600 - Bobcat



Branded Hood Lining
(Sublimated Only)

Laces (Optional)

Team Logo

Features

- Thermal form shields you from the cold and wind with minimal weight and bulk
- Soft knit construction, comfortable stretch and smooth feel
- Elastic knit rib or rib cuff and hem
- Optional Kangaroo pocket
- Team logo and appliques: screen printed, embroidered or sublimated
- Optional Hockey laces
- Men, Women and Youth sizing

Fabric Options

Thermal Form (Replay Series)

PRO SILVER	DARK NAVY	BLACK	VARSIITY ROYAL
WHITE	FOREST GREEN	UNIVERSITY RED	



SUBLIMATED HOODIES

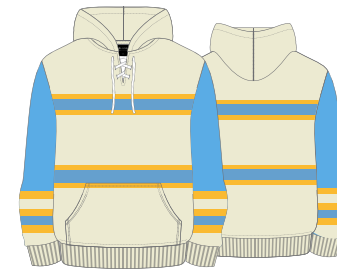

#600C - ST. LOUIS



#600C - WEBSTER



#600C - NORTHERN



#1543B - BUTLER



#600C - KNOXVILLE



#600 - SPYKER



#600C - VEGAS



#600 - WOLVES



#600C - BOBCAT



#600C - KNIGHTS



#1543B - HOPKINS

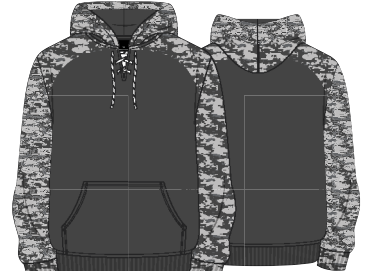

#600C - GOLDEN JACKAL



#600 - DRAGONS



#600C - VICTORY



#600 - BLAZERS



#600 - CITATION



#600B - KNIGHTS



#600 - GOLDEN JACKAL

HYBRID HOODIES

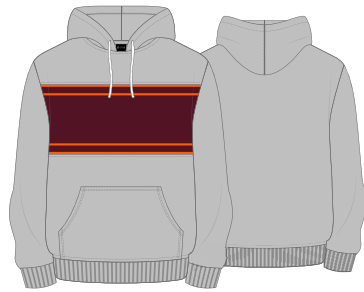

#2932 - LAWKIN



#2886 - CITATION



#600C - EVERGREEN



#600C - SABLE

Logos and numbers are placed in the sublimated portion of our hybrid hoodies. (See Citation on p. 56)

CUT & SEW STANDARD HOODIES



#600 - OUTLAW



#1543B - CLASSIC DUAL



#600 - CLASSIC



#600C - BRONCOS



DELUXE #2436 - MOUNTAINEERS



DELUXE #2488 - HORNET



DELUXE #2281 - STREAKER

PERFORMANCE JOGGERS

Style #1809 - Classic



#1809 - MUDI



#1809 - SPITZ



#1809 - GREYHOUND

Features

- Thermal form shields you from the cold and wind with minimal weight and bulk
- Soft knit construction, comfortable stretch and smooth feel
- Full elastic waistband with draw cord
- Invisible side pockets
- Elastic knit or rib bottom cuff
- Brushing back fleece
- Men, Women and Youth sizing

Fabric Options

Thermal Form (Replay Series)

PRO SILVER	DARK NAVY	BLACK	VARSLITY ROY
WHITE	FOREST GREEN	UNIVERSITY RED	

Power Flex Yield Thermal Form (Replay Series)

BLACK	PMS 282C DARK NAVY	WHITE
-------	--------------------	-------

(sublimated option)



SUBLIMATED JOGGERS



DELUXE STYLE #1673 - ZEBRA



#1809 - GREYHOUND



#1809 - SALUKI



#1809 - TERRIER



#1809 - AKITA



#1809 - MASTIFF

HYBRID JOGGERS



#1809 - MUDI



#1809 - SPITZ



#1809 - BORZOI

CUT & SEW JOGGERS



#1809 - CLASSIC



DELUXE STYLE #2489 - TERVUREN

PERFORMANCE POLOS

Style #301 - Horizon



Features

- Lightweight feel and superior performance
- Super wicking capabilities
- Elastic tape on the collar to add comfort and durability
- Custom embroidery or sublimation available
- Men, Women and Youth Sizing

Fabric Options

VaporICE T-Force Stretch (Replay Series)



Power Flex Pique



VaporICE Nitro (GRINDE Series)



VaporICE Plus (Replay Series)

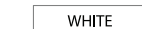

VaporICE Drip (GRINDE Series)



#301 - DETERMINE



#301 - ALCATRAZ



#301 - BARBARO

CUT AND SEW POLOS



#2206 - CLASSIC



#301LS - CLASSIC LS



#301 - TWIST



#301 - RENEGADE DUAL



#2206 - CLASSIC PREP

HYBRID POLOS



#301 - ARISTIDES



#1788 - ARION



#301 - BARBARO



#301 - COLLEGIATE



#301 - ORB

SUBLIMATION POLOS



#1788 - AFFIRMED



#301 - ALCATRAZ



#301 - CHOLLA



#301 - COMBAT



#301 - DONERAIL



#301 - GRIDIRON



#301 - HORIZON



#301 - MERIDIAN



#301 - DETERMINE



#301 - PHOENIX



#301 - SPARTAN



#301 - TYPHOON

PERFORMANCE SHORTS

Style #1040 - Camaro



Features

- Lightweight feel and superior performance
- Excellent wicking capabilities
- Full elastic waistband and drawcord
- Custom inseam available
- Optional inner lining and pockets
- Custom embroidery or sublimation available

Fabric Options

VaporICE Plus (Replay Series)

WHITE DARK NAVY

VaporICE Drip (GRINDE Series)

WHITE BLACK PRO SILVER DARK NAVY

VaporICE T-Force Stretch (Replay Series)

WHITE BLACK COLUMBIA BLUE DARK NAVY

VaporICE Nitro (GRINDE Series)

MELANGE BLACK

Power Flex Range

WHITE BLACK



#1715 - PACER



#1040 - FIERO

CUT AND SEW SHORTS

ALL STYLES CAN BE SUBLIMATED



#1040 - CLASSIC



#1645 - LINEAR



#602 - RACER



#1715 - PACER

HYBRID SHORTS



#1715 - CAMARO



#1040 - DAYTONA



#1040 - MUSTANG



#1040 - PANTHER



#1040 - SQUIRE

SUBLIMATION SHORTS



#1845 - CHEVELLE



#1040 - FERRARI



#1040 - FIERO



#1040 - PAGANI



#1715 - AFFIRMED

PERFORMANCE SHIRTS

Style #1035 - Sniper



Style #073 - Tornado



Features

- Lightweight feel and superior performance
- Excellent wicking capabilities
- Elastic tape on the collar to add comfort and durability
- Custom screen printing or sublimation options
- Men, Women, and Youth sizing available
- Rib cuffs optional for long sleeve shirts

Fabric Options

VaporICE Plus (Replay Series)



VaporICE Super Plus (Replay Series)



VaporICE Drip (GRINDE Series)



VaporICE T-Force Stretch (Replay Series)



Power Flex Elite



VaporICE Nitro (GRINDE Series)

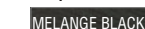

#201 - COLLEGIATE



#206 - STREAKER



#201 - CITATION

CUT AND SEW SHIRTS



#201 - CLASSIC



#073 - RENEGADE DUAL



#1514 - AVENGER



#811 - THUNDER



#1035 - CLASSIC L/S

HYBRID SHIRTS



#1035 - OUTLAW



#2026 - TONALIST



#201 - LAWKIN



#201 - HORIZON

SUBLIMATION SHIRTS



#201 - AFFIRMED



#201 - DONERAIL



#201 - ZENVO



#073 - TORNADO



#201 - FORBES



#073 - THUNDERBIRD



#519 - ORCA



#817 - DOMINATOR



#201 - DRIFTERS



#201 - SIENA



#1035 - MUSTANG



#1035 - PLAYMAKER



#1035 - WOLVERINE



#1035 - ZENVO L/S



#1035 - CRUISER L/S

Shadow X Performance Hats



Features

- Custom team hats - 100% Polyester
- Structured back with snapback
- Available in variety of colors
- Melange texture for all colors
- MOQ - 20 units

Available Colors

- BLACK DOLPHIN GRAY NAVY

Trucker Hat



Features

- Custom team hats - 100% Polyester
- Structured mesh back with snapback
- With embroidered logo + jacquard embroidery
- MOQ - 20 units

Available Colors

- BLACK NAVY

Northern Eco Hat



Features

- Custom team hats - 100% Recycled Polyester Twill
- Structured back with snapback
- With embroidered + jacquard embroidery
- MOQ - 20 units

Available Colors

- COOL GREY 8C

Pom Pom Beanies



Features

- Custom Pom Pom - 100% Acrylic
- With embroidered logo + jacquard embroidery
- MOQ - 100 units

Beanies



Features

- Custom beanies - 100% Acrylic
- With embroidered logo + jacquard embroidery
- MOQ - 20 units



YOUR LOOK. DONE RIGHT.

JOG

JOIN OUR GAME

North America

JOG ATHLETICS LLC
501 SILVERSIDE RD.
WILMINGTON, DE 19809
PHONE: (302)538-9444

Asia

JOG SPORTS CO, LTD
99 SOI PAYASURENT 35
BANGKOK, THAILAND 10510

WWW.JOGSPORTSWEAR.COM

 INFO@JOGSPORTS.COM

 JOG ATHLETICS

 JOGATHLETICS

 JOGATHLETICS