

2024



**ATHLETIC
EQUIPMENT
CATALOG**

MAKE WINNING POSSIBLE®

trigonsports.com



As a family-owned and operated business with over 60 years of combined experience in the sporting goods industry, Trigon Sports provides high-quality sports equipment for high school, collegiate, and professional programs. Our goal was not to change the sporting goods industry, but simply make it better. Even as our reputation for providing quality sports equipment grew, our reputation for great customer service grew faster.

Through our trademarked brand of sports equipment, ProCage™ and Practice Partner®, we have expanded our product line from baseball and softball, to football, lacrosse, soccer, and more. Our business model is simple: Focus on the customer, provide them with high quality sports equipment, and perhaps most important, love what we do. Here at TSI, we love what we do, and it shows from the moment you call us. We are proud to serve our loyal customers, and even more proud that we help them **“Make Winning Possible®”**.

We want to say thank you to all of our local team dealers, team catalog sales reps and loyal customers who use our products every day!

We appreciate you choosing Trigon Sports and we look forward to the opportunity to continue to build relationships with you in the years to come.

**It is our pleasure to serve around the globe and help
MAKE WINNING POSSIBLE.®**



2019
Local Champion



Official Field
Equipment Supplier



Official Field
Equipment Supplier

888-313-1303 • sales@trigonsports.com

CONTENTS

2 PRACTICE PARTNER

Our line of at-home practice equipment to ensure you Make Winning Possible.

4 BASEBALL/SOFTBALL

- 4 Rollaway Batting Cages
- 5 Indoor Electric Batting Cages
- 6 Poly Tunnel Nets & Frames
- 7 Cantilever Batting Cage Frames
- 8 Custom Netting
- 9 Protective Screens
- 13 Ball Caddies
- 14 Training Aids
- 16 Pitching Machines
- 17 Foul Poles
- 18 Halo Kits
- 19 Turf Mats
- 20 Custom Turf
- 21 Pitcher's Mounds
- 25 Pitching Rubbers
- 26 Base Sets
- 28 Field Dirt Products
- 28 Field Maintenance
- 31 Drag Mats
- 32 Dry Liner Markers/Templates

- 33 Field Marking
- 34 Irrigation
- 35 Field Covers & Protectors
- 39 Temporary Fencing
- 41 Fence Protectors
- 42 Fence Screens
- 43 Rail Padding
- 44 Stadium Padding
- 45 Facility Solutions/Indoor Padding

48 BASKETBALL

- 48 Scoreboards
- 49 Ball Carts
- 50 Rims
- 51 Backboards

52 TRAINING

- 52 Sports Speed & Agility

53 FOOTBALL

- 53 Training Aids
- 54 Equipment Storage
- 55 Gameday Field Layout/Equipment
- 56 Sideline Protectors
- 57 Goal Posts
- 58 Dummies/Pads

59 LACROSSE

- 59 Goals

62 SOCCER

- 62 Gameday Field Equipment
- 63 Goals

65 HOCKEY

- 65 Goals/Shooting Target

66 VOLLEYBALL

- 66 Net Systems/Nets
- 67 Rollaway Standards/Training Aids

68 BANNERS

- 68 Sports Banners/Flags
- 69 Bleacher Enclosures

70 BLEACHERS

- 70 Standard Aluminum
- 71 Low-Rise/Tip & Roll
- 72 Supreme Series/ADA Compliant
- 73 Team Benches



PRACTICE PARTNER.

FROM THE FIELD TO THE BACKYARD.

Practice Partner was founded in 1982 by Joseph Rajacich, a father of two little league ballplayers, who saw the need for a better way to practice at home. Under the leadership of Rajacich's sons, Alex and Andrew, the Practice Partner group of products expanded into a full line of team sports training aids.

Trigon Sports acquired the Practice Partner name and product line in 2021. The acquisition of Practice Partner allows Trigon Sports the ability to offer quality practice equipment to athletes at all levels of play.

BASEBALL

BASEBALL PRO REBOUNDER

Constructed of 1.5" hammered grey powder-coated steel tubing. Swaged joints for easy assembly. Heavy duty polyethylene netting with bungee cords for attachment.



Practice Partner® Pro Baseball Rebounder

PROREB

LACROSSE

LACROSSE WALL REBOUNDER

Constructed of 1.5" 18-gauge steel tubing with 4' x 3' rebounding surface.

Size: 84"T x 36"W



Practice Partner® Lacrosse Wall Rebounder

LPBT

CANVAS CATCHER THROWING TARGET

Canvas Catcher is made from vinyl and measures 48"W x 75"H. The 2 sided design can be used to practice pitching baseballs, or reversed for practicing your football passes.

Canvas Catcher Throwing Target

BDUSPORT



FRONT

BACK

NEW!

LACROSSE GOAL



Official size lacrosse goal. Formed from 18-gauge, 1.5" powder-coated steel tubing. Includes 3mm, heavy-duty weatherized netting.

Size: 72"W x 72"H x 84"D

Practice Partner®
Lacrosse Goal

LGPRAC

SILVERLINE PRACTICE LACROSSE GOAL



1.5" powder-coated orange galvanized steel frame. Net laces around frame face and ground supports. 4mm net and lacing cord.

SOLD INDIVIDUALLY.

Practice Partner® Silverline
Lacrosse Goal

SLVLG

SOCCER

SILVERLINE SOCCER GOALS



Practice Partner® Silverline
Soccer Goal 6x9

SLVSG9

Practice Partner® Silverline
Soccer Goal 6x12

SLVSG12

Practice Partner® 6'x9'
Replacement Soccer Net

SOCNET9

Practice Partner® 6'x12'
Replacement Soccer Net

SOCNET12

6X9 SOCCER REBOUNDER



Assembles to 6'H x 9'W. Precision-fit locking pins for easy assembly. Constructed of 1.5", 18-gauge heavy-duty steel tubing.

Practice Partner®
Soccer Rebounder

SOCREB

4X8 FOLDING SOCCER GOAL



Foldable goal features push-button assembly and all-weather net. Perfect portable goal for practice.

Size: 4'H x 6'W x 3'D

Practice Partner® Folding
Soccer Goal

FOLD95

HOCKEY

HOCKEY GOAL



2" galvanized steel tubing with weather-treated red powder coat. Pro style round back frame. Doubled welded net attachment system. 4mm heavy duty weatherized netting.

Practice Partner® Hockey Goal

RHX2

SILVERLINE HOCKEY GOAL



15/8" 18-gauge steel tubing with weather-treated red powder coating. Pro style round back frame. 4mm heavy duty weatherized netting.

Size: 72"W x 48"H x 36"D

Practice Partner®
Silverline Hockey Goal

SLVRHR



ROLLAWAY BATTING CAGE
BPCAGE

STANDARD FEATURES

- Overall dimensions: 22'D x 18'W x 12'H
- Collapsed storage height is 5'
- Rear dolly assembly easily lifts & maneuvers cage
- Dual, fold-out coaches platforms at rear of cage allow for raised viewing of batter
- Complete Rollaway Cage includes: Net, Heavy-duty vinyl skirt & thud pad
- Frame structure is 2" O.D. heavy wall aluminum tubing
- Large 10' x 10' baffle net to protect rear of cage
- Heavy-duty weather-treated knot-less netting - replacement net
- Replacement heavy-duty vinyl skirt (Black)
- Outer wheels turn 180 degrees and feature locking hubs with oversized turf tires

Rollaway Batting Cage **BPCAGE**

UPGRADES

- Replacement Heavy-Duty Vinyl Skirt (Black) **BPCAGESKT**
- Replacement Thud Pad (Black) **BPCAGEPAD**
- Replacement Net **BPCAGEN**

SHIPS FREIGHT. UNIT NOT DESIGNED FOR TOWING.

SKIRT & PAD WRAP COLOR KITS



COLOR	SKIRT	PAD WRAP COLOR KIT
Dark Green	BCSKTDG	BCPADDG
Purple	BCSKTPU	BCPADPU
Navy Blue	BCSKTNA	BCPADNA
Royal Blue	BCSKTRO	BCPADRO
Red	BCSKTRD	BCPADRD

Dual Fold-Out Coaches Platforms At Rear Of Cage



Color Skirt and Pad Wrap Kits Available



INDOOR CEILING SUSPENSION KIT



KIT INCLUDES:

- (3) 3/16" x 100' Galvanized Steel Wire Cables
- (30) 3/16" x 30' Galvanized Steel Wire Cables
- (66) Wire Rope Clamps
- (6) Hook & Eye Turnbuckles
- (6) 1/2" x 12" Eye-bolts
- (60) Snap Links

ProCage™ Indoor Ceiling Suspension Kit

B50015

1/4" SPRING CLIPS



1/4" Spring Clips, 42ct

SNAP42

INDOOR ELECTRIC MULTI-SPORT BATTING CAGE



Our Indoor Electric Multi-Sport Batting Cage is conveniently suspended from the ceiling structure and electrically operated. Our team will provide cut sheets to build to your specific dimensions. The drive shaft raises and lowers the system, powered by our curtain hoist. This Indoor Electric Batting Cage also comes with a 1-Year Limited Warranty. Ship time is dependent upon receipt of gymnasium dimension verification. This item includes custom-size ceiling structure only. Batting Tunnel net is NOT included. Please call for further details.

55' Custom Cage

B51055

70' Custom Cage

B51070

Pricing may vary depending on building structure

BATTING CAGE SUSPENSION/INSTALLATION KIT

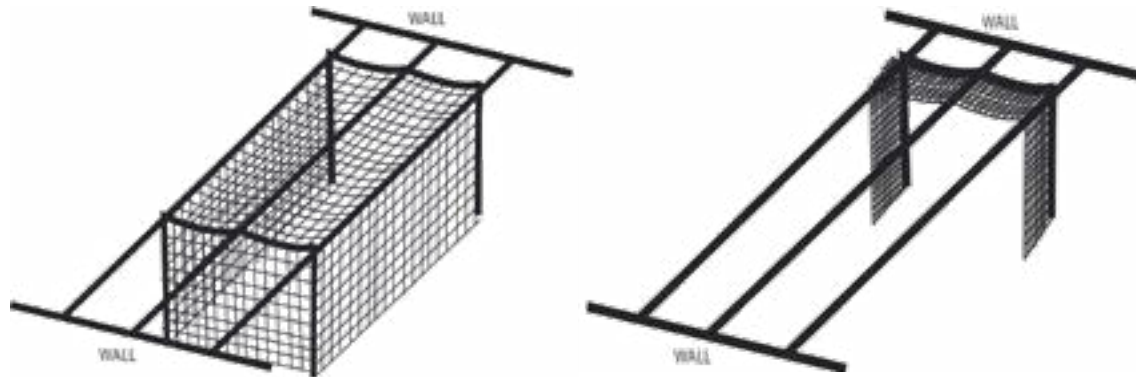

KIT INCLUDES:

- (3) 3/16" x 100' Galvanized Steel Wire Cables
- (6) Hook & Eye Turnbuckles
- (6) 1/2" x 12" Eye-bolts
- (6) Wire Rope Clamps
- (42) Snap Links

ProCage™ Batting Cage Installation Kit

B50010

Can be used for indoor suspension kit or outdoors as installation hardware for your existing frame.

CALL FOR PRICING 888-313-1303

POLY BATTING TUNNEL NETS



AVAILABLE IN BOTH #42 THREAD WITH A 5-YEAR WARRANTY AND #24 THREAD WITH A 2-YEAR WARRANTY.

Constructed of heavy-synthetic HDPE fiber, extruded with permanent black color and sunlight/UV inhibitors throughout each filament. 1-3/4" mesh size. High abrasion resistant twisted-knotted netting, strongest form of netting in commercial use. 100% waterproof and low-stretch = no sagging. Heavy-Duty rope reinforcement on all edges, corners and top hanging ropes.



NET SIZE	WEIGHT	ITEM#
75'Lx15'Wx12'H	130 lbs.	B427515
70'Lx24'Wx12'H	200 lbs.	B427024
70'Lx14'Wx14'H	125 lbs.	B427044
70'Lx14'Wx12'H	120 lbs.	B427014
70'Lx12'Wx12'H	115 lbs.	B427012
55'Lx14'Wx14'H	105 lbs.	B425544
55'Lx14'Wx12'H	100 lbs.	B425514
55'Lx12'Wx12'H	95 lbs.	B425512

INCLUDES ENTRY DOOR W/ BAFFLE

70'Lx14'Wx12'H	125 lbs.	B427014F
55'Lx14'Wx12'H	105 lbs.	B425514F

U.S. twine size as standardized by American manufacturers and the American Cordage Institute.

Do not be confused by those that refer to the thread count as U.S. twine size.



NET SIZE	WEIGHT	ITEM#
70'Lx14'Wx12'H	75 lbs.	B247014
70'Lx12'Wx12'H	70 lbs.	B247012
55'Lx14'Wx12'H	70 lbs.	B245514
55'Lx12'Wx12'H	65 lbs.	B245512
35'Lx14'Wx12'H	46 lbs.	B243514

DIVIDER NETTING

#42 Polyethylene thread with a rope border on all four sides. Attach behind batting & pitching areas to prolong net life, or hang in middle of tunnel for 2 hitting stations.



14'x12' Baffle Netting

B421412

BATTING CAGE ZIP DOOR



Add a door entry to any batting cage in minutes. Marine-grade vinyl that attaches using super stick Velcro & snaps. Simply cut an opening and attach.

Size: 70"H x 24"W with a 64" zipper door opening.

(Patent Pending)

Batting Cage Zip Door

BPZIPD

TUNNEL CAGE SAVERS

BEST SELLER!

Made of tough vinyl, lengthen the life of your batting cage nets with our cage savers. Includes brightly colored strike zone and comes with brass grommets and poly rope in corners for attachment.



Heavy-Duty 22 oz. Vinyl, 4'x6' **BSVR22**

Heavy-Duty 30 oz. Vinyl, 5'x7' **BSVR30**

Color Options: 22oz. Vinyl - Black with Red Strike Zone, 30oz Vinyl - Blue with Yellow Strike Zone, Black with Orange Strike Zone



CANTILEVER BATTING CAGE FRAME

INDIVIDUAL
POLES OR
CUSTOM
SET-UPS
AVAILABLE

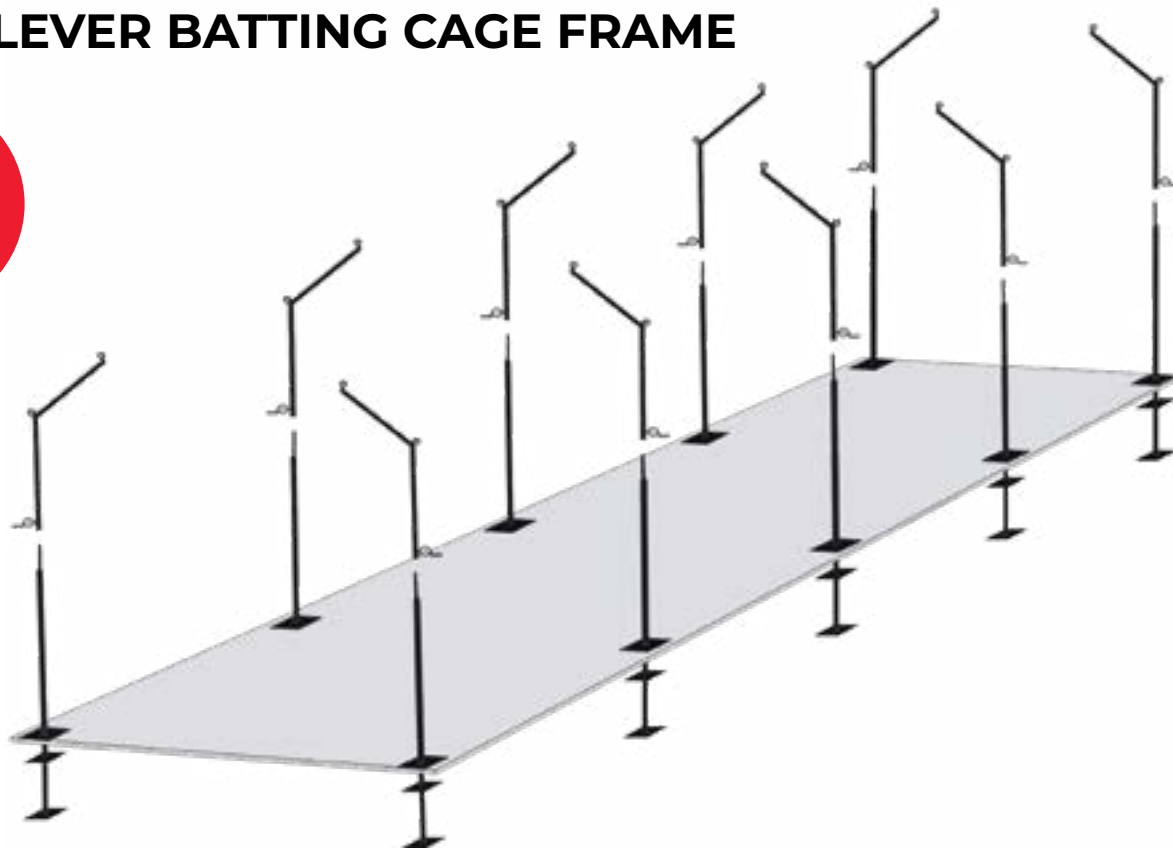

14' W x 14' H TUNNEL NET IS RECOMMENDED FOR ALL CANTILEVER CAGES.

Call us today and see how we can make this frame meet your needs.

- 8-Poles & Ground Sleeves with Hardware Kit **BCFRM55**
- 10-Poles & Ground Sleeves with Hardware Kit **BCFRM70**
- Single Pole & Ground Sleeves with Hardware Kit **BCFRM**
- 1/4" Spring Clips, 42ct **SNAP42**

New design, features 2-piece pole assembly with cantilever top and individual winch on each pole makes net set up and take down quick and easy! ***NO LADDERS NEEDED!***



PRE-CUT BARRIER NETTING



Made of Black #42 knotted thread that is weather and UV treated. 13/4" square mesh with a sewn rope border on all sides. Perfect for use as a barrier net for baseball or softball.

- 14'x50' Pre-Cut Netting **BN1450**
- 14'x100' Pre-Cut Netting **BN14100**

BASEBALL/ SOFTBALL

CUSTOM NETTING



Custom nets are made to your specification to cover any sport or application. We offer nets hung on the diamond or on the square and your choice of rope borders or vinyl tape with grommets. Please contact us with your measurements and application. Netting is our specialty!

DYNEEMA



ITEM NUMBER	CN250	CN21	CN371	CN504	CN42	CN361	CN60	CN96	CND18
Mesh Size	1"	1-3/4"	3/4"	4"	1-3/4"	1-3/4"	1-3/4"	1-3/4"	1-3/4"
Colors Available	Black	Black	Black, Blue	Black, White	Black	Black	Black	Black	Black
Cord Diameter (mm)	1.8	1.8	2.3	2.3	2.7	2.5	3.0	4.0	1.7
Applications									
Baseball Backstop					✓	✓	✓	✓	✓
Basketball Court Netting	✓	✓	✓	✓	✓	✓	✓	✓	✓
Batting Cage/Tunnel					✓	✓	✓	✓	✓
Discus Cage Netting					✓	✓	✓	✓	✓
Football Field Netting				✓	✓	✓	✓	✓	✓
Foul Ball Barrier		✓			✓	✓	✓	✓	✓
Golf Perimeter Net	✓		✓						
Golf Practice Panel/Tunnel			✓						
Hockey Barrier							✓	✓	
Indoor Baseball Facilities		✓			✓	✓	✓	✓	✓
Indoor Soccer Facilities		✓		✓	✓	✓	✓	✓	✓
L-Screen					✓	✓	✓	✓	
Lacrosse Barrier Net			✓		✓	✓	✓	✓	✓
Racquet Ball Barrier	✓	✓	✓						
Soccer Barrier		✓		✓	✓	✓	✓	✓	
Soccer Goals		✓			✓	✓	✓	✓	
Tennis Barrier/Divider	✓	✓			✓	✓	✓	✓	



PRO SCREENS

ALL PRO SCREENS FEATURE:

- Heavy-duty 4.0mm #96 thread knotted pillowcase style net
- Heavy-gauge 2" galvanized steel frame
- Heavy-duty wheel kit with no-flat turf tires
- Heavy-duty wheel protectors

8-10' FRAME PADDING KIT

3 8' Sections Vinyl w/ Lacing Twine

RECOMMENDED ON ALL SCREENS

- 7' Black Frame Padding Kit **BPROPAD**
- Green Frame Padding Kit **BPROPADGR**
- Red Frame Padding Kit **BPROPADR**
- Blue Frame Padding Kit **BPROPADBL**



PROCAGE™ "OLE 96ER" PRO L-SCREEN

8'x8'



Complete L-Screen **BLPRO96**
Replacement L-Screen Net **BLPRO96N**

PROCAGE™ "OLE 96ER" FUNGO SCREEN

8'x8'



FRAME PADDING KIT RECOMMENDED

Fits 8'-10' frame padding kits

Complete Fungo Screen **BFPRO96**
Replacement Fungo Net **BFPRO96N**

PROCAGE™ PROFESSIONAL 10'X10' PROTECTIVE SCREEN

10'x10'



FRAME PADDING KIT RECOMMENDED

Fits 8'-10' frame padding kits

Complete 10'x10' Screen **BFPRO10**
Replacement 10'x10' Net **BFPRO10N**

PROCAGE™ MINI PRO L-SCREEN

BEST SELLER!



FEATURES:

- Size: 5'W x 7'H
- Heavy-duty 4.0mm thread knotted pillowcase style net
- Heavy-gauge 2" galvanized steel frame
- Heavy-duty wheel kit with no-flat turf tires
- Heavy-duty fabric wrapped foam encases entire frame
- Heavy-duty wheel protectors

Complete Padded Mini L-Screen **BLPRO57**
Replacement Mini L-Screen Net **BLPRO57N**

PROCAGE™ PRO #96 DOUBLE L-SCREEN W/ HOOD



FEATURES:

- Size: 6' x 94" (42"W at top)
- 2' deep slanted protective hood
- Heavy duty 2" steel frame
- Heavy-duty 4.0mm thread knotted pillowcase style net
- Fully padded

Complete Double L-Screen w/ Hood

BLPRODB

NET REPAIR KIT

Net repair/lacing kit. Includes 1lb spool of black #36 tarred nylon twine and net repair lacing needle.



Net Repair/Lacing Kit

BNETREP



SUPREME SCREENS

ALL SUPREME SCREENS FEATURE:

- Double 3.0mm knotted netting
- 1.5mm heavy wall steel tubing
- 1-1/2" round hammer powder coat finish
- Push-button assembly
- Detachable legs for easy storage

7' FRAME PADDING KIT

3-7' Sections Vinyl w/ Lacing Twine

RECOMMENDED ON ALL SCREENS

- 7' Black Frame Padding Kit **B77PAD**
- Green Frame Padding Kit **B77PADGR**
- Red Frame Padding Kit **B77PADRD**
- Blue Frame Padding Kit **B77PADBL**



PITCHER'S L-SCREEN PROTECTIVE SCREEN

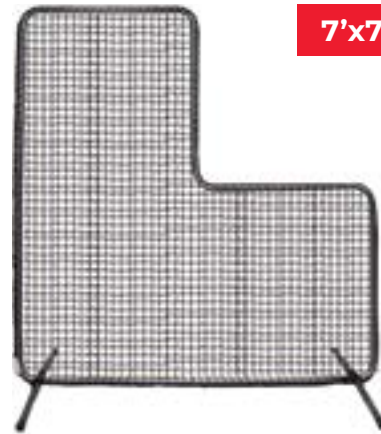

7'x7'

FRAME PADDING KIT RECOMMENDED

Fits 7' frame padding kits

- Complete Pitcher's L-Screen **B607744**
- Replacement L-Screen Net **B607744N**

FIRST BASE FUNGO PROTECTIVE SCREEN



7'x7'
#60 NETTING

FRAME PADDING KIT RECOMMENDED

Fits 7' frame padding kits

- First Base Fungo Screen **B607720**
- Replacement Screen Net **B607720N**

Z-SCREEN PROTECTIVE PITCHING SCREEN



7'x5'

FRAME PADDING KIT RECOMMENDED

Fits 7' frame padding kits (as Shown)

- Complete Z-Screen **B6075Z**

NET REPAIR KIT

Net repair/lacing kit. Includes 1lb spool of black #36 tarred nylon twine and net repair lacing needle.



Net Repair/Lacing Kit

BNETREP

PROCAGE™ UNIVERSAL WHEEL KIT



Add this wheel kit to any round or square tube screen for additional mobility on and off the field!

FITS ALL SQUARE AND ROUND TUBE FRAMES UP TO 1-3/4".

FEATURES:

- Heavy-duty steel construction
- Large turf-type wheels
- Dual clamps for secure attachment

ProCage™ Universal Wheel Kit

BWHLKIT

PREMIUM SCREENS

ALL PREMIUM SCREENS FEATURE:

- Double 2.5mm #42 pillowcase style net
- Constructed of 1-3/4" galvanized square steel frame
- Swaged joints and push-button assembly
- Detachable legs for storage

FRAME PADDING KIT RECOMMENDED

7' FRAME PADDING KIT

3-7' Sections Vinyl w/ Lacing Twine

RECOMMENDED ON ALL SCREENS

- 7' Black Frame Padding Kit **B77PAD**
 Green Frame Padding Kit **B77PADGR**
 Red Frame Padding Kit **B77PADRD**
 Blue Frame Padding Kit **B77PADBL**



PITCHER'S PROTECTIVE L-SCREEN



FRAME PADDING KIT RECOMMENDED

Fits 7' frame padding kits

- Complete L-Screen **B427744**
 Replacement Screen Net **B427744N**

PROCAGE™ MINI FUNGO SCREEN



- Complete Mini Fungo Screen **BSQ4274**
 Replacement Mini Fungo Net **BSQ4274N**
 Mini Fungo Screen Padding Kit (8 Sections vinyl w/lacing twine) **BSQ4274P**

SOFTBALL PITCHER'S PROTECTIVE SCREEN



FRAME PADDING KIT RECOMMENDED

Fits 7' frame padding kits

- Softball Pitcher's Screen **B427780**
 Replacement Screen Net **B427780N**

SOFTBALL PITCHER'S C-SCREEN



FRAME PADDING KIT RECOMMENDED

Fits 7' frame padding kits

- Softball Pitcher's C-Screen **B427790**
 Replacement C-Screen Net **B427790N**

FIRST BASE FUNGO PROTECTIVE SCREEN



FRAME PADDING KIT RECOMMENDED

Fits 7' frame padding kits

- First Base Fungo Screen **B427720**
 Replacement Screen Net **B427720N**

SOFT TOSS SOCK NET SCREEN



FRAME PADDING KIT RECOMMENDED

Fits 7' frame padding kits

- Soft Toss Sock Net Screen **B427700**
 Replacement Soft Toss Sock Net **B427700N**

FRAME PADDING KITS RECOMMENDED FOR ALL SCREENS



Heavy duty vinyl wrapped foam padding with grommets. Lacing twine is included to securely attach to square or round tube frames.



- 8'-10' Padding Kit Black **BPPROPAD**
 Green **BPPROPADGR**
 Red **BPPROPARD**
 Blue **BPPROPADBL**
 7' Padding Kit Black **B77PAD**
 Green **B77PADGR**
 Red **B77PADRD**
 Blue **B77PADBL**
 Mini Fungo Padding Kit **BSQ4274P**

CALL FOR PRICING 888-313-1303

BLACK SERIES SCREENS

PITCHER'S PROTECTIVE L-SCREEN

7'X7'
WITH 3.5'X3.5'
CUTOUT



FRAME PADDING KIT RECOMMENDED

Fits 7' frame padding kits

Complete L-Screen **BSL77P**
Replacement Screen Net **B427744N**

7'X7' FIRST BASE FUNGO SCREEN

7'X7'
#42 NETTING



FRAME PADDING KIT RECOMMENDED

Fits 7' frame padding kits

7'X7' First Base Fungo Screen **BSL77F**
Replacement Screen Net **B427720N**

ALL BLACK SERIES SCREENS FEATURE:

- Waterproof double-pillowcase netting
- Sturdy 18-gauge powder-coated 1-1/2" round steel frame
- Push-button for easy assembly
- Screen is retail packaged with UPC barcode
- Detachable legs for storage

10'X10' FIRST BASE FUNGO SCREEN

10'X10'
#42 NETTING



FRAME PADDING KIT RECOMMENDED

Fits 8'-10' frame padding kits

10'X10' First Base Fungo Screen **BSL10F**
Replacement Screen Net **BSL10FN**

SOFTBALL PITCHER'S PROTECTIVE SCREEN

7'X7'
WITH 24"X20"
CUTOUT



FRAME PADDING KIT RECOMMENDED

Fits 7' frame padding kits

7'X7' First Base Fungo Screen **BSL77SB**
Replacement Screen Net **B427780N**

SOFT TOSS SOCK NET PROTECTIVE SCREEN

7'X7'
WITH 4'X4'
SOCK OPENING



FRAME PADDING KIT RECOMMENDED

Fits 7' frame padding kits

7'X7' First Base Fungo Screen **BSL77S**
Replacement Screen Net **B427700N**

FRAME PADDING KITS RECOMMENDED FOR ALL SCREENS



Heavy duty vinyl wrapped foam padding with grommets. Lacing twine is included to securely attach to square or round tube frames.



8'-10' Padding Kit Black	BPPROPAD
Green	BPPROPADGR
Red	BPPROPADR
Blue	BPPROPADBL
7' Padding Kit Black	B77PAD
Green	B77PADGR
Red	B77PADRD
Blue	B77PADBL
Mini Fungo Padding Kit	BSQ4274P

TRI-FOLD PROTECTIVE SCREEN

8'X16'



FEATURES:

- Main panel is 8'x8' with (2) 8'x4' wings.
- Includes wheels & ground anchor stakes
- New design features four legs for added stability

OVERALL SIZE:

Our ProCage™ Tri-Fold Screen features a 1^{1/2} inch powder coated steel frame with waterproof pillowcase netting. Screen includes wheels for transport and ground anchor stakes for added stability.

Tri-Fold Protective Screen **BTRIFLD**
 Replacement Tri-Fold Screen Net **BTRINET**

TRI-FOLD 3-IN-1 NET KIT

FEATURES:

- 8'x8' sock net
- 8'x4' pitchback
- 8'x4' three-pocket catch net

OVERALL SIZE:

Main panel is 8'x8' with (2) 8'x4' wings.

Transform your tri-fold screen into a multi-purpose practice station with the Tri-fold 3-in-1 net kit. Each panel is made with a durable waterproof #42 pillowcase style netting.



Tri-Fold Multi Purpose Net Kit **BT3N1**

***INCLUDES NET ONLY,
 FRAME SOLD SEPARATELY.***

BATTING PRACTICE BALL CADDY



Caddy can be used while sitting or standing by easily adjusting leg height. Legs adjust to 24", 30" and 36" heights. Comes with wheels for easy transport on and off the field. Holds up to 60 baseballs or 36 softballs.

Batting Practice Ball Caddy **BPCAD**
 Replacement Bag **BPCADMB**

PROCAGE PROFESSIONAL BALL CART

PRO'S CHOICE



HD powder-coated steel frame with a premium mesh netted ball basket. Sturdy and durable with no-flat turf tires. NEW wheel protectors. Push-button assembly. Dolly-style design for easy transport. Holds 300 baseballs and approximately 150 softballs. Great for all levels of play.

ProCage Professional Ball Cart **BPCADP**
 Replacement Net **BPCADPN**

TRAINING AIDS

THE DESIGNATED HITTER



Life-like, silhouette figure of a batter stands in at the plate in place of a real batter, adding the element of a more game-like setting to pitching practice.

Available in: **Red, Blue and Gray**

Designated Hitter
Pro Model

DHPRO



STANDARD BATTING TEE



Mounted on an official rubber home plate. Molded rubber design with inner steel support tube. Inner sleeve adjusts from 22" to 47" to accommodate batters of all sizes.

Standard Batting Tee

BBTEE

DELUXE BATTING TEE



Mounted on an official rubber home plate. Features a reinforced tube base. Inner sleeve adjusts from 22" to 47" to accommodate batters of all sizes. Molded rubber design features a built-in carry handle.

Deluxe Batting Tee

BDTEE

FOLDING BATTING TEE



Molded rubber design. Adjustable height from 30"-46". Folding base makes it travel easy.

Folding Batting Tee

BFTEE

HANGING BALL HOLDERS



Features an all steel, welded construction powder-coated black for maximum protection. Holders store up to 10 balls.

Baseball Holder

BBHLD

Softball Holder

SBHLD

HANGING BAT RACK



All steel construction, powder-coated black for maximum protection. Hanging arms swivel for easy use and storage. Rack holds 10 bats.

Size: 30" wide

Hanging Bat Rack

BHRACK

9-HOLE PITCHING TARGET TRAINER

BEST SELLER!



FEATURES:

- Size: 46"H x 36"W
- Target zone: 42"H x 36"W
- 2" steel frame
- Knotless nylon netting with nine netting pockets
- Vinyl padding with yellow target zone

9-Hole Pitching Trainer
9-Hole Pitching Trainer
Replacement Net

BPTRAIN9
BPTRAIN9N

PRO ADJUSTABLE 9-HOLE TARGET



FEATURES:

- Target zone: 30"H x 26"W
- 2" steel frame
- Adjusts to three height settings up to 4'
- Knotless nylon netting with nine netting pockets
- Vinyl padding with yellow target zone
- Ideal for evaluating pitcher accuracy at all skill levels

Pro Adjustable 9-Hole Target Pitch Trainer **BPTRAIN9PRO**

MULTI-SPORT PITCH BACK REBOUNDER

BEST SELLER!



1¹/₄" hammered grey powder coated steel tubing. Swaged joints with thumb snaps for easy assembly. Adjustable to multiple angles for play on both sides. Heavy-duty polyethylene netting with bungee cords for attachment. Includes a 1" red target interlaced into netting.

Size: 72"T x 42"W

Multi-Sport Pitch Back Rebounder
Multi-Sport Pitch Back Rebounder
Replacement net

MSPB427

MSPB427N

PRACTICE PARTNER.

BASEBALL PRO REBOUNDER



Constructed of 1.5" hammered grey powder-coated steel tubing. Swaged joints for easy assembly. Heavy duty polyethylene netting with bungee cords for attachment.

Practice Partner® Pro Baseball Rebounder

PROREB

BASEBALL/ SOFTBALL



I-HACK ATTACK BASEBALL PITCHING MACHINE



TOUCH SCREEN INTERFACE:

With the familiar look and feel of a personal tablet, the machine interface is a customized touch screen through which you can control and select pitch type, speed and spin as well as access saved favorite pitches and sequences.

ADVANCED SOFTWARE PROGRAM:

Using touch screen, quickly go between eight different pre-set pitches as well as pre-set defensive drills.

All pitches can be modified as desired by making finite adjustments to each motor individually.

FEATURES:

- Great for all levels of baseball.
- Throws fastballs, curves, sliders, split fingers and Knuckleballs.
- Pivots instantly for pop-ups, flyballs, grounders and catcher's pop-ups.

I-Hack Attack Baseball Pitching Machine **BIHACK**

HACK ATTACK PITCHING MACHINE



The exclusive three-wheel design of the Hack Attack Baseball Pitching Machine allows the hitter to see the ball clearly all the way through the feeding motion, acceleration and release, just like with a live pitcher.

FEATURES:

- Can be used for all levels of baseball.
- Throws fastballs, curves, sliders, split fingers and Knuckleballs.
- Pivots instantly for pop-ups, flyballs, grounders and catcher's pop-ups.
- Can be converted to softball.

Hack Attack Baseball Pitching Machine **BHABSBL**

JUNIOR HACK ATTACK PITCHING MACHINE



The Junior Hack Attack Baseball Pitching Machine is the major-league quality training tool designed to develop serious young players.

FEATURES:

- Great for all levels of baseball or softball.
- Throws fastballs, curves, sliders, split fingers and Knuckleballs.
- Pivots instantly for pop-ups, flyballs, grounders and catcher's pop-ups.

Junior Hack Attack Baseball Pitching Machine **BHAJRBB**
Junior Hack Attack Softball Pitching Machine **BHAJRSB**

FOUL POLES

20' TWO-PIECE DESIGN FOUL POLES

BEST SELLER!

Complies with NCAA Rule 2.12 for Softball Foul Poles.

Heavy-duty foul pole constructed of 3.5" OD powder-coated steel. Expanded metal wing panels are 1^{1/2}' x 12'. 24' poles are placed 4' into the ground. Optional galvanized steel ground sleeves available.

- White 20' Two-Piece Design Foul Pole **BFPOLE20CW**
- Yellow 20' Two-Piece Design Foul Pole **BFPOLE20C**
- 4' Ground Sleeve **BFPSLVE20**

20' WHITE

20' YELLOW

4' GROUND SLEEVE

CUSTOM FOUL POLE BANNERS

Spruce up your field with custom foul pole banners designed to fit your existing foul pole wings. Sold in 14 oz promesh windscreen with full graphics included.

SOLD IN PAIRS.

Size: 18" x 12'

Foul Pole Banners (Pair)

BFLBANNER

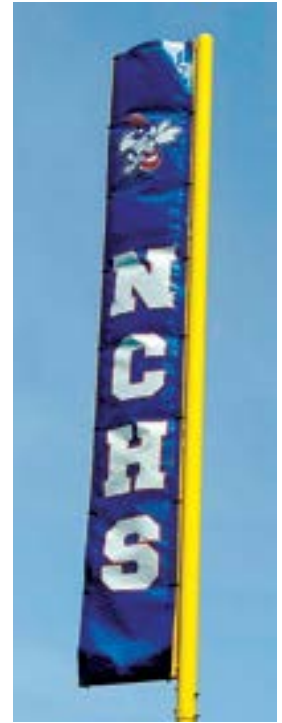

BASEBALL/ SOFTBALL

FIELD BANNERS



- Outfield distance markers and other field banners are printed digitally with 14 oz. reinforced vinyl fabric.
- Available with numerals and background colors of your choice.
- Specify distances when ordering!

- 56" H x 20" L (12" Numerals) **BVDB12**
- 27" H x 36" L (14" Numerals) **BVDB14**
- 38" H x 56" L (24" Numerals) **BVDB24**



CALL FOR PRICING 888-313-1303

HALO KITS



Turf halo kits are used on baseball and softball fields, to outline the area behind home-plate. A top-of-the-line protective halo kit will keep this area from being worn out from foot traffic and save money on grass maintenance. Halo kits are also an interesting way to display logos, team or event names, sponsors or memorials.

FEATURES:

- High-grade, spike resistant durable turf
- Designed to fit 36' diameter home plate areas
- Available in 5' or 10' widths and come with unitary (without shock pads) or 5mm foam backing for shock absorption.
- Extension wings available in 5' or 10' lengths.
- Available in standard green or a variety of other colors.
- All custom artwork is inlaid with colored turf.

Halos require a concrete or asphalt slab that should cure for no less than 2 weeks prior to installation

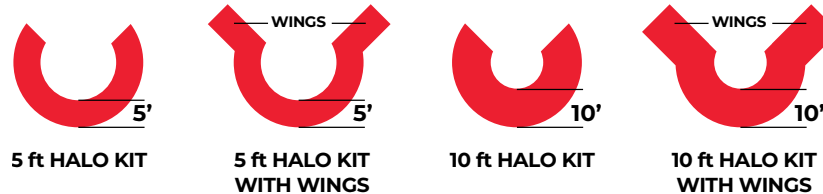

KIT	NO WINGS	WINGS
5' Home Plate Halo Kit	BTHALO5	BTHALO5W
5' Home Plate Halo Kit & Padding	BTHALO5F	BTHALO5FW
10' Home Plate Halo Kit	BTHALO10	BTHALO10W
10' Home Plate Halo Kit & Padding	BTHALO10F	BTHALO10FW
Solid Color Lettering - 5' Halo	BTHCOL5	
Solid Color Lettering - 10' Halo	BTHCOL10	
Two-Color Lettering - 5' Halo	BTHLT5	
Two-Color Lettering - 10' Halo	BTHLT10	

TURF CLAW FB TURF ADHESIVE



Turf Claw FB is solvent-free, low odor and designed for the permanent installation of rubber backed and urethane backed carpets, underlayment and flooring.

Four-Gallon Bucket,
Turf Claw FB Turf Adhesive

BTADH

OXYTURF CLEANER & DISINFECTANT



A one-step, non-acid, ready-to-use, non-abrasive, synthetic turf cleaner & disinfectant. Removes grease & grime. Kills 99.9% of germs, viruses, & bacteria. Patented stabilized Hydrogen Peroxide Technology. Oxygenated cleaning & deodorizing. Good for 4+ years of shelf life. **55 GALLONS WILL CLEAN A WHOLE FOOTBALL FIELD!**

One-Gallon Jug with
Battery Powered Sprayer

TCOT001BPS

Six Gallon Pail

TCOT006

55-Gallon Drum

TCOT0055



PRO TURF MATS

Looking to step up your game with some Pro Turf? Look no further than Trigon Sports. We offer a range of bat mats to suit your needs, including home plate mats, on-deck circles and batter's box mats. Or, if you need Pro Turf for pitchers, check out our pitcher's mats. To fill a larger space, there's turf by the roll as well.

All Pro Turf mats are constructed of top quality spike-proof turf with a 5mm shock absorbing cushion.

TURF ON DECK CIRCLES



Made of spike-proof turf with a 5mm shock absorbing cushion, our top-of-the-line on-deck circles give the upcoming batter their specific space to warm up. Mats can be customized with team logos or sponsors to help your team and field look and play like the pros.

Available in a variety of colors, or you can send your custom artwork to sales@trigonsports.com for a quote.



- Green 6' Diameter **BTMOD6**
- Clay 6' Diameter **BTMOD6CL**
- Green 4' Diameter **BTMOD4**
- Clay 4' Diameter **BTMOD4C**
- Custom Color 6' Diameter **BTMOD4CC**
- Custom Color 6' Diameter **BTMOD6CC**

PRO-DECK DIGITAL PRINT ON DECK CIRCLES



Constructed using an all-weather memory foam and super thick spike resistant PVC surface.

60" Pro-Deck Circle **PDODC60**

HOME PLATE MATS

PRO'S CHOICE



Give pitchers a clear reference with a turf home plate mat. Protect your batters box and home plate area. Available in a variety of colors to customize your practice space.

- 6'x12' Green Home Plate Mat **BTM612**
- 7'x12' Green Home Plate Mat **BTM712**

- 6'x12' Clay Home Plate Mat **BTM612C**
- 7'x12' Clay Home Plate Mat **BTM712C**
- 6'x12' Red Home Plate Mat **BTM612RD**
- 6'x12' Orange Home Plate Mat **BTM612OR**
- 6'x12' Brown Home Plate Mat **BTM612BR**
- 6'x12' Blue Home Plate Mat **BTM612BL**
- 6'x12' Black Home Plate Mat **BTM612BK**

BATTER'S BOX MATS

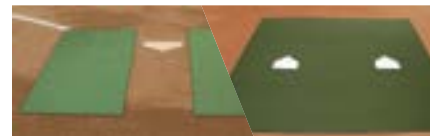

Protect and prevent digouts quickly and economically with a turf batter's box mat.

- 4'x6' Baseball Batter's Box Mat **BTMB46**
- 3'x7' Softball Batter's Box Mat **BTMB37**
- 12'x12' Batting Mat - Includes two throw-down home plates **BTBM12**

PITCHER'S MATS









Prevent time-consuming mound maintenance by covering it with a turf pitching mat during pitching practice.

- 4'x12' Pitching Mat **BTMP412**
- 6'x12' Pitching Mat **BTMB37**

CUSTOM TURF

Pro Turf is perfect for a variety of surfaces including indoor sports facilities, outdoor sports fields, and batting cages and stands up to light steel cleat traffic. The synthetic option offers years of play, low maintenance and performance of the best kept grasses. Urethane and foam backed turf can be glued down for permanent installations on concrete or asphalt. Foam backing gives excellent shock absorbency & durability. Our proven synthetic turf surfaces are ideal for indoor and outdoor soccer fields, football fields, baseball fields, multi-purpose fields, lacrosse, and more!

MINIMUM ORDER OF 180 SQUARE FEET (15' X 12'). COLORS & STYLES MAY VARY

TURF STYLE	ITEM #	FACE WEIGHT	PILE HEIGHT	WIDTH	BACKING	SUGGESTED USE
Standard	 BTPL357U	24 oz.	1/4"	15'	Urethane	Medium-use turf.
	 BTPL357S	24 oz.	1/4"	15'	5mm Foam	Withstands light steel cleat traffic.
	 BTPL3573	24 oz.	1/4"	15'	3mm Foam	<i>MOST POPULAR TURF FOR INDOOR FACILITIES</i>
Supreme	 BTPL705U	36 oz.	9/16"	15'	Urethane	<i>MOST POPULAR TURF FOR OUTDOOR BATTING CAGES</i>
	 BTPL705S	36 oz.	9/16"	15'	5mm Foam	High quality, durable turf. Ideal for batting cages, bullpens & dugouts. Withstands steel cleats.
Premier	 BTAT740U	40 oz.	3/4"	15'	Urethane	Most popular turf for sports fields and arenas. Most durable turf. Stands up to heavy steel cleat traffic.
	 BTAT740S	40 oz.	3/4"	15'	5mm Foam	

*Turf home plate & pitching mats should be used in high traffic & batting areas to prolong turf life. Actual colors of turf may vary from images above. All turf ships truck freight.

TURF CLAW FB TURF ADHESIVE



Turf Claw FB is solvent-free, low odor and designed for the permanent installation of rubber backed and urethane backed carpets, underlayment and flooring.

Four-Gallon Bucket, Turf Claw FB Turf Adhesive

BTADH

OXYTURF CLEANER & DISINFECTANT



A one-step, non-acid, ready-to-use, non-abrasive, synthetic turf cleaner & disinfectant. Removes grease & grime. Kills 99.9% of germs, viruses, & bacteria. Patented stabilized Hydrogen Peroxide Technology. Oxygenated cleaning & deodorizing. Good for 4+ years of shelf life. ***55 GALLONS WILL CLEAN A WHOLE FOOTBALL FIELD!***

One-Gallon Jug with Battery Powered Sprayer

TCOT001BPS

Six Gallon Pail

TCOT006

55-Gallon Drum

TCOT0055

PORTABLE PITCHER'S MOUNDS

PREP GAME MOUND



FEATURES:

- Size: 9'L x 4'W x 6"H
- Spike-proof artificial turf with 1-Year limited warranty
- Non-slip, non-marking, rubber backing
- Lightweight, portable, high strength construction
- Shock absorbing landing area
- For pitching distances of 54' or less

Green Prep Game Mound **B417000**
Clay Prep Game Mound **B418000**

TAPERED PREP MOUND



FEATURES:

- Size: 9'L x 4'W x 6"H
- Spike-proof artificial turf with 1-Year limited warranty
- Non-slip, non-marking, rubber backing
- Lightweight, portable, high-strength construction
- Shock absorbing landing area
- For pitching distances of 54' or less
- Tapered sides allow pitcher's to throw to all bases

Green Tapered Prep Mound **B817000TC**
Clay Tapered Prep Mound **B818000TC**

COLLEGIATE PREP PITCHER'S MOUND



FEATURES:

- Size: 9'6"L x 4'W x 10"H
- Spike-proof artificial turf with 1-Year limited warranty
- Non-slip, non-marking, rubber backing
- Lightweight, portable, high strength construction
- Shock absorbing landing area

Green Collegiate Prep Mound **B417002**
Clay Collegiate Prep Mound **B418002**

PRO PRACTICE PITCHER'S MOUND

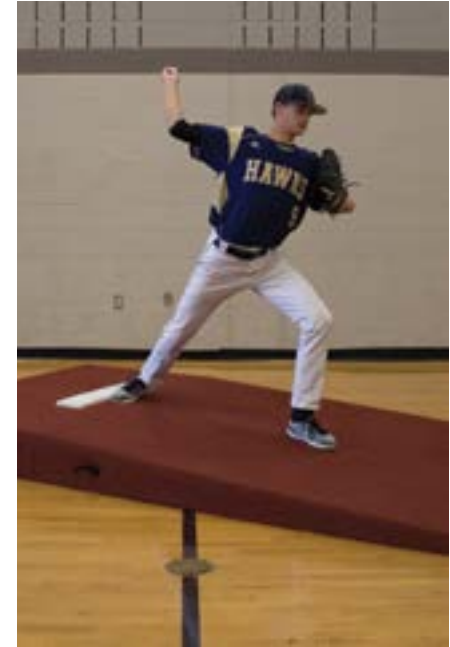

FEATURES:

- Size: 9'6"L x 5'4"W x 10"H
- Spike-proof artificial turf with 1-Year limited warranty
- Non-slip, non-marking, rubber backing
- Lightweight, portable, high strength construction
- Shock absorbing landing area

Green Pro Practice Mound **B417003**
Clay Pro Practice Mound **B418003**

JUNIOR GAME MOUND



FEATURES:

- **Size:** 9'L x 5'4"W x 6"H
- Spike-proof artificial turf with 1-Year limited warranty
- Non-slip, non-marking, rubber backing
- Lightweight, portable, high strength construction
- Shock absorbing landing area
- For pitching distances of 54' or less

Green Junior Game Mound **B417001**
 Clay Junior Game Mound **B418001**

TAPERED JUNIOR GAME MOUND



FEATURES:

- **Size:** 9'L x 5'4"W x 6"H
- Spike-proof artificial turf with 1-Year limited warranty
- Non-slip, non-marking, rubber backing
- Lightweight, portable, high strength construction
- Shock absorbing landing area
- For pitching distances of 54' or less
- Tapered sides allow pitchers to throw to all bases

Green Junior Game Mound **B817001TG**
 Clay Junior Game Mound **B818001TC**

PRO PITCHER'S GAME MOUND



FEATURES:

- **Size:** 11'6"L x 8'3"W
- Spike-proof artificial turf with 1-Year limited warranty
- Non-slip, non-marking, rubber backing
- Lightweight, portable, high strength construction
- Shock absorbing landing area
- For pitching distances of 60'6"

Green 8" Pro Game Mound **B817004**
 Clay 8" Pro Game Mound **B818004**
 Green 10" Pro Game Mound **B417004**
 Clay 10" Pro Game Mound **B418004**

TAPERED PRO GAME MOUND



FEATURES:

- **Size:** 11'6"L x 8'3"W
- Spike-proof artificial turf with 1-Year limited warranty
- Non-slip, non-marking, rubber backing
- Lightweight, portable, high strength construction
- Tapered sides allow pitchers to throw to all bases

Green 8" Tapered Pro Game Mound **B807004**
 Clay 8" Tapered Pro Game Mound **B808004**
 Green 10" Tapered Pro Game Mound **B107004**
 Clay 10" Tapered Pro Game Mound **B108004**

All Mounds Ship Freight.

BATTING PRACTICE PITCHING PLATFORM



FEATURES:

- **Size:** 7'L x 4'W
- Spike-proof artificial turf with 1-Year limited warranty
- Lightweight, portable, high strength construction
- Shock absorbing landing area
- Wheels for easy transportation on & off field

Batting Practice Pitching Platform

B417016

PONY PITCHING MOUND



FEATURES:

- **Size:** 54"L x 49"W x 6"H
- Weighs 50 lbs.
- Easy to move & store
- Fully turfed with regulation pitching rubber
- Tapered sides allow pitchers to throw to first and third base

Green Pony Pitching Mound **B417020**

Clay Pony Pitching Mound **B418020**

JUNIOR TRAINING PITCHING MOUND



FEATURES:

- **Size:** 42"L x 42"W x 4"H
- Great for working on mechanics & pickoffs
- Portable, lightweight design for transport anywhere

Green Junior Training Mound **B419005**

Clay Junior Training Mound **B419006**

2-PIECE INDOOR PITCHING MOUND

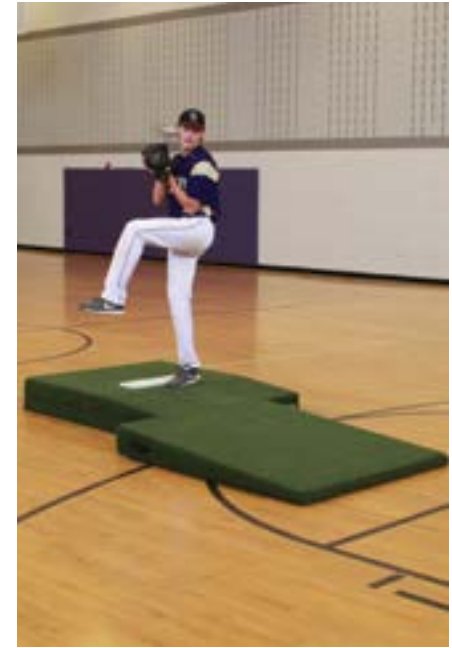

FEATURES:

- **Size:** Collegiate - 9'6"L x 4'W x 10"H
Pro - 9'6"L x 5'4"W x 10"H
- Two-piece design for easy moving & storage
- Interlocking sections allow bottom piece to be offset
- Will not damage or scratch gym floors

Green Collegiate 2-Piece Mound **B417030**

Clay Collegiate 2-Piece Mound **B418030**

Green Pro 2-Piece Mound **B417032**

Clay Pro 2-Piece Mound **B418032**

JUNIOR PRO MOUND



FEATURES:

- **Size:** 6'L x 42"W x 6"H
- Great for working on mechanics & pickoffs
- Portable, lightweight design for transport anywhere

Green Junior Pro Mound **B419002**
Clay Junior Pro Mound **B419003**

TAPERED JUNIOR PRO MOUND



FEATURES:

- **Size:** 6'L x 42"W x 6"H
- Great for working on mechanics & pickoffs
- Portable, lightweight design for transport anywhere

Green Tapered Junior Pro Mound **B819002TC**
Clay Tapered Junior Pro Mound **B819003TC**

FOLD 'N' ROLL MOUND



FEATURES:

- **Size:** Collegiate - 9'6"L x 4"W x 10"H
Pro - 9'6"L x 5'4"W x 10"H
- Lightweight, portable design with spike-proof artificial turf
- Non-slip, non-marking, rubber backing
- Regulation slope for learning proper mechanics
- Folds up & rolls away in seconds

Green Collegiate Fold 'n' Roll Mound **B417002F**
Clay Collegiate Fold 'n' Roll Mound **B418002F**
Green Pro Fold 'n' Roll Mound **B417003F**
Clay Collegiate Fold 'n' Roll Mound **B418003F**

SOFTBALL PITCHING MATS



FEATURES:

- **Sizes:** 3'W x 10'L & 3' x 3'
- Spike-proof artificial turf
- Non-slip, non-marking, rubber backing
- Permanent pitching rubber

3' x 3' Mini Pitching Mat **B417026**
3' x 10' Pitching Mat with Stride Line **B417010**
3'x10' Pitching Mat without Stride Line **SBPM310**

HOME PLATES & PITCHING RUBBERS

PROFESSIONAL HOME PLATE



Professional anchor-style home plate. Includes ground anchor.

Professional Home Plate **BHPML**

MOLDED RUBBER HOME PLATE



Professional anchor-style home plate. Includes ground anchor.

Molded Rubber Home Plate **BHPMR**

LOW PROFILE HOME PLATE

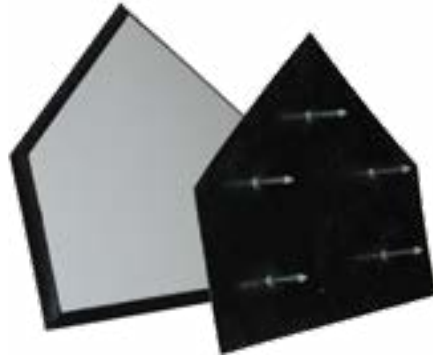

Low-profile home plate sold with ground spikes for in-ground system. Includes ground spikes.

Low Profile Home Plate **BHPSL**

WAFFLE BOTTOM HOME PLATE



Professional bury-all home plate with waffle bottom.

Waffle Bottom Home Plate **BWBHP**

WOOD BOTTOM HOME PLATE

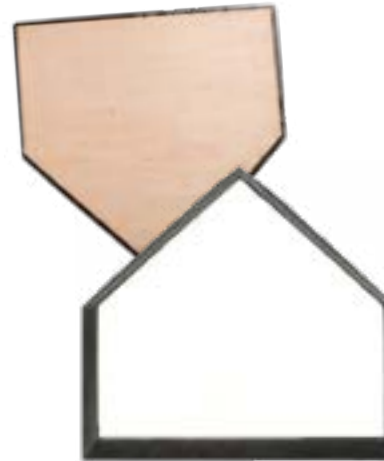

Solid wood filling with beveled outer edge.

Wood Bottom Home Plate **BHPWD**

THROW DOWN HOME PLATE



Heavy-duty rubber home plate with waffle bottom and beveled edges.

Throw Down Home Plate **BDHPW**

STRIKE ZONE HOME PLATE



Heavy-duty rubber home plate with painted strike zones.

Strike Zone Home Plate **BSTRKHP**

THROW DOWN CLEAT CLEANER

PRO'S CHOICE



Features 88 tough rubber bristles that quickly & easily remove dirt & debris from cleats. Holes in each corner for stake-down option.

12" x 11" Throw Down Cleat Cleaner **BHDRCC**

CALL FOR PRICING 888-313-1303

STEP DOWN PITCHING RUBBER

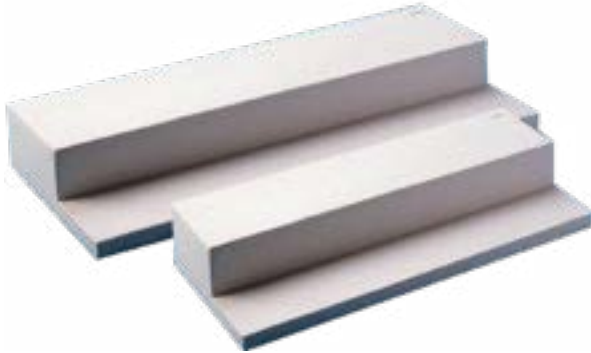

Official size with solid wooden core and molded rubber cover.

6" x 24" Step Down Pitching Rubber
4" x 18" Youth Step Down Pitching Rubber

BPPSD
BPPSDJ

4-WAY PITCHING RUBBERS



Heavy-duty rubber with a hard inner support tube. Pitching rubber can be rotated for use on all four sides.

6" x 24" 4-Way Pitching Rubber
4" x 18" Youth 4-Way Pitching Rubber

BPP4W
BPP4WJ

IN-GROUND ANCHOR POST



Removable in-ground anchor system for pitching plate.

PITCHING PLATE SOLD SEPARATELY!

Official Size In-Ground Anchor
Youth In-Ground Anchor Post

BIGPPAP
BIGPPAPJ

PITCHING PLATE



Pitcher's plate sold with ground spikes for in-ground system.

PITCHER'S PLATE & ANCHOR SYSTEM SOLD SEPARATELY!

6" x 24" Pitching Plate
4" x 18" Youth Pitching Plate

BIGPP
BIGPPJ

BASE SETS

HOLLYWOOD STYLE BASE SET

BEST SELLER!



Hollywood style professional anchored 3-base set.

SET INCLUDES:

- 3 Bases
- 3 Anchors
- 3 Plugs

Hollywood Style Base Set

BMLBS

18" PROFESSIONAL BASE SET



18" Professional style anchored 3-base set.

SET INCLUDES:

- 3 Bases
- 3 Anchors
- 3 Plugs

18" Professional Base Set

BMLBS18

MOLDED RUBBER BASE SET

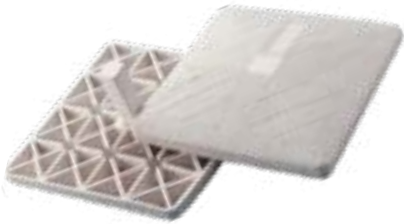

15" x 15" x 2" molded rubber bases.

SET INCLUDES:

- 3 Bases
- 3 Anchors
- 3 Plugs

Molded Rubber Base Set

BMRBS

MAGNETIC BREAK-FREE BASE



Each base includes molded rubber cover, stanchion, ground anchor with magnetic fixture and three galvanized steel plates for different resistance.

PRICED AND SOLD PER BASE!

Magnetic Break-Free Base

BBMAC

GROUND ANCHORS

1 1/2" (Female opening) x 8" long. For all bases & plates that utilize a 1 1/2" anchor system. Sold in Sets of 3.



Ground Anchors (Set of 3)

BMLANCH

PRO DOUBLE FIRST BASE



Professional Double First Base features one-piece molded rubber construction. Comes complete with ground anchors and plugs.

Size: 30" x 15" x 2.5"

Pro Double First Base

BDFBML

THROW DOWN BASE SET



Heavy-duty rubber bases with a waffle bottom and beveled edges. Set includes 3 bases.

Throw Down Base Set

BWBBS

DIGOUT TOOL



Features steel construction with wooden handle. Easily cleans dirt from ground anchors.

Digout Tool

BDOUT

BASE CADDY



NEW!

Heavy duty transport caddy for 1 set of bases and dig out tool. Constructed of all steel components and no flat wheels. Will be able to transport bases up to 18" square that use square hollow stem. Bases not included.

Base Caddy

BBCAD

FLAT RUBBER THROW DOWN BASE SET



Durable flat rubber base set. Set includes 3 bases, pitching rubber and home plate.

Flat Rubber Throw Down Base Set

BWBBS2

FEATHERED BASE PLUGS



Big league base plugs fit snug to keep dirt & debris out of your base anchors. Feathered design allows drags to be pulled directly over plugs without damage.

Feathered Base Plugs (Set of 4)

BFPLUGN

RUBBER BASE PLUGS

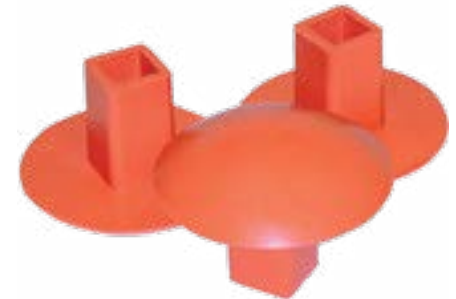

Rubber base plugs fit snug to keep dirt & debris out of your base anchors.

PRICED AND SOLD PER PLUG!

Rubber Base Plug

BDPLUG

DIRT PRODUCTS

10 BAG MINIMUM ON ALL DIRT - MIX AND MATCH

MOUND CLAY



High-density red clay material used in high wear areas on the mound (toe and landing areas) or in the batter's boxes. Screened at 1/2" to remove debris and "sift" the material. Available in 50 lb. bags or bulk. Please call for bulk pricing.

Mound Clay **MCLAY**

ATHLETIC FIELD SURE DRY



Calcined clay material native to the North Mississippi area. Absorbs moisture and helps reduce slick spots on the mound, plate areas or around the bases. Available in 50 lb. bags or bulk. Please call for bulk pricing.

Sure Dry **SUREDRIY**

ALL PRO PLUS CHALK



High-quality marble dust for marking athletic fields. Complies with the "Safe Use" requirements of the Consumer Safety Act and NCAA rules for athletic marking materials. Available in 50 lb. bags.

All Pro Plus Chalk **CHALK**



FIELD CONDITIONERS

FIELD CONDITIONER APPLICATION FOR SKINNED AREAS

Field Size	Infield Type	Quantity
Baseball		
95 Foot Radius	Grass Infield Only	40-80 Bags
95 Foot Radius	Grass Infield (6' Baseline)	60-80 Bags
Softball		
65 Foot Radius	Skinned w/ Grass Apron	40-80 Bags
65 Foot Radius	All Skinned	80-120 Bags
Youth		
50 Foot Radius	Grass Infield Only	40 Bags
50 Foot Radius	Grass Infield - 4' Baseline	50 Bags
50 Foot Radius	All Skinned	80-120 Bags



COMPARE TO TURFACE MVP 516

COMPARE TO TURFACE ELITE 816

Field conditioner absorbs excess moisture to keep field consistently playable. Field conditioners can be used to help reduce compaction in high traffic areas in your turf grass or as a top dressing material for your football, soccer, and outfield turf grass. Available in two particle sizes, 516 and 816. Available in 50 lb. bags or bulk.

Mule Mix 516 Conditioner **MULE516**
 Mule Mix 816 Conditioner **MULE816**

PUDDLE PILLOW



ABSORBS STANDING WATER

Remove small puddles on your field quickly. Place pillows in standing water and when pillows are saturated, squeeze out absorbed water. Can be reused multiple times! 10 pillows per case. Each pillow can absorb up to 3.5 liters of water.

Puddle Pillow **PILLOW**

FIELD MAINTENANCE

PRO FIELD RAKE

BEST SELLER!



All aluminum construction designed for institutional use. Durable and lightweight with oversized teeth. Use one side to rake and the other side to level.

- 24" Head-width Pro Field Rake **BRAKE24**
- 36" Head-width Pro Field Rake **BRAKE36**
- 48" Head-width Pro Field Rake **BRAKE48**

DUAL PURPOSE RAKE



Features two teeth designs. Short teeth for breaking up hard clay, while the long teeth are for wet clay and general raking. 66" powder-coated aluminum handle with 6" non-slip vinyl grip provides extra comfort.

- 24" Head-width Dual Purpose Rake **BRAKE24DP**
- 36" Head-width Dual Purpose Rake **BRAKE36DP**

PRO TURF LUTE RAKE



Lightweight design is perfect for spreading dirt, gravel or for grading soil. Comes with 82" powder-coated aluminum handle in 24" or 36" head widths.

- 24" Head-width Pro Turf Lute Rake **BRAKELT24**
- 36" Head-width Pro Turf Lute Rake **BRAKELT36**

INFIELD LIP BROOM



Heavy-duty 28" head with scarifying edge and two rows of removable bristles. Powder-coated aluminum handle is bent to reduce back strain.

- Infield Lip Broom **BLPBROOM**

7' DOUBLE PLAY MONSTER DRAG BROOM



7' head with A-frame padded handle with hooks for hanging. Short teeth for breaking up hard, dry clay.

- 2 Rows of Bristles w/ Scarifying Teeth **BMBROOM2**
- 3 Rows of Bristles **BMBROOM3**

COCOA/MOUND MOP



High-quality 1" thick cocoa material with a heavy-duty vinyl backing. Excellent for mounds and areas that require tight maneuvering.

- 24" x 16" Cocoa Mound Mop **BCMOP24**

STEEL FLEX DRAG MOP



Designed to finish grooming small areas. Powder-coated aluminum handle is 66" long with aluminum head and wrap around bracing.

24" x 18" Steel Flex Drag Mop

BSFDM

FINISHER MOP

NEW!



All rubber finishing mop for mounds and other areas that require tight maneuvering.

24" x 18" Finisher Mop

FINMOP

NON-ABSORBENT ROLLER SQUEEGEE



36" head with 60" aluminum handle. Great for pushing water off of hard surfaces.

Roller Squeegee
Replacement Roller

TNRLR36
TNRLR36R

DIRT TAMP



Designed for rugged use. No more broken handles with our solid welded steel construction. 48" Handle with 12" solid vinyl grip.

Dirt Tamp

BTAMP10

LOOP HOE



Double knife edge rocks back and forth with a push/pull motion. Fiberglass handle.

Loop Hoe

BLPHOE

SIFTING SCOOP



Designed to finish grooming small areas. Powder-coated aluminum handle is 66" long with aluminum head and wrap around bracing.

14" x 17" Sifting Scoop

SSCOOP

DRAG MATS

ALL STEEL DRAG MATS

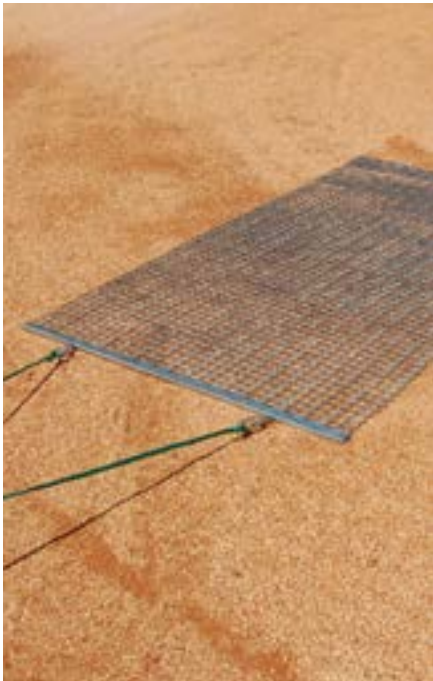

All steel drag mats come complete with drag bar and rope with handle. Perfect for grooming and general field maintenance.

- 3'W x 5'L Drag Mat **BDMAT35**
- 6'W x 3'L Drag Mat **BDMAT63**
- 6'W x 6'L Drag Mat **BDMAT66**

MONSTER DRAG MATS

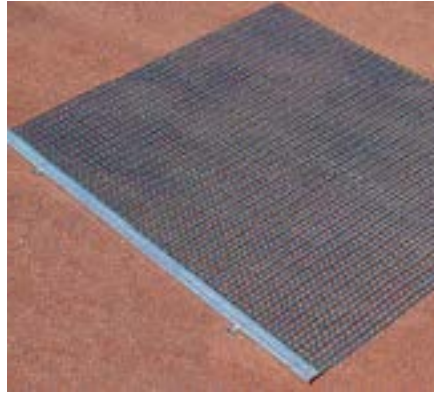

Deluxe mat construction utilizes 1/2" x .062 mesh with 6 gauge connecting rods, each welded on end. Includes angle iron front with welded eye bolts for you to attach your chain. Mat cannot separate & will last for years!

- 6'W x 4'L Drag Mat **BDMATM64**
- 9' Drag Chain **CHAIN**

RIGID DRAG MATS

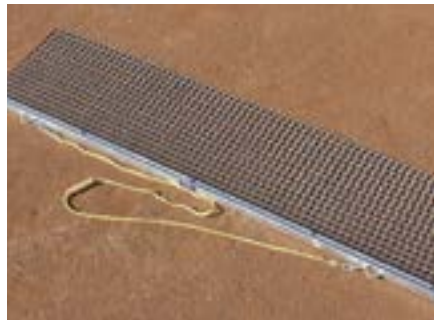

1" x 1" mesh, 13 gauge galvanized connecting rods. Mesh is rotated 90 degrees to make mat rigid. Rigid mats can **NOT** be rolled up for storage. Includes heavy-duty angle iron and a rope and handle for pulling.

- 4'W x 18"L Rigid Drag Mat **BDMR418**
- 6'W x 18"L Rigid Drag Mat **BDMR618**

STEEL BOLT DRAG

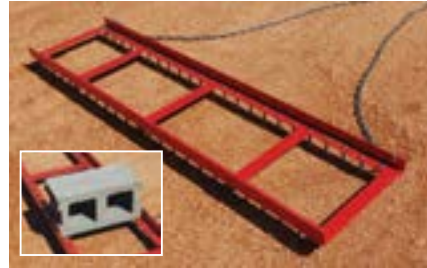

Utilizes 46 staggered heavy grade bolts for heavy dragging. Includes pull chain that can be adjusted by moving to other pre-drilled holes. Additional weight can be added with cement blocks (not included).

- Size:** 6' x 17"
- Steel Bolt Drag **BDRAGDR**
- Replacement Bolts **BDBOLTS**
(Set of 46)

FINISHER MAT

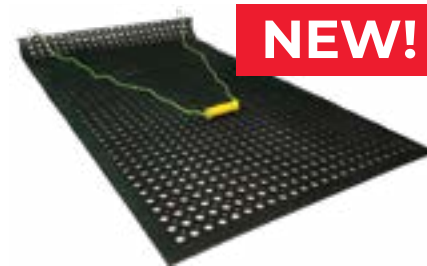

All rubber 'finisher' drag mat provides a great alternative to steel drag mats or to use in conjunction with your steel drag for a smooth surface. Quick drag down your base paths. Mat includes steel front drag bar and tow rope with handle. Easily rolls for transport and storage.

- 3'x5' Finisher Mat **FINMAT35**
- 5'x3' Finisher Mat **FINMAT53**
- 6'x3' Finisher Mat **FINMAT63**
- 6'x6' Finisher Mat **FINMAT66**

6' WIDE LEVELING BAR



Cuts out high spots and allows attached drag mat to redistribute and level infield playing surface.

- 6' Wide Leveling Bar **BLVLBAR**

COCOA DRAG MATS



Features a 1" thick natural fiber surface with a heavy duty rubber backing. Perfect for smoothing out the playing surface after a heavy drag or between innings. Includes drag bar and pull rope with plastic handle. Drag bar can be moved to either side of mat to prolong use. Holes are self-drilled to allow for preferred placement of drag bar.

- 4'W x 2'L Cocoa Drag Mat **BCMAT42**
- 6'W x 2'L Cocoa Drag Mat **BCMAT62**
- 6'W x 4'L Cocoa Drag Mat **BCMAT64**
- 9' Drag Chain **CHAIN**

DRY LINE MARKERS

PROCAGE™ 100 LB CAPACITY DRY LINE MARKER



- Galvanized steel with green powder-coated finish.
- Galvanized steel axle and dispensing wheel.
- White guide strip on lid for proper alignment.
- 4 Heavy-duty no-flat turf tires.
- Hand lever is adjustable for 2" or 4" chalk lines.

100 Lb. Capacity Dry Line Marker (Pneumatic Tires) **BDLM100**

PROCAGE™ 35 LB CAPACITY DRY LINE MARKER



- Galvanized steel with green powder-coated finish.
- Galvanized steel axle and dispensing wheel.
- White guide strip on lid for proper alignment.
- 2 Heavy-duty hard wheels.
- Hand lever is adjustable for 2" or 4" chalk lines.

35 Lb. Capacity Dry Line Marker (Pneumatic Tires) **BDLM35**

PROCAGE™ 50 LB CAPACITY DRY LINE MARKER



- Galvanized steel with green powder-coated finish.
- Galvanized steel axle and dispensing wheel.
- White guide strip on lid for proper alignment.
- Available with heavy-duty no-flat turf tires or heavy-duty hard wheels.
- Hand lever is adjustable for 2" or 4" chalk lines.

50 Lb. Capacity Dry Line Marker (Pneumatic Tires) **BDLM50P**

50 Lb. Capacity Dry Line Marker (Hard Wheels) **BDLM50**

FOLDABLE BATTER'S BOX TEMPLATE



This aluminum template has a light-weight design that is foldable for easy transport & storage. Simply align handle with home plate & press down on template to leave 2" pattern for chalking.

- 4'x6' Foldable Template **BFTMP46**
- 3'x6' Foldable Template **BFTMP36**
- 3'x7' Foldable Template **BFTMP37**



BATTER'S BOX TEMPLATE



Heavy-duty 1" square galvanized steel construction features a home plate guide for easy alignment. Available in 4'x6' (baseball), 3'x7' (softball) and 3-way adjustable (4'x6', 3'x6', 3'x7').

- 4'x6' Baseball Template **BTMPL46**
- 3'x7' Softball Template **BTMPL37**
- 3-Way Adjustable Template **BTMPLA**



FOR CHALK, SEE PAGE 28

FIELD MARKING

ATHLETIC FIELD STRIPERS



Fold-up handle. Features four large heavy-duty wheels. Adjustable 2"-4" stripe. Has storage for 12 extra cans of paint. Ideal for grass and dirt fields.

Standard Model (right):

- Four heavy-duty 10" wheels

NEW Deluxe Model (left):

- Four large pneumatic style no-flat wheels

Athletic Field Striper

BLMSTRIPE

Deluxe Athletic Field Striper

BLINERX

AEROSOL FIELD PAINT



Fast-drying, water resistant. Universal tip fits most machines. 12 (20oz.) cans per case. Available in white, red, yellow, purple, royal, navy, black, orange, maroon, turf green, brown, silver, pink & gold.

White Aerosol Field Paint

LINEW

Color Aerosol Field Paint

LINEC

STRING WINDERS



String line retrieval and storage device complete with 500' of #36 heavy nylon string. Winder makes field lining a breeze & ensures straight lines!

Deluxe Model Features:

- String line retrieval
- Storage device
- 500' of #36 heavy nylon string
- Handle
- Two stakes
- Stand

Standard String Winder

BSTRING

Deluxe String Winder

BDSTRING

MARKSMART FOOTBALL FIELD LAYOUT SYSTEM



Include 50 locators, starting tool and 600' roll of cord. Additional markers available in 6 and 10-piece sets can be used to locate inbound lines, coaches' boxes and more.

Football Field Layout System

MKFLP50

MARKSMART LACROSSE FIELD LAYOUT SYSTEM

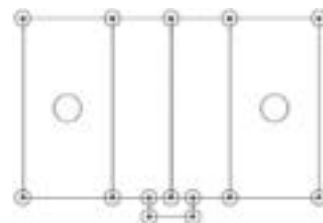

Includes 14 sockets, starter tool and 600' of cord.

Baseball/Softball Field Layout System

MKLLP14

MARKSMART SOCCER FIELD LAYOUT SYSTEM

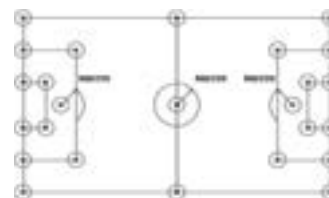

Includes 25 locators, starting tool and 600' cord.

Soccer Field Layout System

MKSLP25

MARKSMART BASEBALL FIELD LAYOUT SYSTEM



Includes 6 sockets, white plugs and 600' of cord.

Baseball/Softball Field Layout System

MKBLP6



GROUND SOCKET WITH PLUG

Ground Socket w/ Plug (1) - Choose white or yellow plug

MKA101

GROUND SOCKET PLUGS - 12 PACK



Ground Sockets - 12 Pack (White or Yellow)

MKA103

10 PACK LINING PEGS



10 Pack Lining Pegs

MKA104

IRRIGATION

1" FIELD HOSES



Featuring outstanding durability and performance, Trigon's field hose series offers a wide selection of precision engineered and manufactured hoses. Made from reinforced rubber and synthetic yarns, these hoses provide a variety based on your application and budget.

- | | |
|-------------------|----------------|
| 100' Hose - GREEN | BPFH100 |
| 50' Hose - GREEN | BPFH50 |
| 100' Hose - CLEAR | BCFH100 |
| 50' Hose - CLEAR | BCFH50 |
| 50' Hose - RED | BRFH50 |
| 75' Hose - RED | BRFH75 |
| 100' Hose - RED | BRFH100 |
| 150' Hose - RED | BRFH150 |



DIAMOND PUMP

Great for removing water from any playing surface. Unit pumps 20 gallons per minute and prevents debris from being drawn in. Additional hose sections & replacement parts are available.

Diamond Pump **BDPUMP**

HEAVY DUTY HOSE CARTS



Designed for the Sports Turf Professional. Maximum durability, no flat tires, great leverage to make it easy to bring a hose on and off a field with ease! Shown with optional tool box.

FEATURES:

- Holds Over 100 Feet of 1" Hose or 125 Feet of 3/4" Hose
- Heavy Duty Hand Truck Frame Easily Maneuvers Hose On and Off the Field
- Solid Rubber Wheels Never Go Flat and Heavy Duty Bearings to Ensure Durability
- Quick Coupler Key Holder Keeps Out of the Way and Accessible
- Includes a 10 Foot Ultramax Blue Leader Hose
- Tool Box Available as Optional Add-On
- Available in 1" or 3/4" Hose Versions

Heavy Duty Hose Cart **HOSECART**
Hose Cart Tool Box **HOSEBOX**

PRO SPRAY NOZZLES & COUPLERS

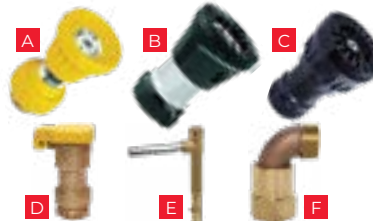

UltraMAX nozzles excel in high demand areas like greens/tees, infield conditioning, and equipment/stadium wash downs. All models offer multi-pattern spray: Fog, Jet Stream, Fan

- | | |
|------------------------------------|------------------|
| A. 3/4" Variable Flow Nozzle | BPNMAG |
| B. UltraMAX 1" Economy Plus Nozzle | BPNUPE |
| C. UltraMAX 1" Premium Nozzle | BPNUPE |
| D. Quick Coupler Valve | BQUICKV |
| E. Quick Coupler Key | BQUICKKEY |
| F. Swivel Elbow | BSWIVELB |

PUDDLE PILLOW

Remove small puddles on your field quickly. Place pillows in standing water and when pillows are saturated, squeeze out absorbed water. Can be reused multiple times! 10 pillows per case. Each pillow can absorb up to 3.5 liters of water.

Puddle Pillow **PILLOW**

SUPER SOPPER



Quickly remove standing water from your playing surface. Can be used on grass, tennis courts or artificial turf. Features an outer foam pad that quickly absorbs water and squeezes it into holding tank.

- | | |
|----------------------------------|-----------------|
| Mackerel Super Sopper (7 Gallon) | MACKEREL |
| Dolphin Super Sopper (14 Gallon) | DOLPHIN |



TURF/GROWTH COVERS



GROWTH COVERS & WINTER TURF BLANKETS

Maintain thicker, greener and healthier grass all year! Made of 3 oz. 100% woven polypropylene, Growth Covers/Winter Turf Blankets, feature a translucent material that allows 90% light to pass through in order to help with optimal grass growth and protection year-round. The border of the covers has a 6-ply, double stitched hem with brass grommets spaced 5' apart.

Includes sod staples. 9" safety yellow stakes available and sold separately

As a winter turf blanket:

- Provides turf protection from harsh winter conditions.
- Shields your turf from wind, ice, snow, and frost.
- Also prevents unwanted foot and animal traffic.

As a growth cover:

- Promotes faster growth and green-up in the spring.
- Retains heat and moisture to naturally warm the soil and air temperature.
- Allows sunlight to pass through the cover.

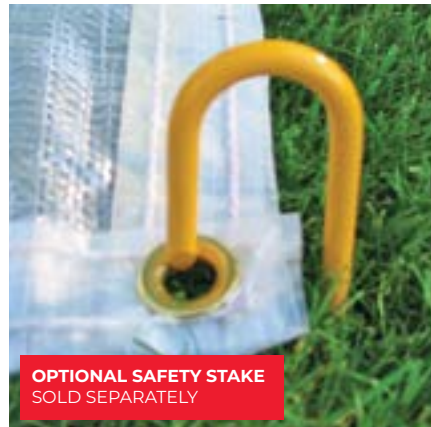

OPTIONAL SAFETY STAKE
SOLD SEPARATELY

- 10'x50' Turf/Growth Cover
- 12'x50' Turf/Growth Cover
- 24'x50' Turf/Growth Cover
- 30'x50' Turf/Growth Cover
- 36'x50' Turf/Growth Cover
- 50'x50' Turf/Growth Cover
- 50'x60' Turf/Growth Cover
- 60'x60' Turf/Growth Cover
- 60'x66' Turf/Growth Cover
- 60'x75' Turf/Growth Cover
- 80'x105' Turf/Growth Cover
- 84'x90' Turf/Growth Cover
- 84'x110' Turf/Growth Cover
- 90'x90' Turf/Growth Cover
- 110'x110' Turf/Growth Cover
- Optional 9" Safety Stake

- GC1050**
- GC1250**
- GC2450**
- GC3050**
- GC3650**
- GC5050**
- GC5060**
- GC6060**
- GC6066**
- GC6075**
- GC80105**
- GC8490**
- GC84110**
- GC9090**
- GC110110**
- GCSTY9**

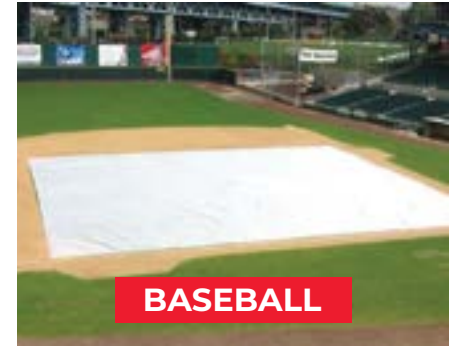

BASEBALL



FOOTBALL



SOCCER

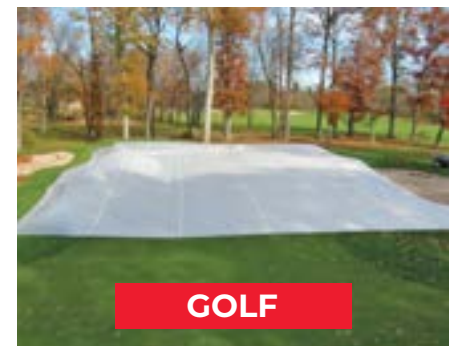

GOLF

BASEBALL/ SOFTBALL

CALL FOR PRICING 888-313-1303

SPOT COVERS

HEAVY-DUTY SPOT COVERS



CUSTOM SIZES & COLORS AVAILABLE

Heavy-duty covers are constructed of a high grade 18 oz. vinyl. Grommets are spaced 3-4' around perimeter. Ground stakes included.

SIZE	DARK GREEN	CUSTOM COLOR
Complete Set - (3) 10'x10', (1) 20', (1) 26'	BHSPOTS	BHSPOTSC
Set of 3 10'x10' Base Covers	BHSPOT10	BHSPOT10C
12' Circular Base Cover	BHSPOT12	BHSPOT12C
18' Circular Mound Cover	BHSPOT18	BHSPOT18C
20' Circular Mound Cover	BHSPOT20	BHSPOT20C
26' Circular Home Plate Cover	BHSPOT26	BHSPOT26C
30' Circular Home Plate Cover	BHSPOT30	BHSPOT30C

Custom Colors: White, Dark Green, Red, Black, Royal Blue, Kelly Green, Grey, Navy Blue, Maroon, Purple, Orange, Yellow & Carolina Blue.



LIGHT-DUTY SPOT COVERS

PRO'S CHOICE



Light-duty covers are constructed of a quality 6 oz. poly. Grommets are spaced 3-4' around perimeter. Ground stakes included.

Complete Set - (3) 10'x10', (1) 20', (1) 26' - 59lbs	BSPOTS
Set of 3 10'x10' Base Covers - 13lbs	BSPOT10
18' Circular Mound Cover - 18lbs	BSPOT18
20' Circular Mound Cover - 22lbs	BSPOT20
26' Circular Home Plate Cover - 24lbs	BSPOT26
30' Circular Home Plate Cover - 30lbs	BSPOT30

WEIGHTED SPOT COVERS



Available in a high-grade 18 oz. vinyl (13 color options) or a 6 oz. poly (Silver/White). Weighted chain sewn-in hems allows for easier rolling and folding. Covers stay in place without stakes or sandbags.

Custom Colors: White, Dark Green, Red, Black, Royal Blue, Kelly Green, Grey, Navy Blue, Maroon, Purple, Orange, Yellow & Carolina Blue.



SIZE	HD 18 OZ VINYL	6 OZ POLY (SILVER/WHITE)
10'x10' Square	BHVYCV10	BLTCV10 (3 PIECE SET)
12' Circular	BHVYCV12	BLTCV12
18' Circular	BHVYCV18	BLTCV18
20' Circular	BHVYCV20	BLTCV20
26' Circular	BHVYCV26	BLTCV26
30' Circular	BHVYCV30	BLTCV30

FIELD COVERS & STORAGE

FULL FIELD COVERS



3-Year Warranty! Made from 7 oz. high-strength, long-lasting, reinforced PVC and polyethylene fabrics. Double-stitched on all four sides with brass grommets placed evenly around the perimeter every 10'. Cover is fabricated in one piece with welded seams. Reinforced corners and web handles located around perimeter. Our Full Field covers are waterproof and rot resistant.

INCLUDES 50 SANDBAGS! CALL FOR CUSTOM QUOTE!

Color: White/Silver

SIZE	PURPOSE	WEIGHT	ITEM#
170' x 170'	Baseball Full Field Cover	1,200 lbs	BTARP170
160' x 160'	Baseball Full Field Cover	1,090 lbs	BTARP160
120' x 120'	Softball Full Field Cover	615 lbs	BTARP120
90' x 90'	Little League Full Field Cover	400 lbs	BTARP90

ACCESSORIES

(12) 9" Heavy-Duty Anchor Stakes	BTARPAS
(20) Poly Sand Bags 14"x25"	BTARPPSB
Vinyl Sand Bag 9"x20"	BTARPVSB
White Roll Repair Tape 3"x60"	BTARPRT

FIELD COVERS INCLUDE 50 SANDBAGS



STORAGE ROLLERS



Heavy-duty 28" double wall corrugated HDPE rollers for storing your full field covers. 34' & 40' rollers come in two pieces for easy assembly on the field with hardware included. **Actual shipping charges apply.**

20' Long (90'x120' covers, 240lbs)	BRLR20
34' Long (160' covers, 400lbs)	BRLR34
40' Long (170' covers, 500lbs)	BRLR40

ECONOMY STORAGE ROLLER COVERS

Economy covers are constructed of heavy field tarp material. Silver/white color only!

20' Economy Roller Cover	BESRCV20
34' Economy Roller Cover	BESRCV34
40' Economy Roller Cover	BESRCV40

HEAVY-DUTY STORAGE ROLLER COVERS

Heavy-duty 18 oz. vinyl cover comes in royal, navy, dark green, black, white, gray, burgundy, brown, yellow, red, or tan. Lettering optional. Custom designs available. Please specify color.



20' Heavy-Duty Roller Cover	BSRCV20
34' Heavy-Duty Roller Cover	BSRCV34
40' Heavy-Duty Roller Cover	BSRCV40
Block-Style Lettering One Color, 14"	BSRCVLTR



FIELD PROTECTORS

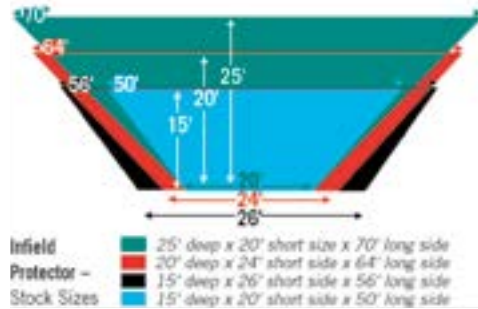
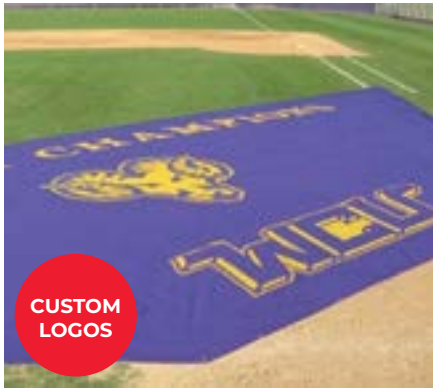

PROMESH INFIELD PROTECTORS

Heavy-duty mesh infield covers protect your natural turf in front of the batting cage and other high-wear areas. Premium mesh is the most durable mesh available! Strong enough to withstand spike cleats!

STANDARD 9OZ MESH

3-YEAR WARRANTY

DIMENSIONS	ITEM#
15'x20'x50'	BVCM50
15'x26'x56'	BVCM60
20'x24'x64'	BVCM64
25'x20'x70'	BVCM70

Available in: Dark Green, Black and Royal Blue.



PREMIUM 14OZ MESH

5-YEAR WARRANTY

DIMENSIONS	ITEM#
15'x20'x50'	BVCP50
15'x26'x56'	BVCP60
20'x24'x64'	BVCP64
25'x20'x70'	BVCP70

Available in: Dark Green, Red, Black, Royal Blue, Kelly Green, Grey, Navy Blue, Maroon, Purple, Orange, Yellow, Carolina Blue & White.



PROMESH TWO-PIECE CAGE COLLAR



Heavy-duty cage collar is made from our ProMesh 14 oz. vinyl poly making it the thickest, longest lasting, most durable material on the market! Perfect for protecting field/home plate areas during batting practice. Will stand up to steel spike traffic. Allows more air & water passage than closed fabrics. Collar will not hold water. Sewn borders with grommets on all sides. Can be customizable with letters & logos.

Size: 20' x 18' x 8' w/ 12' home plate radius.

Available in: Dark Green, Red, Black, Royal Blue, Kelly Green, Grey, Navy Blue, Maroon, Purple, Orange, Yellow & Carolina Blue.



Promesh Two-Piece Cage Collar

BIFMP

IN-GROUND TEMPORARY FENCING



Fencing features a soft, durable mesh fabric with sewn sleeve sections easy installation of poles. Permanent reinforced vinyl pockets spaced every 10' provides ultimate stability. Slide poles into vinyl pockets and drive directly into ground or slide into optional ground sleeves. Poles feature a locking top cap that securely attaches to the top of fencing. Fence poles are black, high gloss PVC, 5' tall. Poles can be rolled up for easy storage. Fence packages include auger and tape measure. All fencing ships truck freight.

STANDARD FENCING



FENCING ONLY	HEIGHT	LENGTH	POLES
BMESH50	48"	50'	0
BMESH100	48"	100'	0
BMESH150	48"	150'	0
FENCE PACKAGE			
BDTEMP50	48"	50'	6
BDTEMP100	48"	100'	11
BDTEMP150	48"	150'	16
HOME RUN FENCE PACKAGE			
BDTEMP200	48"	314'	33
BDTEMP300	48"	471'	49

PREMIUM FENCING



FENCING ONLY	HEIGHT	LENGTH	POLES
BPMESH50	48"	50'	0
BPMESH100	48"	100'	0
BPMESH150	48"	150'	0
PRO FENCE PACKAGE			
BPOF50	48"	50'	6
BPOF100	48"	100'	11
BPOF150	48"	150'	16
HOME RUN FENCE PACKAGE			
BPOF200	48"	314'	33
BPOF300	48"	471'	49

GROUND SLEEVES

Optional ground sleeves are 12" black, high gloss PVC with pointed tips for easy installation. Ground sleeve caps are included when poles are removed. ***GROUND SLEEVES ARE NOT INCLUDED IN FENCE PACKAGES!***

OPTIONAL GROUND SLEEVES

1	BTFGS
6	BTFGS6
11	BTFGS11
16	BTFGS16
33	BTFGS33
49	BTFGS49

INDIVIDUAL COMPONENTS

TempFence Pole	BTPOLE
Reinforced End Pole	BRPOLE
TempFence Ground Sleeve	BTFGS
PVC Driving Tool	BPVCT
12" Auger Bit	BAUG12
Heavy-Duty Rubber Mallet	BMALLET

EASY SET UP & TAKE DOWN!



1. INSERT POLES INTO FENCING.



2. ATTACH FENCE TO TOP CAP.

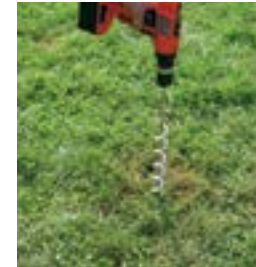

3. MARK & DRILL HOLES



4. PLACE POLES & SOCKETS IN HOLES.



5. ROLL UP FENCING WITH POLES IN PLACE.

ABOVE GROUND TEMPORARY FENCING



Use your portable fencing on synthetic turf, asphalt, concrete, or natural turf. No holes required! Durable, yet soft and easy-to-handle. Quick and easy to set-up and take down. Weighted for each pole to stand up to wind.

STANDARD ABOVE GROUND FENCING

WOVEN LOOPS

ITEM#	HEIGHT	LENGTH	POLES
BDTEMP50AG	48"	50'	6
BDTEMP100AG	48"	100'	11
BDTEMP150AG	48"	150'	16
BDTEMP200AG	48"	314'	33
BDTEMP300AG	48"	471'	49

PREMIUM ABOVE GROUND FENCING

VINYL SLEEVE POCKETS

ITEM#	HEIGHT	LENGTH	POLES
BPOF50AG	48"	50'	6
BPOF100AG	48"	100'	11
BPOF150AG	48"	150'	16
BPOF200AG	48"	314'	33
BPOF300AG	48"	471'	49

INDIVIDUAL COMPONENTS

2' Long Weighted Base Pipe	BTFWP2	Hitch Pin	BTFHP
4' Long Weighted Base Pipe with 4-way Fitting	BTFWP4	C-Clamp	BTFCL

WHICH FENCE KIT DO YOU NEED?

DISTANCE FROM HOME TO CENTER	APPROXIMATE FENCE LENGTH
------------------------------	--------------------------

50'	79'
100'	157'
150'	236'
200'	314'
300'	471'



SOFTBALL & LITTLE LEAGUE

KIT INCLUDES:

- 314' of fencing in one piece in blue, green or red.
- 33 fence poles
- 12" auger
- Tape measure

Standard In-Ground	BDTEMP200
Premium In-Ground	BPOF200
Standard Above Ground	BDTEMP200AG
Premium Above Ground	BPOF200AG

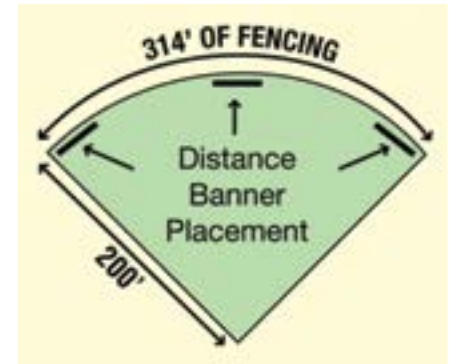

BASEBALL & MEN'S SOFTBALL

KIT INCLUDES:

- 471' of fencing in one piece in blue, green or red.
- 49 fence poles
- 12" auger
- Tape measure

Standard In-Ground	BDTEMP300
Premium In-Ground	BPOF300
Standard Above Ground	BDTEMP300AG
Premium Above Ground	BPOF300AG



SAFETY FENCE CAP

FENCE CROWN/POLY CAP



Protect your players against injury from the top of any chain link fence while you make your ballpark look good. 4^{1/2}" diameter corrugated plastic tubing outlines your ballpark and with our polyester windscreen, gives you that "big league" look. Rolls are pre-slit for easy installation. Ships truck freight. Actual freight charges apply.

Available in: Yellow, Black & Yellow Gold.

- | | |
|-----------------------|-----------------|
| Yellow 250' Roll | BFC250Y |
| Yellow 100' Roll | BFC100Y |
| Gold Yellow 250' Roll | BFC250GY |
| Gold Yellow 100' Roll | BFC100GY |
| Black 250' Roll | BFC250B |
| Black 100' Roll | BFC100B |

SAFETY TOP CAP

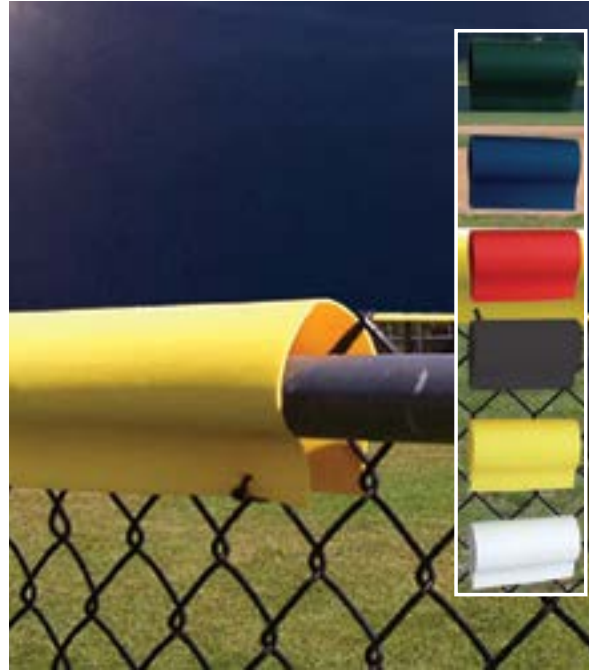

Protects against chain link injuries, increases visibility and adds beauty to any field. Please specify color when ordering. Comes 80 linear feet per box. 10 pieces, 8 feet long with tie wraps included.

15-YEAR WARRANTY

- | | |
|-----------------------|---------------|
| Green Safety Top Cap | BSTCGR |
| Blue Safety Top Cap | BSTCBL |
| Red Safety Top Cap | BSTCRD |
| Yellow Safety Top Cap | BSTCYL |
| White Safety Top Cap | BSTCWH |
| Black Safety Top Cap | BSTCBK |

ATTACHING TOOL



Our Fence Crown Attaching Tool makes installation easy! The installer spreads the fence crown over the fence as you pull.

Attaching Tool

BFCAT

TIE WRAPS



19" Tie Wraps, 100 per pack.

- | | |
|------------------|-----------------|
| Yellow Tie Wraps | BFCTWRPY |
| Green Tie Wraps | BFCTWRPG |
| Black Tie Wraps | BFCTWRPB |

FIELD SCREEN

STANDARD MESH FIELD SCREEN



Windscreens attach to any fence to give you an easy and economical solution to just about any outdoor court or field enclosure need. Used to block wind disturbances, unwanted onlookers or other distractions. It provides an excellent visual background for players, and can also be used to wall off special field sections or unsightly areas.

FEATURES:

- Maximum UV sunlight protection
- Black grommets for a more modern look
- Center lacing lip & wind flaps standard for 9' and taller screens

5' Standard Mesh Screen	BVCM5
6' Standard Mesh Screen	BVCM6
9' Standard Mesh Screen	BVCM9

Available in: Dark Green, Red, Black, Royal Blue, Kelly Green, Grey, Navy Blue, Burgundy, Purple, Orange, Yellow, Carolina Blue, Tan, Brown & White.



FIELD SCREEN LETTERING

Give your fences some style and team spirit with a customized field screen. Even some simple lettering can improve the look of your team's field or stadium. Available in: White, Black, Yellow, Athletic Gold, Royal Blue or Red letters and/or numbers

CALL FOR PRICING ON CUSTOM PRINTED LOGOS!

14" Block Style	BVCM14	36" Block Style	BVCM36
24" Block Style	BVCM24	42" Block Style	BVCM42
30" Block Style	BVCM30		

No returns accepted on custom field screen

WARRANTY:
All field screens and windscreens are fully warranted against fabric & manufacturing defects. 3-year pro-rated warranty against breakdown from UV sunlight.

PROMESH FIELD SCREEN



Made from 14 oz. vinyl coated polyester making it the thickest, longest lasting, most durable windscreen available! Pro Mesh windscreens are so durable we are offering a 5-Year limited warranty! All pieces are custom cut to your specific dimensions and come standard with grommets spaced every 18". All borders are now Heat-Sealed with 21st century heat sealing technology.

ADVANTAGES OF HEAT-SEALING:

- No possibility of thread breaks
- More professional look

5' ProMesh Screen	BPMESH5
6' ProMesh Screen	BPMESH6
9' ProMesh Screen	BPMESH9

Standard heights are 6' and 9'. Please call for pricing on pieces larger than 9' high.

Available in: Dark Green, Red, Black, Royal Blue, Kelly Green, Grey, Navy Blue, Maroon, Purple, Orange, Yellow, Carolina Blue & White.



WINDSCREEN

CLOSED MESH WINDSCREEN

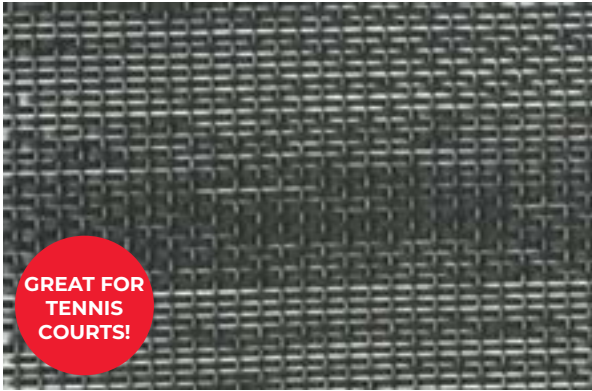

Polypropylene windscreen comes in 6' and 9' heights custom-cut to your specified length. All sides finished with sewn vinyl border and grommets. Provides 95% shade. 9' heights come with center lacing lip.

Colors: Forest Green & Black Only!

- 5' Closed Mesh **PEWC6**
- 9' Closed Mesh **PEWC9**

OPEN MESH WINDSCREEN



Polypropylene Leno windscreen comes in 6' and 9' heights custom-cut to your specified length. All sides finished with sewn vinyl border and grommets. Provides 84% shade. 9' heights come with center lacing lip.

Colors: Forest Green & Black Only!

- 5' Open Mesh **PEW6**
- 9' Open Mesh **PEW9**

ROLLOUT/PRIVACY SCREEN



100% polyethylene engineered to provide site barrier, windbreak, shade, crowd control and privacy. Panels can be attached to chain link fences with plastic wire ties, "S" hooks, or hog rings. Panels can be attached off the roll or can be re-enforced with tape and grommets.

Colors: Green (available in all widths with & without eyelets, 1.25" on center), Beige, Brown, Blue, & Black (available in 5' 8" & 7' 8" widths without eyelets).

- 3' 8" x 50 yds. (no eyelets, specify color) **PPV38**
- 5' 8" x 50 yds. (no eyelets, specify color) **PPV58**
- 7' 8" x 50 yds. (no eyelets, specify color) **PPV78**
- 4' x 50 yds. (with eyelets) - GREEN ONLY **PPV4**
- 6' x 50 yds. (with eyelets) - GREEN ONLY **PPV6**
- 8' x 50 yds. (with eyelets) - GREEN ONLY **PPV8**



FIELD SCREEN ACCESSORIES

- 8" Black Cable Ties (100/bag) **BVCMTIE**
- Black Poly Tie Rope (250') **BKROPE**
- 6" x 12" Boxed Cutout **BVCMBC**
- 18" Diameter Half Moon Vents **BVCMHMV**



CALL FOR PRICING 888-313-1303

RAIL PADDING

SAFEFOAM PADDING



Add padding onto any pole or rail 2" or less in diameter, as well as across your chain link fence tops. Padding is 3/4" with an extra-durable toughskin coating. Sold in 8' lengths, pre-split for easy installation. Ships truck freight.

Specify Color when ordering: (YE) Yellow, (GR) Green, (RB) Royal Blue, (NB) Navy Blue, (RD) Red, (BL) Black, (PU) Purple, (GY) Grey or (SB) Sky Blue.



Safefoam Padding
19" Tie Wraps (100 pack)

BSFPAD
BFC100

PREMIUM ROUND RAIL PADDING



- Fits up to 2 1/2" diameter pipe
- Rail & Pole Pads can be customized for any diameter pole
- Priced per liner foot for all.

Available in: Forest Green, Red, Black, Royal Blue, Kelly Green, Grey, Navy Blue, Burgundy, Purple, Orange, Yellow, Carolina Blue, Tan & White.



1" Thick Premium Round Rail Padding
2" Thick Premium Round Rail Padding

BRLPAD1

BRLPAD2

2-SIDED PREMIUM SQUARE RAIL PADDING



- 2 sided pad protects top rail & front side of dugout
- 2" foam, 18oz vinyl, backed with 3/4" wood backed board
- 6 3/4" top pad depth, 8 3/4" front height
- Can be printed with full color lettering & logos
- Hardware not included.
- Priced per linear foot.

Available in: Forest Green, Red, Black, Royal Blue, Kelly Green, Grey, Navy Blue, Burgundy, Purple, Orange, Yellow, Carolina Blue, Tan, & White.



1" Thick Premium Square Rail Padding
2" Thick Premium Square Rail Padding

BSQRLPAD1

BSQRLPAD2

PREMIUM SQUARE 3 SIDED RAIL PADDING



- 3 sided pad protects top rail and both sides of dugout
- 2" foam, 18oz vinyl, backed with 3/4" wood backed.
- 5 1/2" top pad depth, 6 3/4" front height
- Can be printed with full color lettering & logos
- Hardware not included
- Priced per linear foot for all.

Available in: Forest Green, Red, Black, Royal Blue, Kelly Green, Grey, Navy Blue, Burgundy, Purple, Orange, Yellow, Carolina Blue, Tan, & White.



Premium Square 3-Sided Rail Padding

BRLPADSQ3

BACKSTOP/WALL PADDING



LAUSANNE COLLEGIATE SCHOOL - MEMPHIS, TENNESSEE

PREMIUM FOLDING BACKSTOP PADDING

Made of 18oz. vinyl covers with 2" polyfoam filling. Pads are made to fold in 2' wide panels for easy storage and shipping. Grommets are placed along the top, bottom, and sides for anchoring. Please allow 3-4 weeks for delivery. Please specify color when ordering! Ships truck freight.

Available in: Forest Green, Red, Black, Royal Blue, Kelly Green, Grey, Navy Blue, Burgundy, Purple, Orange, Yellow, Carolina Blue, Tan, Brown & White.



SIZE	ITEM #	PAD W/ GRAPHICS
2'H X 6'L	BSPAD26	BSPAD26L
2'H X 8'L	BSPAD28	BSPAD28L
2'H X 10'L	BSPAD210	BSPAD210L
2'H X 12'L	BSPAD212	BSPAD212L
3'H X 6'L	BSPAD36	BSPAD36L
3'H X 8'L	BSPAD38	BSPAD38L
3'H X 10'L	BSPAD310	BSPAD310L
3'H X 12'L	BSPAD312	BSPAD312L
4'H X 6'L	BSPAD46	BSPAD46L
4'H X 8'L	BSPAD48	BSPAD48L
4'H X 10'L	BSPAD410	BSPAD410L
4'H X 12'L	BSPAD412	BSPAD412L

CUSTOM STADIUM PADDING

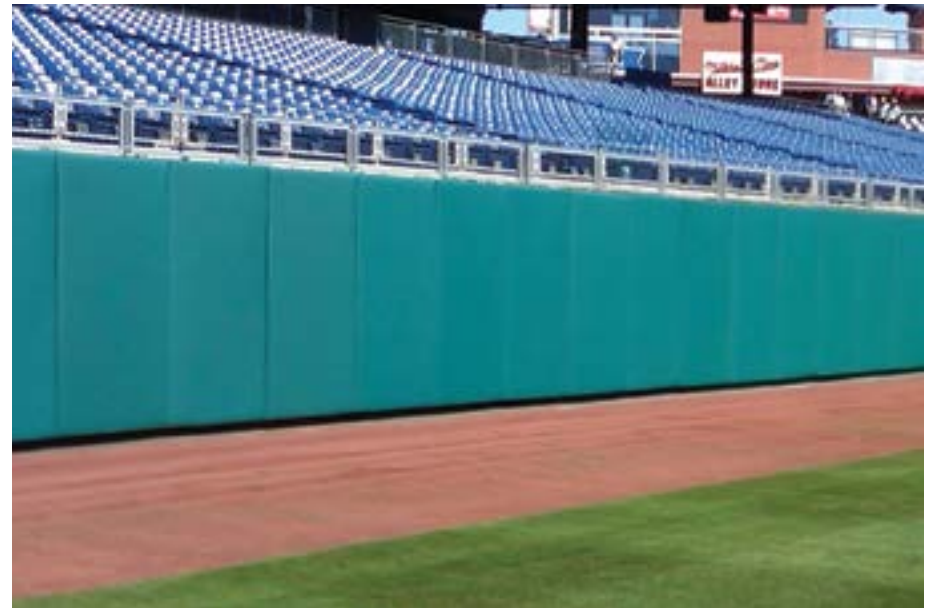

Our custom wood backed stadium padding features 18oz coated vinyl with high UV rating. All pads manufactured with 3/4" exterior grade water sealed plywood backing and bottom grommet weep holes to allow moisture to drain. Options include 2", 3", or 4" Soft IFD 100 foam. Priced per linear foot.

Available in: Forest Green, Red, Black, Royal Blue, Kelly Green, Grey, Navy Blue, Burgundy, Purple, Orange, Yellow, Carolina Blue, Tan, Brown & White.



FOAM	ITEM #	PAD W/ GRAPHICS
2" Soft IFD 100	BWPAD2	BWPAD2L
3" Soft IFD 100	BWPAD3	BWPAD3L
4" Soft IFD 100	BWPAD4	BWPAD4L

ALUMINUM "Z" MOUNTING CHANNELS

Aluminum Mounting channels with 'Z' clips for easy installation. Priced per linear foot.

Aluminum "Z" Mounting Channels **BWPADZC**



CALL FOR PRICING 888-313-1303

FACILITY SOLUTIONS



GYM WALL PADDING

Our indoor wall padding features 18 oz. tough PVC vinyl cover, 2-inch foam cushioning and a 7/16" wood backer board. Call for pricing on custom sizes.

Available in: Forest Green, Royal Blue, Red, Navy Blue, Gray, Burgundy, Light Blue, Purple, Yellow, White, Tan, Black, Orange & Kelly Green.



SIZE	2" MEDIUM FIRM FOAM	2" MEDIUM FIRM FOAM W/ GRAPHICS
2'W x 5'H	IWP25F	IWP25FG
2'W x 6'H	IWP26F	IWP26FG
2'W x 7'H	IWP27F	IWP27FG

INDOOR WALL PADDING



PREMIUM FOLDING BACKSTOP PADDING

Made of 18oz. vinyl covers with 2" polyfoam filling. Pads are made to fold in 2' wide panels for easy storage and shipping. Grommets are placed along the top, bottom, and sides for anchoring. Please allow 3-4 weeks for delivery. Please specify color when ordering! Ships truck freight.

Available in: Forest Green, Red, Black, Royal Blue, Kelly Green, Grey, Navy Blue, Burgundy, Purple, Orange, Yellow, Carolina Blue, Tan, Brown & White.



SIZE	ITEM #	PAD W/ GRAPHICS
2'H X 6'L	BSPAD26	BSPAD26L
2'H X 8'L	BSPAD28	BSPAD28L
2'H X 10'L	BSPAD210	BSPAD210L
2'H X 12'L	BSPAD212	BSPAD212L
3'H X 6'L	BSPAD36	BSPAD36L
3'H X 8'L	BSPAD38	BSPAD38L
3'H X 10'L	BSPAD310	BSPAD310L
3'H X 12'L	BSPAD312	BSPAD312L
4'H X 6'L	BSPAD46	BSPAD46L
4'H X 8'L	BSPAD48	BSPAD48L
4'H X 10'L	BSPAD410	BSPAD410L
4'H X 12'L	BSPAD412	BSPAD412L

GYM FLOOR COVERS



Ultra protection for your gym floor! Covers are constructed in 10' wide sections for easy handling.

STANDARD FEATURES:

- Ultra-durable, flame-retardant, 3-ply fabrics with PVC on both sides, so you can use either side.
- Extra-strength seams made to lay smooth & flat.
- Exceeds ADA & OSHA specs for slip-resistant surfaces.
- 15 different colors options in 18, 22, or 27 oz material!
- 8-15 year limited warranty!
- CUSTOMIZABLE WITH SCHOOL NAME, LOGO, SPONSOR & MORE!
- Rack sold separately.

*We suggest adding 6"-12" when figuring your size to allow for overlapping of each section. (Example: For a 75' x 110' floor, order 8 sections measuring 10' x 110' each.)

18 oz. Gym Floor Cover	FLRCV18
22 oz. Gym Floor Cover	FLRCV22
27 oz. Gym Floor Cover	FLRCV27

SAFETY MOBILE STORAGE RACK



Our Safety Mobile Rack is a great time & back saver.

FEATURES:

- 8" diameter non-marking urethane swivel-type wheels for easy mobility
- Can support up to 2,800 lbs. of fabric
- Can hold 10'-wide sections of almost any length
- Available in 6', 8' & 10' roller models
- 2 hand cranks (easy winding)
- 3 fabric clips (secure winding) per roller
- Safety Collars
- Safety Brakes



6-Roller Storage Rack
8-Roller Storage Rack
10-Roller Storage Rack
Power Winder



CVRACK6
CVRACK8
CVRACK10
CVRACKW



SCOREBOARDS

BATTERY-POWERED SCOREBOARD WITH BLUETOOTH



Battery-operated scoreboard with rechargeable battery all the functionalities of the #SCORE2. Features an exterior shot clock with Bluetooth connectivity for remote operation through its own app. **SHOT CLOCK SOLD SEPARATELY!**

- User-Friendly Operation - Plug & Play, easy to use.
- Clock & Alarm - Can be used as a digital clock with alarm functionality.
- Rugged construction, built-in handle, Optional stand available.
- Multi-Sport Functionality

Shot Clock (Set of 2)

SHCLK3

Shot Clock Stand

SHCLKSTND

Battery-Powered Scoreboard with Bluetooth

SCORE3

BATTERY-POWERED PORTABLE SCOREBOARD



Battery-operated scoreboard with rechargeable battery. Up to 6 hours of battery life when fully charged. Can also be plugged in with included cord. Features all the same timer and game functions as our item #SCORE.

Battery-Powered Portable Scoreboard **SCORE2**
Replacement Remote **SBRMT**

SCOREBOARD STAND

Powder-coated frame with heavy-duty casters for easy mobility. Stand raises timer to 4' high.

SCORE3 Scoreboard Stand Standard **SBSTND3**
Scoreboard Stand **SBSTAND**

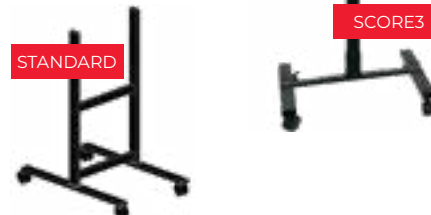

ELECTRONIC PORTABLE SCOREBOARD



Features three-color display and eight (8) different program options. Basketball feature includes shot clock, period, bonus and foul indicators. Built-in carry handle with 15' power cord. Alarm/buzzer volume is adjustable from low to high.

Electronic Portable Scoreboard **SCORE**
Replacement Remote **SBRMT**

POSSESSION ARROW



Bright LED display features indicator lights on the top for fans, coaches and scorekeepers to easily view. Power cord included. Size: 21" x 6" x 3".

Possession Arrow **SBPARR**

SCOREBOARD CARRYING CASE



Nylon bag with adjustable carrying straps. Rear pocket for power cord and owner's manual. Size: 24"L x 10"D x 16"H.

Scoreboard Carrying Case **SBTBAG**

HEAVY-DUTY SECURE BALL LOCKER

PRO'S CHOICE

BEST SELLER!



Full-size HD secure locker holds 28-30 balls. Constructed of heavy duty 1" Powder-coated square steel tubing. Lockable hinged lid for security. 4 HD swivel caster wheels for easy mobility.

Size: 47"L x 24"W x 38"H.

HD Secure Ball Locker

BLOCKS

DELUXE BALL LOCKER



Full size locker holds 28-30 balls. Heavy steel wire mesh. Powder-coated for durability. Hinged lid can be locked. 4 HD swivel caster wheels.

Size: 42"L x 24"W x 38.5"H

HD Secure Ball Locker

BLOCK

3-TIER HEAVY-DUTY BALL CART

PRO'S CHOICE



Holds 15 basketballs. Strong 1" square steel tubing powder coated black for maximum protection. Includes 4 HD swivel, locking caster wheels.

Size: 49"L x 16"W x 35"H.

3-Tier HD Ball Cart

CART315

2-TIER HEAVY-DUTY BALL CART



Holds 15 basketballs. 2-tier system for better strength and stability. Powder-coated black with 4 HD swivel caster wheels.

Size: 51"L x 19"W x 38"H

2-Tier HD Ball Cart

CART215

DOUBLE-WIDE BALL CART



Holds 30 basketballs. Strong 1" square steel tubing powder coated black for maximum protection. Includes 4 HD swivel, locking caster wheels.

Size: 52"L x 25"W x 35" H.

3-Tier Double-Wide Ball Cart

CART330

BIG BALLER PRO BALL CART



NEW!

Angled design to allow for balls to roll to ends of cart. HD round tubing powder coated black for maximum protection. Holds 15 balls.

Size: 49"L x 16"W x 35"H.

Big Baller Pro Ball Cart

BIGBALLER15

CALL FOR PRICING 888-313-1303

INDOOR RIMS

BREAKAWAY SINGLE RIM



Front mount 5/8" x 18" single rim with powder coated heavy steel construction. Universal back plate accommodates most fan-shaped and rectangular backboards. For indoor use. Includes net and mounting hardware. 4" x 5" Mounting Pattern.

Breakaway Single Rim **BBRIMBRS**

BREAKAWAY REAR MOUNT RIM



Rear mount 5/8" x 18" single rim with powder coated heavy steel construction. Compatible with rear mount backboards. Includes net and mounting hardware. 4" x 3 7/8" Mounting Pattern.

Breakaway Rear Mount Rim **BBRMBR**

OUTDOOR RIMS

REAR MOUNT RIM



Rear mount 5/8" x 18" single rim with powder coated heavy steel construction. Includes net and mounting hardware. 4" x 3 7/8" Mounting Pattern.

Rear Mount Rim **BBRMS**

HEAVY-DUTY DOUBLE RIM



Heavy-duty playground rim with welded wing plates & 5/8 x 15 braces. Front mount 18" double rings are 3/4" and 1/2". Back plate accommodates 42" or 48" rectangular & fan-shaped backboards. Includes nylon net & mounting hardware. For outdoor use.

Heavy-Duty Double Rim **BBRIMD**

BREAKAWAY DOUBLE RIM

Front mount 5/8" x 18" double rim. Full steel wing brace design powder coated for protection. Back plate accommodates 42" or 48" rectangular & fan-shaped backboards. Includes anti-whip net & mounting hardware. For indoor or outdoor use.

Breakaway Double Rim **BBRIMBR**



HEAVY-DUTY SINGLE RIM

Regulation rim has powder-coated finish & heavy steel bracing for outdoor use. Universal back plate accommodates 42" or 48" rectangular & fan-shaped backboards. Front mount 5/8" x 18" single rim. Includes nylon net & mounting hardware.

Heavy-Duty Single Rim **BBRIMS**



BACKBOARDS

ACRYLIC RECTANGULAR BACKBOARD



42" x 60" backboard made of 3/8" UV-resistant acrylic permanently attached to a 3/4" x 11/2" welded steel tubular support frame. Direct mount design allows for permanent attachment of board to post & easy rim replacement. For indoor or outdoor use. **BACKBOARD, PADDING, RIM & NET SOLD SEPARATELY.**

Acrylic Rectangular Backboard

BBABB

PREMIUM BACKBOARD PADDING



High-density urethane foam with a tough exterior skin. Easy bolt-on design fits all 72" wide glass backboards. Kit includes 2 pieces of padding for one backboard and mounting hardware. For indoor use only.

Available in: Forest Green, Royal, Red, Navy, Gray, Maroon, Purple, Gold, Black, Orange, Kelly Green, Pink, Columbia Blue, Burgundy, and Brown.



Premium Backboard Padding

BBPAD

STEEL RECTANGULAR BACKBOARD

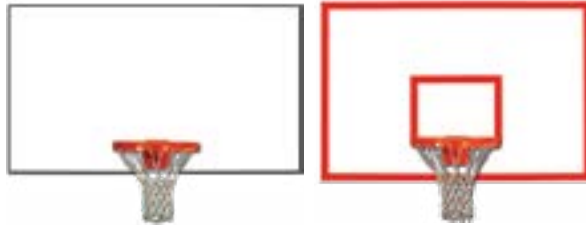

42" x 60" steel backboard with white powder coated finish. Choose from screened target and border or solid white. For indoor or outdoor use. 5" x 5" Mounting Pattern. **RIM & NET SOLD SEPARATELY.**

Steel Backboard with Target & Border
Steel Backboard Solid White

BBSRTB
BBSRW

OUTDOOR BASKETBALL PLAYGROUND SYSTEM



Systems feature an industry standard 4 1/2" O.D. post. Goose-neck packages include post, 4' extension, Aluminum fan-shape backboard with target & border, & a super double ringed rim.

Complete Playground System
(includes BBNECK4 Goose-neck)

BBAL454

4 1/2" O.D. Goose-neck

BBNECK4

Front Mount with Target & Border

BBFTB

Heavy-Duty Double-Rim

BBRIMD

FAN SHAPED STEEL BACKBOARD



35" x 54" HD 12-gauge steel backboard with white powder-coat finish. Reinforced mounting points for reduced vibration. Choose from screened target only or screened target & border. For indoor or outdoor use.

RIM & NET SOLD SEPARATELY.

Front Mount Backboard

BBFT

Front Mount Backboard with Target & Border

BBFTB

Rear Mount Backboard

BBRMW

Rear Mount Backboard with Target

BBRIMD



SPORTS SPEED & AGILITY KIT



KIT INCLUDES:

- Dual Harness (Evasion belt)
- 48" Speed Chute
- Shoulder/Speed Harness
- (2) 6" Hurdles
- (2) 9" Hurdles
- (2) 12" Hurdles
- (2) 5m Speed Ladders
- (12) Saucer Cones
- Leg Toning Tube
- Reaction Ball
- Trigon Sports Carry Bag

Sports Speed & Agility Kit **FPSU42**

SPEED SLED



Improves speed, acceleration & leg strength. Includes powder-coated steel sled & shoulder harness with belt attachment. Add-on weights not included.

Speed Sled **ASLED**

PLYOMETRIC BOXES



Features heavy-duty, powder-coated steel frame. Top surface constructed of 18" square laminated wood covered with a non-slip synthetic surface.

- 12" Plyometric Box
- 18" Plyometric Box
- 24" Plyometric Box
- 30" Plyometric Box
- 36" Plyometric Box

- PLYO12**
- PLYO18**
- PLYO24**
- PLYO30**
- PLYO36**

AGILITY HURDLES



Constructed of heavy-duty PVC. Hurdle can be adjusted from 6" to 12" by twisting the legs in reverse direction. Comes in sets of 4.

Agility Hurdles **AH612**

PRO AGILITY LADDER



The ultimate speed and agility training ladder. Made from 20" wide flat plastic rungs & 27' long nylon tape border. Distance between rungs is fully adjustable. Use narrow spacing on this workout ladder for short and quick steps or wider spacing for longer strides. Comes with carry bag.

Pro Agility Ladder **ALPRO**

SPEED CHUTE



This is the ultimate resistance tool for improving speed, stamina, strength & acceleration. Chute opens while running to provide resistance. Comes with carry bag.

- 40" Speed Chute **ASC40**
- 48" Speed Chute **ASC48**
- 54" Speed Chute **ASC54**

FOOTBALL TRAINING AIDS

FOOTBALL PASSING NET WITH SWIVEL TOP



- Powder coated steel frame
- Catch net is adjustable to 7 different swivel positions
- All-terrain turf tires with locking wheels
- Red center target with red outline to easily identify at long distances

Size: 51"W x 8'H (At tallest setting)

Football Passing Net
With Swivel Top

FBPASS

SIDELINE PRO COLLAPSIBLE KICKING CAGE



Strong yet light weight aluminum collapsible kicking cage. Quick and easy assembly in seconds. The high-grade durable net attaches easily using heavy duty Velcro sewn into the 18 oz vinyl.

Size: 87" tall x 48" wide

Sideline Pro Collapsible
Kicking Cage

FBKSPC

PROFESSIONAL KICKING CAGE



Features a sturdy 2" Powder-Coated Steel Base w/ 15/8" uprights. Net made from Heavy-duty knotless netting. Designed for quick & easy set-up and take down. Comes complete with carry bag.

Size: 48" x 48" x 86" tall.

Professional Kicking Cage
Replacement Net

**FBPROK
FBPROKN**

RUNNING ROPES

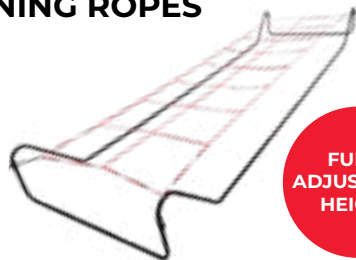

FULLY
ADJUSTABLE
HEIGHT



Designed for building foot speed and agility. 1" Galvanized steel tube frame, powder-coated black with suspended rope running grid. Adjustable height. Designed for quick assembly and safety with tubing frame outside the running grid.

Size: 17' L x 5' W.

Running Ropes
Replacement Ropes

**FBHSTP
FBROPE**



DELUXE HELMET CART



HD steel rack comes with 4" HD swivel-lock wheels. Rack holds 60 football helmets. Size 59"H x 59"L x 24"D allows rack to fit through standard doorway.

Deluxe Helmet Cart

FBHCART

SHOULDER PAD HANGERS

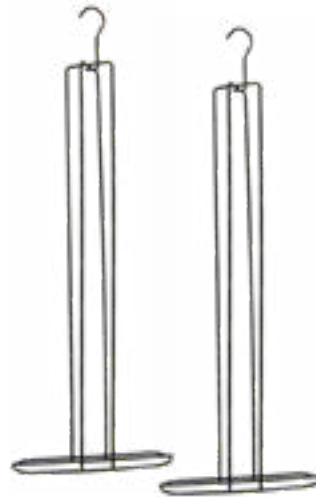

All steel, welded construction powder coated black. Each shoulder pad hangers holds 14 shoulder pads. Sold in sets of 2.

Shoulder Pad Hangers - Set of 2

SPHGR

PRO DELUXE SHOULDER PAD RACK



Holds 60 XXL Pads! Heavy-duty steel bottom frame with retractable pull handle and large locking wheels for easy transport. Steel uprights with bottom position bar allows for neat and orderly stacking.

Pro Deluxe Shoulder Pad Rack

FSPR60

AERIAL ATTACK FOOTBALL MACHINE

The Aerial Attack Football machine is designed for football programs on a tight budget. This unit will deliver right-footed deep spiral punts that turn over as well as end-over-end kickoffs for coverage and return practice. Plus... it throws both long and short passes for receiving and defensive drills. It will pivot in any direction to challenge the defensive coverage or to instantly throw to an exact location.



Aerial Attack Football Machine

FBAAFM

GAMEDAY FIELD LAYOUT

Professional grade 1/16" polyethylene stencils are flexible, allowing them to conform to any smooth or rough surface that needs marking. Get the sharpest, most accurate stencil markings possible. Polyethylene stencils make cleanup quick and easy. When paint dries it simply flakes off. Stencils are backed by a lifetime warranty!

FOOTBALL FIELD STENCIL KITS



STENCIL KITS INCLUDE:

- 1 pc. Characters (# 0-5) (PRO Kit includes 2 pc. characters)
- Directional Arrow

3' Football Marking Kit (1/16")	FMK3D
3' Football Marking Kit (1/8")	FMK3M
6' Football Marking Kit (1/16")	FMK6D
6' Football Marking Kit (1/8")	FMK6M
6' Pro-Style Football Stencil Kit (1/16")	FMKPRO

HASH MARKS STENCIL KITS



STENCIL KITS INCLUDE:

- 4 Hash Marks on One Panel

4"x18" Hash Stencil Kit **FBHASH**

MARKSMART FOOTBALL FIELD LAYOUT SYSTEM



Include 50 locators, starting tool and 600' roll of cord. Additional markers available in 6 and 10-piece sets can be used to locate inbound lines, coaches' boxes and more.

Football Field Layout System **MKFLP50**

CUSTOM FIELD STENCILS AVAILABLE



GAMEDAY FIELD EQUIPMENT

SOLID FOAM WEIGHTED SIDELINE MARKERS



Triangle weighted sideline markers are a 1 piece foldable design. Each set includes 2 pieces each: "G" (Goal) through "40" and one "50" marker.

Available in: Orange/black

Solid Foam Weighted Sideline Markers (Set of 11) **FBST11**

WEIGHTED ANCHORLESS PYLONS



Pylons are one-piece solid foam with weighted bottoms. Sold in sets of 4. Available in Orange.

Football Field Layout System **FBPYLS**

DELUXE DOWN BOX & CHAIN SET

Unbreakable padded down box with Black foam padding. Chain set is 6'10" with orange foam padding and 12" flip-over numbers. Chain set is 7'6" with 15" padded bull's eye with Orange padded banners and poles. Available in Orange/black.



Deluxe Down Box & Chain Set

FBDSL3

Down Box Only
Chain Set Only

FBDB03

FBCS03

AEROSOL FIELD PAINT



Fast-drying, water resistant. Universal tip fits most machines. 12 (20oz.) cans per case. Available in white, red, yellow, purple, royal, navy, black, orange, maroon, turf green, brown, silver, pink & gold.

White Aerosol Field Paint
Color Aerosol Field Paint

LINEW

LINEC

CALL FOR PRICING 888-313-1303

SIDELINE & TRACK PROTECTORS



PROMESH SIDELINE PROTECTOR

Our ProMesh material features heavy-duty 14 oz. mesh that has extreme tear resistance. Tarps are heat-fused for abrasion resistance to spikes and breathable to allow air and water passage. Grommets are spaced at 3' intervals around perimeter. 12 stock colors available. Optional lettering & logo printing available. Ships truck freight.

AVAILABLE COLOR OPTIONS:



STOCK SIZE	ITEM#
12' x 50'	FPM1250
12' x 75'	FPM1275
12' x 100'	FPM12100
12' x 125'	FPM12125
12' x 150'	FPM12150
15' x 50'	FPM1550
15' x 75'	FPM1575
15' x 100'	FPM15100
15' x 125'	FPM15125
15' x 150'	FPM15150

BLANKET-STYLE SIDELINE PROTECTOR



Blanket material features non-woven poly fabric that is heather gray in color to deflect heat. Blanket material is breathable to allow air and water passage. Grommets are spaced at 3' intervals around perimeter.



SIZE	ITEM#
14' x 50'	FST1450
14' x 75'	FST1475
14' x 100'	FST14100
14' x 125'	FST14125
14' x 150'	FST14150

WEIGHTED TRACK PROTECTOR



Premium heavyweight 16 oz. non-woven polypropylene fabric. Heat tempered on both sides for excellent durability to cleat traffic. Light gray color will not absorb heat like dark colors. Features a weighted perimeter with vinyl border that stays in place without the need for stakes or sand bags that could damage track surface. Choose from 14 different border colors!

BORDER COLOR OPTIONS:



SIZE	ITEM#
7' x 30'	WTP730
7' x 40'	WTP740
7' x 50'	WTP750
14' x 30'	WTP1430
14' x 40'	WTP1440
14' x 50'	WTP1450

PROMESH WEIGHTED TRACK PROTECTOR

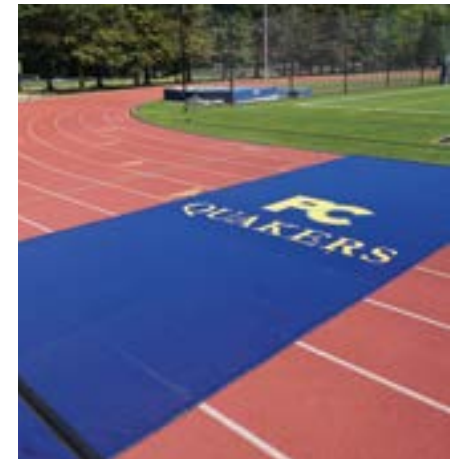

Our ProMesh material features heavy-duty 14 oz. mesh that has extreme tear resistance. Tarps are heat-fused for abrasion resistance to spikes and breathable to allow air and water passage. Features a weighted perimeter with vinyl border that stays in place without the need for stakes or sand bags that could damage track surface. Optional lettering & logo printing available. Ships truck freight.

AVAILABLE COLOR OPTIONS:



SIZE	ITEM#
6' x 30'	PMWTP630
6' x 40'	PMWTP640
6' x 50'	PMWTP650
12' x 30'	PMWTP1230
12' x 40'	PMWTP1240
12' x 50'	PMWTP1250

GOAL POSTS

OFFICIAL FOOTBALL GOAL POSTS



Goose-neck style goalposts are manufactured of heavy Schedule 40 galvanized steel with a 4^{1/2}" OD (5' offset). Goal posts feature 3" O.D. crossbars and 2^{3/8}" O.D. x 20' H aluminum uprights. Fully adjustable in 2 directions for precise alignment. Goals can be permanently installed in concrete footings or set in optional ground sleeves. Available in powder-coated white or yellow with either 23' 4" High School or 18' 6" Collegiate crossbars. Ships truck freight.

COLOR	CROSSBAR	ITEM #
Yellow	18' 6"	FBGP4YC
White	18' 6"	FBGP4WC
Yellow	23' 4"	FBGP4YHS
White	23' 4"	FBGP4WHS
Optional 4.5" ground sleeves		FBGP4GS

GOAL POST NETS

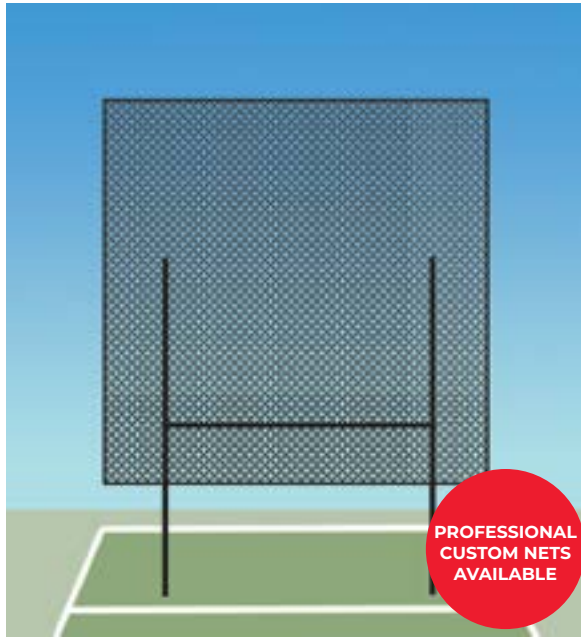

Nets are designed for use behind football goal posts to retrieve kicked balls. Netting is #18 with a 4" square mesh border on all four sides with steel rings in corners for easy hanging. All nets are weather & UV treated to guarantee years of service.

SIZE	ITEM #
30' H x 30' W	FGN3030
30' H x 35' W	FGN3035
35' H x 45' W	FGN3545
40' H x 40' W	FGN4040
40' H x 45' W	FGN4045

GOAL POST PADS

Made from 18 oz. vinyl with 4" urethane foam. Standard height is 6' with hook & loop Velcro or laced-grommet closures. Custom heights & thicknesses available! Ships truck freight. Shown with optional custom print. Call for custom pricing.

Available in: Forest Green, Royal, Red, Navy, Gray, Maroon, Sky Blue, Purple, Yellow, White, Tan, Black, Kelly Green and Orange!

4" Velcro Closure	PPAD4V
4" Laced Closure	PPAD4L
6" Velcro Closure	PPAD6V
6" Laced Closure	PPAD6L



DUMMIES & PADS



STAND-UP DUMMIES

Heavyweight durable vinyl design makes the Stand-Up dummy strong, firm and durable. Available with replaceable bottoms. Great for use of all levels of players.

Color options:



42" x 14" Stand Up Dummy **FPSU42**

48" x 14" Stand Up Dummy **FPSU48**

HALF-ROUND DUMMIES

Dual-purpose for step-over and blocking drills. Handles allow for use as a blocking dummy, while the half-round design gives it versatility for speed & agility drills.

Color options:



42" x 14" x 7" Half Round Dummy **FPHR147**

42" x 16" x 6" Half Round Dummy **FPHR166**



STEP-OVER DUMMIES



Trapezoidal design keeps dummy in place. 18 oz. vinyl coated nylon, double stitched seams and reinforced handle.

Color options:



8" x 18" x 48" x 8" Step-Over Dummy **FPSO8**

12" x 18" x 48" x 8" Step-Over Dummy (Black not available in 12") **FPSO12**

FOREARM PADS



Reinforced vinyl cover with 4" thick Poly-Foam filling, contoured forearm design and elbow protectors. Sold in pairs.

Color options:



Forearm Pads

FPFA4

CURVED BLOCKING DUMMIES



Reinforced vinyl cover comes with either 3" or 5" Poly-Foam filling. Size: 25" x 18".

Color options:



3" Thick Shield Dummy

FPBS3

5" Thick Shield Dummy

FPBS5

MAN SHIELD



Man-shape provides for more realistic drills. Reinforced vinyl covering, 5" thick molded Poly-Foam core retains shape and lasts longer.

Size: 36" T x 31" W.

Color options:



Man Shield

FPMS5

SLP BLOCKING PAD



Blocking Pad that has 2 special features. Feature 1 is the "belt" feature that helps safely drill the Gallop technique with no contact to the head. Feature 2 is the "backpack" feature that teaches athletes how to properly distribute their weight against a moving defender.

SLP Blocking Pad

FSLPBLOCK

LACROSSE GOALS

OFFICIAL LACROSSE GOAL

BEST SELLER!

MEETS NCAA AND NFHS SPECIFICATIONS.



Official size 6'H x 6'W x 7'D features 2" HD orange powder-coated galvanized steel frame. One-piece welded face, mitered corners and lacing rail. 3/8" thick flat steel ground bar for goal stability. Includes 7mm nets and lacing cord. Sold as pairs.

Official Size Lacrosse Goal

LGOFF

DELUXE LACROSSE PRACTICE GOAL



Official size 6'H x 6'W x 7'D features 1.5" powder-coated orange galvanized steel frame. Includes full lacing rail around goal frame and ground supports. Goals include 4mm net and lacing cord. Sold individually.

Deluxe Lacrosse Practice Goal

LGPRACD

LACROSSE PRACTICE GOAL



Official size 6'H x 6'W x 7'D features 1.5" powder-coated orange galvanized steel frame. Net laces around frame face and ground supports. Goals include 4mm nets and lacing cord. Sold individually.

Lacrosse Practice Goal

LGPRAC

SILVERLINE PRACTICE LACROSSE GOAL



1.5" powder-coated orange galvanized steel frame. Net laces around frame face and ground supports. 4mm net and lacing cord.

SOLD INDIVIDUALLY.

Practice Partner® Silverline
Lacrosse Goal

SLVLG

LACROSSE GOAL



Official size lacrosse goal. Formed from 18-gauge, 1.5" powder-coated steel tubing. Includes 3mm, heavy-duty weatherized netting.

Size: 72"W x 72"H x 84"D

Practice Partner®
Lacrosse Goal

LGPRAC

LACROSSE WALL REBOUNDER



Constructed of 1.5" 18-gauge steel tubing with 4' x 3' rebounding surface.

Size: 84"T x 36"W

Practice Partner®
Lacrosse Wall Rebounder

LPBT

LACROSSE NETS

Official size lacrosse nets with choice of heavy-duty 7mm or standard 5mm net. Sold individually.

Lacrosse Net - 5mm

LGNET5

Lacrosse Net - 7mm

LGNET7



LACROSSE GOAL DOLLY



Move any lacrosse goal on and off the field with ease. Slide the front brackets under the front corners of your goal, tilt back on the handle while also holding the top of the goal, then easily move your goal to its desired location. Push-button assembly.

Lacrosse Goal Dolly **LGODO**

MARKSMART LACROSSE FIELD LAYOUT SYSTEM

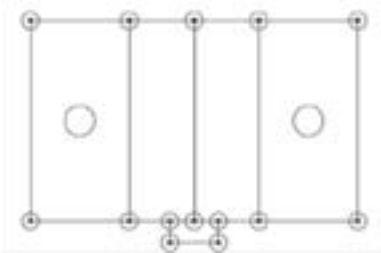

Includes 14 sockets, starter tool and 600' of cord.

Baseball/Softball Field Layout System **MKLLP14**

LACROSSE GOAL TARGET



Great for players of all ages and skill levels, the ProCage™ Lacrosse Goal Target is perfect for improving your shooting precision and accuracy! Black vinyl with seven target zones. Includes fasteners to easily attach to your 6' x 6' goal. Goal and net not included.

Lacrosse Goal Target **LGT66**

30' X 10' MULTI-SPORT BACKSTOP NET

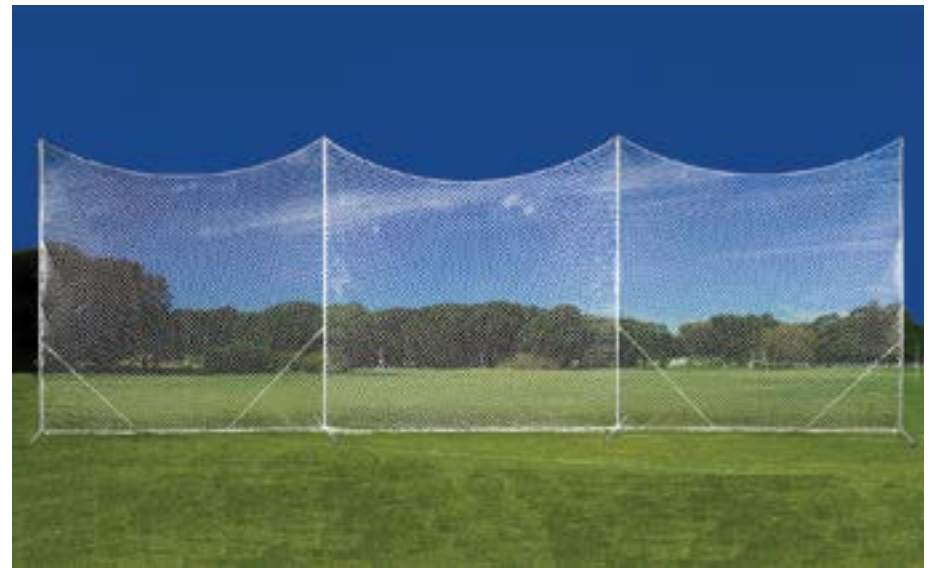

Free-standing backstop is ideal for catching stray balls during your practice sessions or games. Sturdy and durable, the Backstop Net features a 2.5 mm net with 1.25" galvanized steel upright poles. Leg supports provide maximum stability.

30' x 10' Multi-sport Backstop Net **MSBN**

AEROSOL FIELD PAINT



Fast-drying, water resistant. Universal tip fits most machines. 12 (20oz.) cans per case. Available in white, red, yellow, purple, royal, navy, black, orange, maroon, turf green, brown, silver, pink & gold.

White Aerosol Field Paint **LINEW**
Color Aerosol Field Paint **LINEC**

GAMEDAY FIELD EQUIPMENT

SOCCER REBOUNDER 6' X 12'

BEST SELLER!



Large and sturdy 6' x 12' size with powder-coated galvanized steel tube frame. Great for improving shooting strength or accuracy.

Included Accessories:

- 3' stabilizing legs for added stability
- UV treated net
- Bungee cords for attachment.

Soccer Rebounder 6' x 12'
Soccer Rebounder Replacement Net

SR612
SR612N

MARKSMART SOCCER FIELD LAYOUT SYSTEM

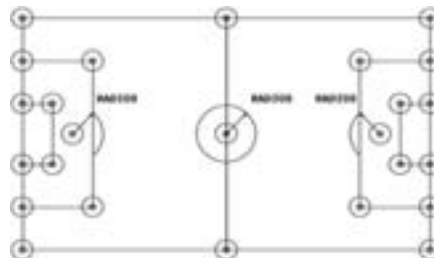

Quickly mark any size soccer field. Includes 25 locators, starting tool and 600' cord.

Soccer Field Layout System **SLS25**

SOCCER REFEREE FLAG



Set of 2 soccer linesman flags with a storage bag. Flags include padded handles, fluorescent red and yellow flags with heavy-duty PVC shaft.

Soccer Referee Flag **SREFLAG**

SOCCER NETS



All nets come in white or orange with 5" square mesh and meet NCAA, NHSAA and FIFA specifications.

THREAD	SIZE	ITEM #
4mm	8' x 24' x 4' x 10"	SN4824
3mm	8' x 24' x 4' x 10"	SN3824
3mm	7' x 21' x 3' x 8'	SN3721
3mm	6.5' x 18' x 3' x 7'	SN3618

DELUXE CORNER FLAG SET



1" OD x 60"H flexible PVC upright attached to official red flag. Spring-loaded steel base for easy ground insertion. Set of 4.

Deluxe Corner Flag Set **SCFLAGD**

CORNER FLAG SET CARRY BAG



Features a reinforced vinyl bottom to help prevent spikes from coming through. Holds up to four corner flags.

Corner Flag Set Carry Bag **SCFBAG**

SOCCER GOALS

PVC PORTABLE SOCCER GOAL W/NET



Perfect for all levels of play. Ultra-tough and durable molded PVC soccer goal comes in two sizes, 3' high x 4' wide or 4' high x 6' wide. Push-button assembly makes for quick and easy setup and take down. Lightweight and sturdy for easy transport. **ALL GOALS SOLD INDIVIDUALLY.**

EACH GOAL INCLUDES:

- PVC Crossbar & Uprights
- Red Net
- PVC Backstays
- 25 Net Clips
- U-Type Anchor stakes
- Carry Bag

3 x 4' Portable PVC Soccer Goal	SGP34
4 x 6' Portable PVC Soccer Goal	SGP46

RECREATIONAL SOCCER GOALS



4" x 2" Recreational Soccer Goals are a popular choice for clubs, camps, practice sessions, and recreational use. Goals meet NCAA, NHSAA, and FIFA specifications. Optional wheel adapter kit available for easy transport.

ALL GOALS INCLUDE NETS.

EACH GOAL INCLUDES:

- Crossbar & Uprights
- One-Piece Ground Bar
- Backstays
- Net Clips
- (4) 14" HD Steel Ground Anchors
- Net

8' x 24' Recreational Soccer Goal	SGC824
7' x 21' Recreational Soccer Goal	SGC721
6' x 18' Recreational Soccer Goal	SGC618

OFFICIAL ALUMINUM SOCCER GOALS



Aluminum soccer goals come in 4" round or square options. Goal is official 8' x 24' size and meets NCAA, NHSAA, and FIFA specifications. Features extruded aluminum frame that is light-weight & easy to transport and rounded corners for safer play. One-piece welded goal frames. Crossbar & uprights include a net channel for easy net attachment with included net clips. Heavy-duty backstays are 1⁵/₈" galvanized steel. Optional ground anchors recommended to decrease risk of goal tipping over. **ALL GOALS INCLUDE 4MM NETS.**

EACH GOAL INCLUDES:

- Backstays
- Crossbar & Uprights
- 8' x 24' Net
- Net Clips
- One-Piece Ground Bar
- (4) 14" HD Steel Ground Anchors

8' x 24' Round Aluminum Soccer Goal	SG824RD
8' x 24' Square Aluminum Soccer Goal	SG824SQ
Ground Anchors	SGANCH
Soccer Goal Wheel Kit	SGWK

PORTABLE ALUMINUM CLUB SOCCER GOAL



3" Aluminum club soccer goals available in sizes for all levels of play. 3" round aluminum front face with double reinforced corners, available in powder coated white or natural aluminum, also feature a built in net clip track for easy net installation. Galvanized steel 1.66" OD backstays for added stability. All goals include a 3mm white net and "J" Stake anchors for added safety and stability. Underground or Auger style anchors available at an additional cost. **SOLD IN PAIRS.**

EACH GOAL INCLUDES:

- Crossbar & Uprights
- "J" Stake anchors
- Hardware
- 3mm white net
- Built-in net clip track
- Net clips

U6 4' x 6' Portable Soccer Goal w/ Net	SG3046W
U8 6' x 12' Portable Soccer Goal w/ Net - White Finish	SG3612W
U8 6' x 18' Portable Soccer Goal w/ Net - White Finish	SG3618W
U12 7' x 21' Portable Soccer Goal w/ Net - White Finish	SG3721W
U12 8' x 24' Portable Soccer Goal w/ Net - White Finish	SG3824W

SILVERLINE SOCCER GOALS



Silverline soccer goal series comes in two sizes: 9'W x 6'H x 4'D and 12'W x 6'H x 4'D. Goals are great for all levels and ages of soccer. Goals are constructed of a 15/8" diameter, 18-gauge steel tubing. Includes a professional quality, heavy-duty weatherized net.

- Practice Partner® Silverline Soccer Goal 6x9 **SLVSG9**
- Practice Partner® Silverline Soccer Goal 6x12 **SLVSG12**
- Practice Partner® 6'x9' Replacement Soccer Net **SOCNET9**
- Practice Partner® 6'x12' Replacement Soccer Net **SOCNET12**

SOCCER NETS



All nets come in white or orange with 5" square mesh and meet NCAA, NHSA and FIFA specifications.

THREAD	SIZE	ITEM #
4mm	8' x 24' x 4' x 10"	SN4824
3mm	8' x 24' x 4' x 10"	SN3824
3mm	7' x 21' x 3' x 8'	SN3721
3mm	6.5' x 18' x 3' x 7'	SN3618

4' X 8' FOLDING SOCCER GOAL



Foldable goal features push-button assembly and all-weather net. Perfect portable goal for practice.

Size: 4'H x 6'W x 3'D

- Practice Partner® Folding Soccer Goal **FOLD95**

6X9 SOCCER REBOUNDER



Assembles to 6'H x 9'W. Precision-fit locking pins for easy assembly. Constructed of 1.5", 18-gauge heavy-duty steel tubing.

- Practice Partner® Soccer Rebounder **SOCREB**

PRO DELUXE HOCKEY GOAL



The Practice Partner 72-in Pro Deluxe Hockey Goal helps the scoring-minded players and goaltenders perfect their skills! The goal's durable frame is made of 2-in galvanized steel tubing with weather treated red powder coating. The double welded net attachment system keeps the net squarely fastened together, perfect for indoor and outdoor use.

Practice Partner® Hockey Goal

RHX2

SILVERLINE HOCKEY GOAL



The Practice Partner 72-in Silverline Pro Style hockey goal matches a strong, power-coated steel tubing frame with heavy-duty weatherized netting. It features a securely welded net attachment system and a Pro-Style rounded back.

Practice Partner® Silverline Hockey Goal

SLVRHR

HOCKEY GOAL TARGET

The Practice Partner hockey goal target is perfect for improving your shooting precision and accuracy. Heavy duty vinyl target with five target zones.

Practice Partner® Hockey Goal Target

RHTARGET



OFFICIAL VOLLEYBALL SYSTEM



Meets USVBA, NCAA, and NFHS competition specifications and is designed for any size budget. Posts adjust to Men's (7' 11^{5/8}"), Women's (7' 4^{1/8}"), and Junior's (7') net heights. The ratchet winch easily sets net tension and 5-point net attachment makes set-up quick and easy. Locking collar securely holds net in position. Bottom of uprights feature adjustable, non-marking pads. Upright safety pads included with choice of 14 different colors. Ships truck freight.

Complete Volleyball System **VBATS**

COMPLETE ONE-COURT SYSTEM INCLUDES:

- (1) 3.5" O.D. Upright
- (1) 3.5" O.D. Upright with Winch
- (2) 3.5" O.D. Floor Sleeves
- (2) Hinged Brass or Chrome Cover Plates
- (1) Collegiate Net with Tensioner
- (1) Pair of Antennas and Sideline Markers
- (2) Upright Safety Pads
- (1) Set of 4 Cable Covers

NET SYSTEMS

PRO VOLLEYBALL NET



3'1/8" x 32' long with 2.5" white headband & vinyl-coated steel cable at top & bottom. Black, 3.0mm knotless netting. Includes side pockets & dowels.

Pro Volleyball Net **VBNETP**

COLLEGIATE VOLLEYBALL NET



3' x 32' long with 2.5" white headband top only. Vinyl coated steel cable top & nylon roped bottom. Black, 2.6mm braided poly netting.

College Volleyball Net **VBNETC**

BASIC VOLLEYBALL NET



3' x 32' long with 2.5" white headband. Polyrope cable with taped sides & bottom. Black, 2.6mm braided poly netting.

Basic Volleyball Net **VBNETB**

UNIVERSAL REFEREE STAND

Sturdy yet lightweight. Works with any volleyball system. Front legs are removable to allow stand to be securely attached to volleyball post with V-bracket and velcro straps. Platform is 44" high with safety rails extending 34" above the platform. Two non-marring wheels allow for easy transport.

Optional padding available. Dense foam covered with reinforced vinyl. Hook and loop attachments.

Padding Available in: Red, Black, Maroon, Forest Green, Royal Blue, Navy Blue, and Purple.



Referee Stand **VRSTND**
Referee Stand Padding **VRPAD**



WEIGHTED ROLLAWAY STANDARDS

NEW
AND IMPROVED
DESIGN!



Features heavy-duty steel base powder-coated black with vinyl edge protection and non-marking wheels. Galvanized steel upright is 120" high and includes 2 slide rings for multiple net heights. Sold as pairs. Each base weighs 180 lbs. Ships truck freight.

24" Weighted Standard **VBSTD180**

FILLABLE ROLLAWAY STANDARDS



Features heavy-duty steel base with vinyl edge protection & non-marking wheels. Uprights are 8'6" plated steel & feature two multi-purpose ring slides that are height adjustable for multi-use. Base comes in 24" or 30" diameters that can be filled with sand or concrete for added weight. Ships truck freight.

24" Fillable Standard **VBSTD24**
30" Fillable Standard **VBSTD30**

TARGET CHALLENGER



12' adjustable pole height with 30" target ring. Includes 22 lb. weight for stability and non-marking wheels for easy mobility. Sturdy net collects balls for easy retrieval. Ideal for passing, setting, or shooting. **BALL CART SOLD SEPARATELY.**

Target Challenger **VBTARGET**

DELUXE BALL LOCKER



**PERFECT FOR
VOLLEYBALLS**

Full size locker holds 28-30 balls. Heavy steel wire mesh. Powder-coated for durability. Hinged lid can be locked. 4 HD swivel caster wheels.

Size: 42"L x 24"W x 38.5"H

HD Secure Ball Locker **BLOCK**

VERTICAL CHALLENGER



Telescopic pole adjusts from 4-12 feet high. Movable veins spaced 1" apart. Heavy duty base includes weight for stability and non-marking wheels for easy mobility. Includes reset pole.

Vertical Challenger **VBVERT**

SPORTS BANNERS

CHAMPIONSHIP BANNERS



Hang your championships from the rafters. Show fans, prospects, and players what your program has accomplished. [**CALL FOR CUSTOM PRICING.**](#)

POLE BANNERS

Extend your facility's branding into the parking lot and surrounding campus. Display star players, accomplishments, upcoming events, or your team's logo.

[**CALL FOR CUSTOM PRICING.**](#)



ACHIEVEMENT BANNERS



Display the records of the top individual performers through your team's history. Appliqué construction allows for easy future updates.

[**CALL FOR CUSTOM PRICING.**](#)

WINDOW AND WALL GRAPHICS

Take your facility to the next level with digitally printed vinyl wall graphics. Available in a wide range of materials depending on surface.

[**CALL FOR CUSTOM PRICING.**](#)



SPORTS FLAGS

CHAMPIONSHIP FLAGS



Take your facility to the next level with digitally printed vinyl wall graphics. Available in a wide range of materials depending on surface.

[**CALL FOR CUSTOM PRICING.**](#)

TEAM FLAGS



Flags with your team's brand elevate any sports facility. Leave players, fans, and passers by with no doubt who's facility they're looking at.

[**CALL FOR CUSTOM PRICING.**](#)

SPIRIT FLAGS



Give your cheerleaders the tools they need to stir up team spirit. Spirit flags of any size are sure to be a hit.

[**CALL FOR CUSTOM PRICING.**](#)

FEATHER FLAGS



Advertise upcoming events, recent accomplishments, and star players. Bring attention to entrances, exits, the box office, and other important areas.

[**CALL FOR CUSTOM PRICING.**](#)

BLEACHER ENCLOSURES

Cover the sides and back of your bleachers to provide a unique branding opportunity. Enclosures are custom made to your specifications.

INDOOR ENCLOSURES



Produced from 13 oz. soft-knit polyester, which comes white but is fully digitally printed to match your brand.

[CALL FOR CUSTOM PRICING.](#)

OUTDOOR ENCLOSURES



Constructed with 16 oz. ProMesh windscreen for durability and weather resistance. Can be printed with the design of your choice.

[CALL FOR CUSTOM PRICING.](#)

STADIUM SEAT COVERS



Enhance your stadium's look with color, texture, and even graphics! Block spectators from sitting in certain areas for specific events. Constructed of vinyl polyester mesh that is available in 13 colors.

Seat Covers are custom made to your specifications.

Color options:



[CALL FOR CUSTOM PRICING.](#)



STANDARD ALUMINUM BLEACHERS

STANDARD FEATURES:

- 2, 3, 4, 5, 8, & 10 Row Units
- 8' Rise/24' Run per Row
- 10' Seat Planks
- 17' Front Row Seat Height
- Available in 15', 21', and 27' Lengths
- Aluminum Frame
- Single Footboards on Rows 2 & 3
- Double Footboards & Risers on Rows 4 & Above
- Preferred Models Feature Double Foot Planks on ALL Rows

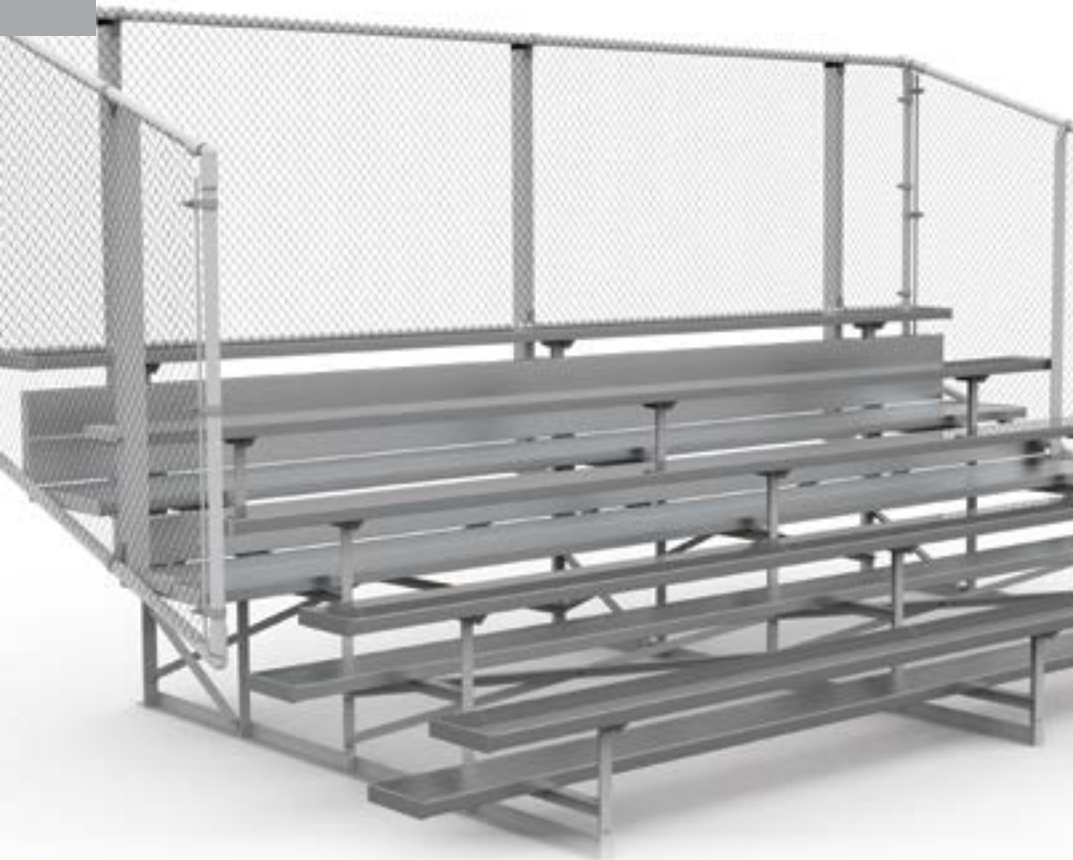

ITEM#	SEATS	ROWS	LENGTH	DEPTH	GUARD RAIL	PREFERRED MODEL
BL315S	30	3	15'	3'	N	BL315SD
BL321S	42	3	21'	3'	N	BL321SD
BL327S	54	3	27'	3'	N	BL327SD
BL415S	40	4	15'	7'	Y	BL415SD
BL421S	56	4	21'	7'	Y	BL421SD
BL427S	72	4	27'	7'	Y	BL427SD
BL515S	50	5	15'	9.5'	Y	BL515SD
BL521S	70	5	21'	9.5'	Y	BL521SD
BL527S	90	5	27'	9.5'	Y	BL527SD
BL815S	80	8	15'	15.2'	Y	BL815SD
BL821S	112	8	21'	15.2'	Y	BL821SD
BL827S	144	8	27'	15.2'	Y	BL827SD
BL1015S	100	10	15'	29.5'	Y	BL1015SD
BL1021S	140	10	21'	29.5'	Y	BL1021SD
BL1027S	180	10	27'	29.5'	Y	BL1027SD

ELEVATED BLEACHERS

PLEASE CALL WITH YOUR SPECIFICATIONS AND MEASUREMENTS FOR QUOTES ON ELEVATED ALUMINUM BLEACHERS!



LOW-RISE BLEACHERS



STANDARD FEATURES:

- 3 & 4 Row Units
- Aluminum Frame
- 6' Rise/24' Tread Depth
- Single Footboards
- 12' Seat Planks
- 12' Front Row Seat Height
- Preferred Models Feature Double Foot Planks on ALL Rows

ITEM#	SEATS	ROWS	LENGTH	DEPTH	HEIGHT	PREFERRED MODEL
BL315LR	30	3	15'	5'	22.5"	BL315LRD
BL321LR	42	3	21'	5'	22.5"	BL321LRD
BL415LR	40	4	15'	7'	28.5"	BL415LRD
BL421LR	56	4	21'	7'	28.5"	BL421LRD
BL427LR	72	4	27'	7'	28.5"	BL427LRD

TIP & ROLL BLEACHERS

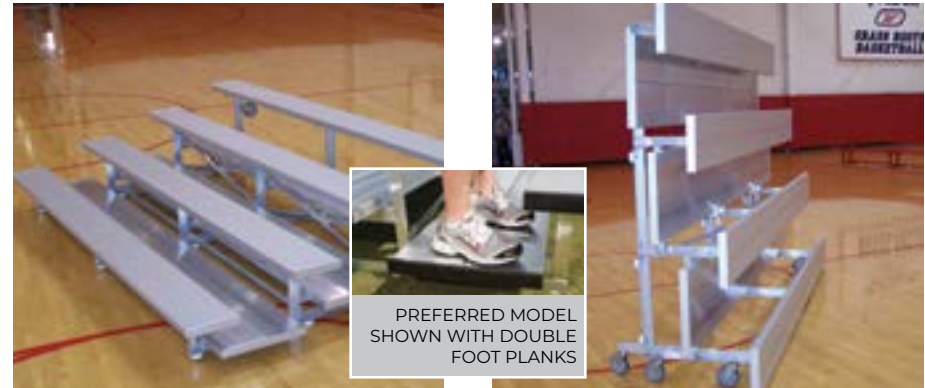

STANDARD FEATURES:

- Rubber foot pads to protect floors
- Aluminum angle frames for easier tipping
- 6' Rise/24" Tread Depth
- 2' x 10" Anodized Seat Planks (2" x 12" on 4-row model)
- 2' x 10" Mill Finished Foot Planks
- 5" Locking Swivel Caster Wheels for easy rolling
- Preferred Models Feature Double Foot Planks on ALL Rows

ITEM#	SEATS	ROWS	LENGTH	DEPTH	HEIGHT	PREFERRED MODEL
BL27.5TR	10	2	7.5'	36"	36"	BL27.5TRD
BL215TR	20	2	15'	36"	36"	BL215TRD
BL221TR	28	2	21'	36"	36"	BL221TRD
BL37.5TR	15	3	7.5'	36"	36"	BL37.5TRD
BL315TR	30	3	15'	60"	60"	BL315TRD
BL321TR	42	3	21'	60"	60"	BL321TRD
BL47.5TR	20	4	7.5'	84"	84"	BL47.5TRD
BL415TR	40	4	15'	84"	84"	BL415TRD

ADDITIONAL MATERIAL SURCHARGES MAY APPLY

SUPREME SERIES BLEACHERS



STANDARD FEATURES:

- 4, 5, 8, & 10 Row Units
- Double Footboards & Risers on ALL Rows
- 8' Rise/24' Tread per Row
- Aisle with Anodized Handrails
- 10' Seat Planks
- Aluminum Frame
- 17' Front Row Seat Height
- Chainlink Guardrail

INSTALLATION AVAILABLE - CALL FOR DETAILS

ITEM#	SEATS	ROWS	LENGTH	DEPTH
BL421SP	50	4	21'	7'-0"
BL427SP	66	4	27'	7'-0"
BL515SP	42	5	15'	9'-5"
BL521SP	58	5	21'	9'-5"
BL527SP	74	5	27'	9'-5"
BL815SP	66	8	15'	15'-2"
BL821SP	91	8	21'	15'-2"
BL827SP	116	8	27'	15'-2"
BL1015SP	82	10	15'	29'-5"
BL1021SP	113	10	21'	29'-5"
BL1027SP	144	10	27'	29'-5"
BL1030SP	164	10	30'	29'-5"

ADA COMPLIANT BLEACHERS

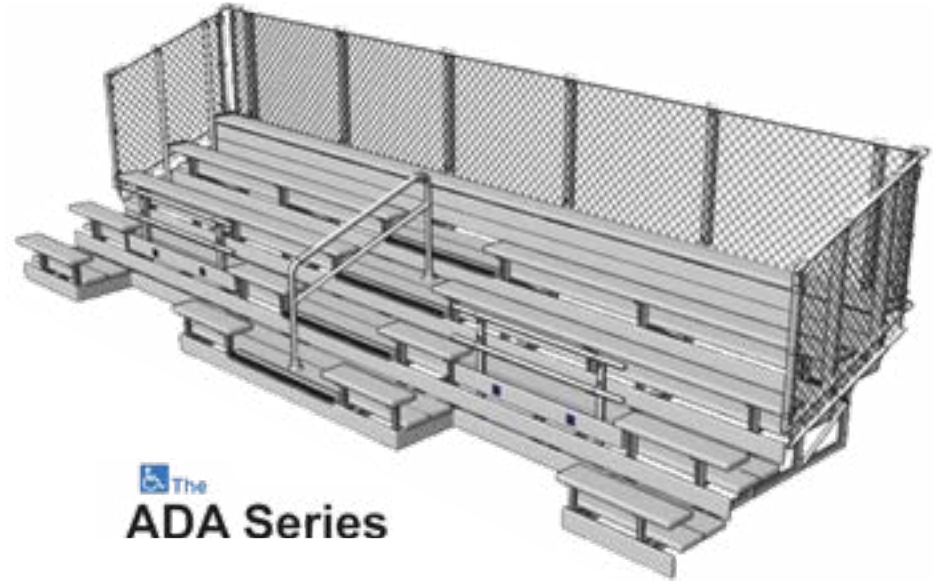

STANDARD FEATURES:

- 5 Row Units
- Double Footboards & Risers on ALL Rows
- 8' Rise/24' Tread per Row
- Aisle with Anodized Handrails
- 10' Seat Planks
- Aluminum Frame
- Chainlink Guardrail
- Open First Row Wheelchair Accessible Area
- Meets Code Including ADA Seating

ITEM#	SEATS	LENGTH	DEPTH
BL515HC	34+2 HC	15'	9' 5"
BL519.5HC	45+2 HC	19' 6"	9' 5"
BL521HC	48+2 HC	21'	9' 5"
BL527HC	58+4 HC	27'	9' 5"

ALUMINUM TEAM BENCHES



ALL ALUMINUM
BENCH WITH
BACK & SHELF



IN-GROUND
MOUNT



PORTABLE



SURFACE
MOUNT

Heavy-duty player's benches featuring anodized aluminum seat planks and optional anodized backrests. The galvanized legs are a heavy 23/8" O.D. pipe built for maximum strength. Legs are all aluminum for no rust and extreme durability.

ITEM#	DESCRIPTION	MOUNT TYPE	FRAME TYPE	WEIGHT
PBO8PB	8' Bench with Back	Portable	Galvanized Steel	135 lbs
PB08P	8' Bench without Back	Portable	Galvanized Steel	66 lbs
PBO8SM	8' Bench without Back	Surface Mount	Galvanized Steel	59 lbs
PB08SMB	8' Bench with Back	Surface Mount	Galvanized Steel	95 lbs
PB08IG	8' Bench without Back	In-Ground Mount	Galvanized Steel	62 lbs
PB08IGB	8' Bench with Back	In-Ground Mount	Galvanized Steel	102 lbs
PBS08	8' Bench with Back & Shelf	Surface/Portable	Aluminum	135 lbs
PB15PB	15' Bench with Back	Portable	Galvanized Steel	187 lbs
PB15P	15' Bench without Back	Portable	Galvanized Steel	92 lbs
PB15SM	15' Bench without Back	Surface Mount	Galvanized Steel	81 lbs
PB15SMB	15' Bench with Back	Surface Mount	Galvanized Steel	143 lbs
PB15IG	15' Bench without Back	In-Ground Mount	Galvanized Steel	85 lbs
PB15IGB	15' Bench with Back	In-Ground Mount	Galvanized Steel	150 lbs
PBS15	15' Bench with Back & Shelf	Surface/Portable	Aluminum	198 lbs
PB21PB	21' Bench with Back	Portable	Galvanized Steel	261 lbs
PB21P	21' Bench without Back	Portable	Galvanized Steel	140 lbs
PB21SM	21' Bench without Back	Surface Mount	Galvanized Steel	126 lbs
PB21SMB	21' Bench with Back	Surface Mount	Galvanized Steel	211 lbs
PB21IG	21' Bench without Back	In-Ground Mount	Galvanized Steel	132 lbs
PB21IGB	21' Bench with Back	In-Ground Mount	Galvanized Steel	220 lbs
PBS21	21' Bench with Back & Shelf	Surface/Portable	Aluminum	279 lbs

488 CUMBERLAND STREET

MEMPHIS, TN 38112

trigonsports.com • 888-313-1303



Are you interested in becoming a
TEAM DEALER?

CONTACT US:

888-313-1303 • sales@trigonsports.com

MAKE WINNING POSSIBLE.®

**VISIT TRIGONSPORTS.COM
FOR CURRENT PRICING**