



FIELD HOCKEY

2024

DIGITAL CATALOG

UNIFORMS.ADICUSTOM.COM CUSTOMIZE YOUR LOOK

TEAM NAME

LOUISVILLE

ADIDAS LOGO



NUMBERS

3

LOUISVILLE
FRONT &
BACK 8



TEAM COLORS



FABRICS

14 CLOTH: STRETCH KNIT
87 CLOTH: ADI MESH

TEAM LOGOS





INDEX

2024 / FIELD HOCKEY

UNIFORMS
STYLES 4

REFERENCE
FIELD HOCKEY 13



UNIFORMS

2024 / FIELD HOCKEY



GO TO UNIFORMS.ADICUSTOM.COM TO CREATE YOUR LOOK



PROSPECT

2024 / FIELD HOCKEY

PROSPECT JERSEY

W AD04645W - RACERBACK

W AD04640W - SHORT SLEEVE

MSRP \$100.00

SUBLIMATED /// SIZES XS-2XL

W AD04643W - LONG SLEEVE

MSRP \$115.00

SUBLIMATED /// SIZES XS-2XL

Body - 14 and 87 Cloth in different zones

JERSEY CUT OPTIONS



RACERBACK

SHORT SLEEVE

LONG SLEEVE

PROSPECT BOTTOM

W AD04641W - SHORT

W AD04642W - KILT

MSRP \$90.00

SUBLIMATED /// SIZES XS-2XL

Body - 14 and 87 Cloth in different zones

Short Inseam: 5"

Kilt Outseam: 14"

BOTTOM CUT OPTIONS

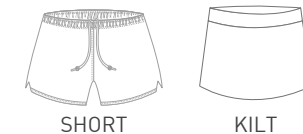

SHORT

KILT



GO TO UNIFORMS.ADICUSTOM.COM TO CREATE YOUR LOOK



FINALIZER JERSEY

W AD04646W - RACERBACK

W AD04637W - SHORT SLEEVE

MSRP \$100.00

SUBLIMATED /// SIZES XS-2XL

W AD04644W - LONG SLEEVE

MSRP \$115.00

SUBLIMATED /// SIZES XS-2XL

Body - 14 and 87 Cloth in different zones

JERSEY CUT OPTIONS



RACERBACK



SHORT SLEEVE



LONG SLEEVE



FINALIZER BOTTOM

W AD04638W - SHORT

W AD04639W - KILT

MSRP \$90.00

SUBLIMATED /// SIZES XS-2XL

Body - 14 and 87 Cloth in different zones

Short Inseam: 5"

Kilt Outseam: 14"

BOTTOM CUT OPTIONS



SHORT

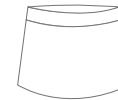

KILT

FINALIZER



GO TO UNIFORMS.ADICUSTOM.COM TO CREATE YOUR LOOK



BLUE CHIP JERSEY

W AD04630W - RACERBACK

W AD04628W - SHORT SLEEVE

MSRP \$100.00

SUBLIMATED /// SIZES XS-2XL

W AD04626W - LONG SLEEVE

MSRP \$115.00

SUBLIMATED /// SIZES XS-2XL

Body - 14 and 87 Cloth in different zones

JERSEY CUT OPTIONS



RACERBACK



SHORT SLEEVE



LONG SLEEVE



BLUE CHIP BOTTOM

W AD04634W - SHORT

W AD04636W - KILT

MSRP \$90.00

SUBLIMATED /// SIZES XS-2XL

Body - 14 and 87 Cloth in different zones

Short Inseam: 5"

Kilt Outseam: 14"

BOTTOM CUT OPTIONS



SHORT

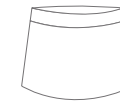

KILT

BLUE CHIP



GO TO UNIFORMS.ADICUSTOM.COM TO CREATE YOUR LOOK

SHOWCASE



SHOWCASE JERSEY

- W AD04629W - RACERBACK
- W AD04631W - SLEEVELESS
- W AD04627W - SHORT SLEEVE

MSRP \$100.00

SUBLIMATED /// SIZES XS-2XL

- W AD04625W - LONG SLEEVE

MSRP \$115.00

SUBLIMATED /// SIZES XS-2XL

Body - 14 and 87 Cloth in different zones

JERSEY CUT OPTIONS



SHOWCASE BOTTOM

- W AD04633W - SHORT
- W AD04635W - KILT

MSRP \$90.00

SUBLIMATED /// SIZES XS-2XL

Body - 14 and 87 Cloth in different zones

Short Inseam: 5"
Kilt Outseam: 14"

BOTTOM CUT OPTIONS

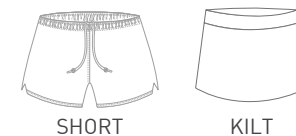



GO TO UNIFORMS.ADICUSTOM.COM TO CREATE YOUR LOOK



IROQUOIS JERSEY

- W AD04604W - RACERBACK
- W AD04604W - SLEEVELESS
- W AD04604W - SHORT SLEEVE
- W AD04604W - LONG SLEEVE

MSRP \$103.00

SUBLIMATED /// SIZES XS-2XL

Body - 14 Cloth

JERSEY CUT OPTIONS



IROQUOIS BOTTOM

- W AD04614W - SHORT
- W AD04614W - KILT

MSRP \$90.00

SUBLIMATED /// SIZES XS-2XL

Body - 14 Cloth
Short Inseam: 5"
Kilt Outseam: 14"

BOTTOM CUT OPTIONS

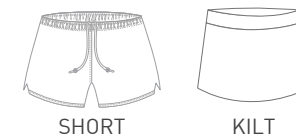

IROQUOIS



GO TO UNIFORMS.ADICUSTOM.COM TO CREATE YOUR LOOK



SENECA JERSEY

- AD04605W - RACERBACK**
- AD04605W - SLEEVELESS**
- AD04605W - SHORT SLEEVE**
- AD04605W - LONG SLEEVE**

MSRP \$103.00

SUBLIMATED /// SIZES XS-2XL

Body - 14 Cloth

JERSEY CUT OPTIONS



SENECA BOTTOM

- AD04615W - SHORT**
- AD04615W - KILT**

MSRP \$90.00

SUBLIMATED /// SIZES XS-2XL

Body - 14 Cloth
Short Inseam: 5"
Kilt Outseam: 14"

BOTTOM CUT OPTIONS

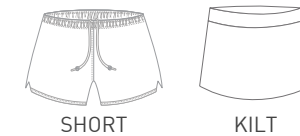

SENECA



GO TO UNIFORMS.ADICUSTOM.COM TO CREATE YOUR LOOK



FINALIZER REVERSIBLE JERSEY

W AD04583W - PINNIE

MSRP \$85.00

SUBLIMATED /// SIZES XS-2XL

Body - 29 Cloth

FINALIZER SHORT

W AD04584W - SHORT

MSRP \$80.00

SUBLIMATED /// SIZES XS-2XL

Body - 29 Cloth
Short Inseam: 5"
Kilt Outseam: 14"



FINALIZER



GO TO UNIFORMS.ADICUSTOM.COM TO CREATE YOUR LOOK



CLUB PINNIE

W AD04592W - PINNIE

MSRP \$73.00

SUBLIMATED /// SIZES XS-XL

Body - 29 Cloth

CLUB SHORT

W AD04593W - KILT

MSRP \$60.00

SUBLIMATED /// SIZES XS-XL

Body - 29 Cloth

Kilt Outseam: 14"



CLUB



REFERENCE

2024 / FIELD HOCKEY

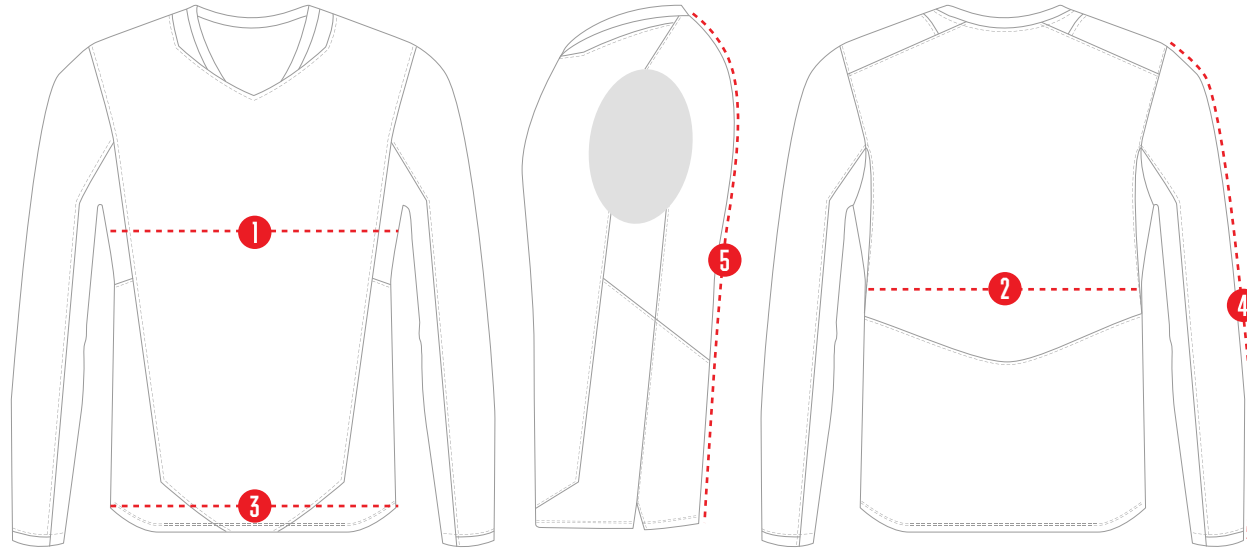

LONG SLEEVE
BLUE CHIP AD04626W

		TOLERANCE	XS	S	M	L	XL	2XL
1	CHEST	3/4	33 1/4	35 1/4	37 1/4	39 3/4	42 1/4	44 3/4
2	WAIST WIDTH	3/4	30 3/4	32 3/4	34 3/4	37 1/4	39 3/4	42 1/4
3	HEM OPENING/SWEEP	3/4	34 5/8	36 5/8	38 5/8	41 1/8	43 5/8	46 1/8
4	SLEEVE LENGTH	1/2	23 3/8	24 1/8	24 5/8	25 1/4	25 7/8	26 1/2
5	BACK LENGTH - FROM CENTER BACK NECK	1/2	24 5/8	25 1/8	25 5/8	26	26 1/2	26 7/8

*All measurements are in inches.

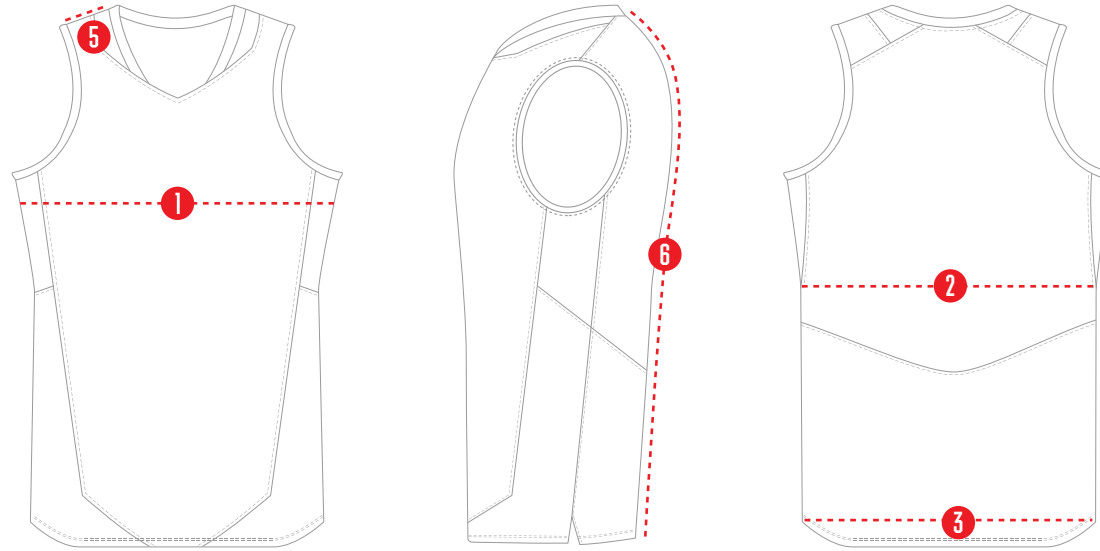

RACERBACK
BLUE CHIP AD04630W

		TOLERANCE	XS	S	M	L	XL	2XL
1	CHEST	3/4	33	35	37	39 1/2	42	44 1/2
2	WAIST WIDTH - NARROWEST POINT	3/4	30	32	34	36 3/8	39	41 3/8
3	HEM OPENING/SWEEP	3/4	34 3/4	36 3/4	38 3/4	41 1/4	43 3/4	46 1/4
4	SHOULDER WIDTH - STANDARD	1/8	2 1/2	2 5/8	2 3/4	2 3/4	2 7/8	2 7/8
5	SHOULDER WIDTH - RACERBACK	1/8	2 5/8	2 5/8	2 3/4	2 3/4	2 3/4	2 7/8
6	BACK LENGTH - CENTER BACK NECK	1/2	24 5/8	25 1/8	25 5/8	26 1/8	26 5/8	27 1/8

*All measurements are in inches.

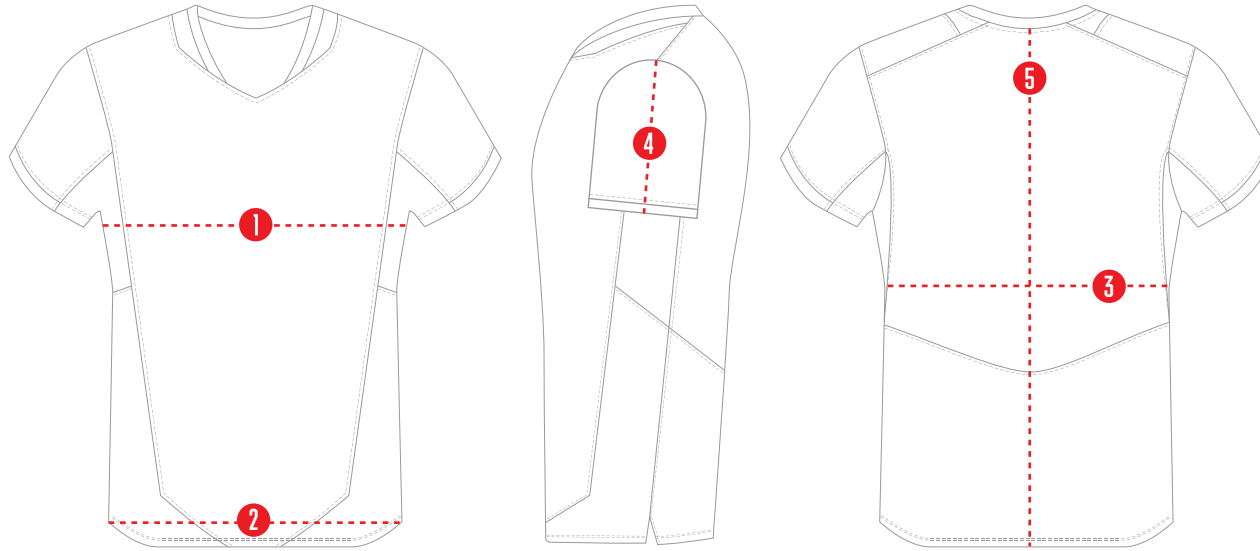

SHORT SLEEVE
BLUE CHIP AD04628W

		TOLERANCE	XS	S	M	L	XL	2XL	3XL
1	CHEST	3/4	33 1/4	35 1/4	37 1/4	39 3/4	42 1/4	44 3/4	47 1/4
2	WAIST WIDTH/SWEEP	3/4	34 7/8	36 7/8	38 7/8	41 3/8	43 7/8	46 3/8	48 7/8
3	WAIST WIDTH NARROWEST POINT	3/4	30 3/4	32 3/4	34 3/4	37 1/4	39 3/4	42 1/4	44 3/4
4	SLEEVE LENGTH	1/4	7 1/4	7 3/8	7 3/8	7 3/8	7 3/8	7 7/16	5 7/8
5	BACK LENGTH - FROM CENTER BACK NECK	1/2	24 5/8	25 1/8	25 5/8	26	26 1/2	26 7/8	27 3/8

*All measurements are in inches.

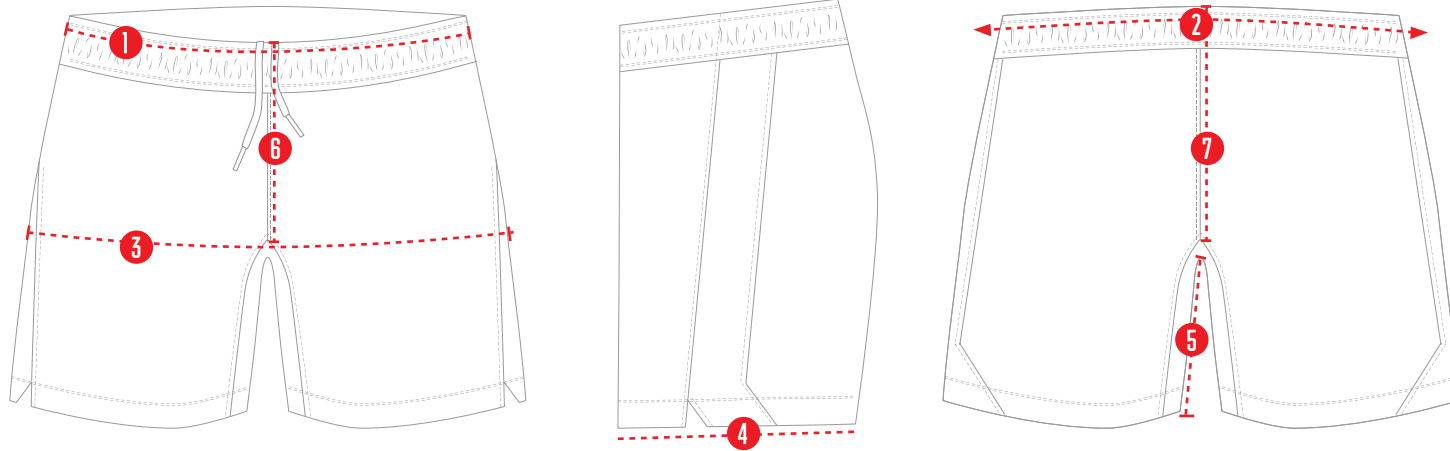

SHORT
BLUE CHIP AD04634W

		TOLERANCE	XS	S	M	L	XL	2XL	3XL
1	WAIST RELAXED	3/4	26	28	30	32	34	36	38
2	WAIST STRETCHED	3/4	36 7/8	38 7/8	40 7/8	42 7/8	44 7/8	46 3/4	48 3/4
3	HIP WIDTH	3/4	38 1/2	40 1/2	42 1/2	44 1/2	46 5/8	48 5/8	50 3/4
4	LEG OPENING	1/2	23 5/8	24 5/8	25 5/8	26 5/8	27 5/8	28 5/8	29 5/8
5	INSEAM	1/4	5	5	5	5	5	5	5
6	FRONT RISE	3/8	10	10 1/2	11	11 1/2	12	12 1/2	13
7	BACK RISE	3/8	12	12 1/2	13	13 1/2	14	14 1/2	15

*All measurements are in inches.

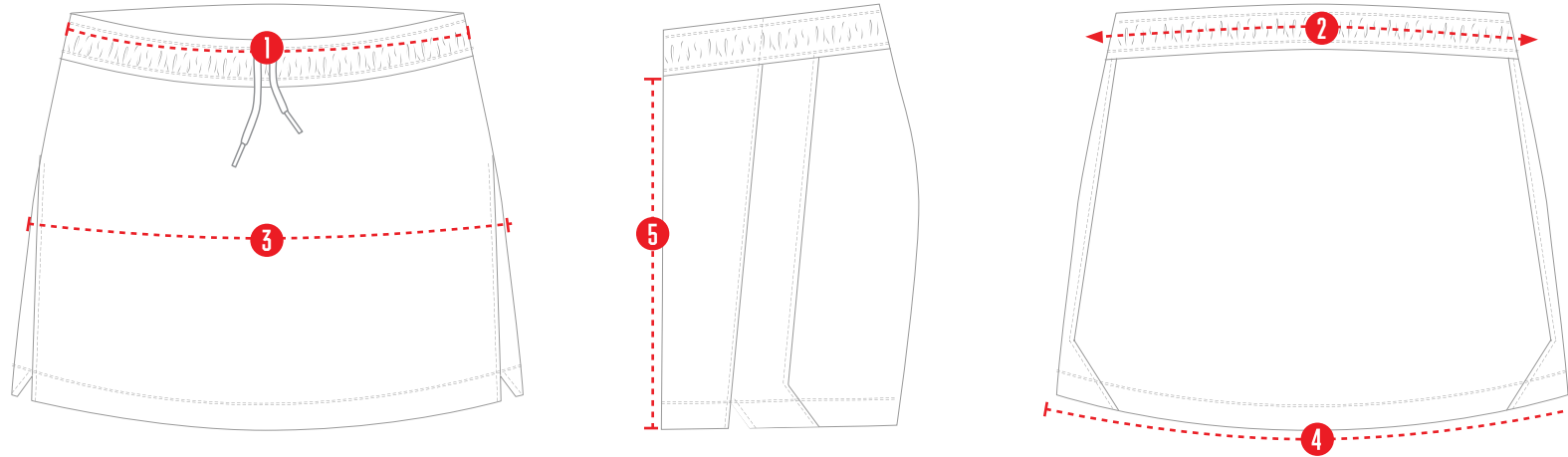

KILT
BLUE CHIP AD04636W

		TOLERANCE	XS	S	M	L	XL	2XL	3XL
1	WAIST RELAXED	3/4	27 1/2	29 1/2	31 1/2	33 1/2	35 1/2	37 1/2	39 1/2
2	WAIST STRETCHED	3/4	33 1/8	35 1/8	37 1/8	39 1/4	41 1/4	43 1/4	45 1/4
3	HIP WIDTH	3/4	36 3/4	38 3/4	40 3/4	42 3/4	44 3/4	46 3/4	48 3/4
4	HEM OPENING - ALONG CURVE	3/4	43 7/8	45 7/8	48	50	52	54	56
5	FRONT LENGTH EXCLUDING WAIST BAND	1/2	10 5/8	11 1/4	11 3/4	12 1/4	12 3/4	13 1/4	13 3/4

*All measurements are in inches.

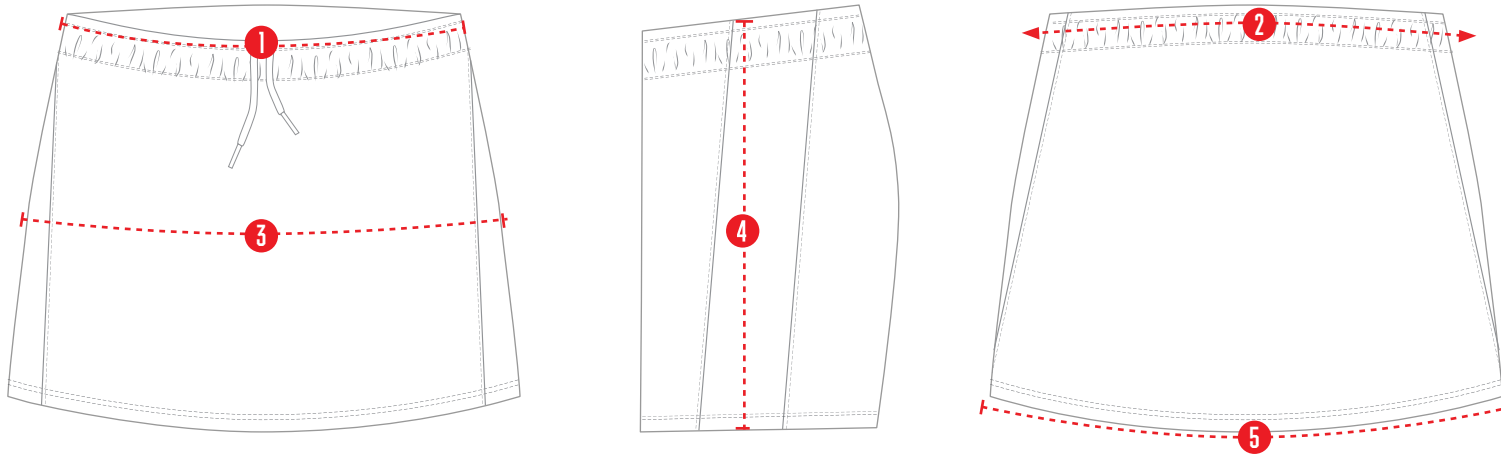

KILT

PROSPECT AD04642W

		TOLERANCE	XS	S	M	L	XL	2XL
1	WAIST RELAXED	3/4	28 1/2	30 1/2	32 1/2	34 1/2	36 1/2	38 1/2
2	WAIST STRETCHED	3/4	31 1/2	33 1/2	35 1/2	37 1/2	39 1/2	41 1/2
3	HIP WIDTH	3/4	37 5/8	39 3/4	41 3/4	43 7/8	45 7/8	48
4	SIDE LENGTH	1/2	14 1/8	14 5/8	15 1/8	15 5/8	16 1/8	16 5/8
5	HEM WIDTH	3/4	46 1/2	48 1/2	50 1/2	52 1/2	54 1/2	56 3/8

*All measurements are in inches.

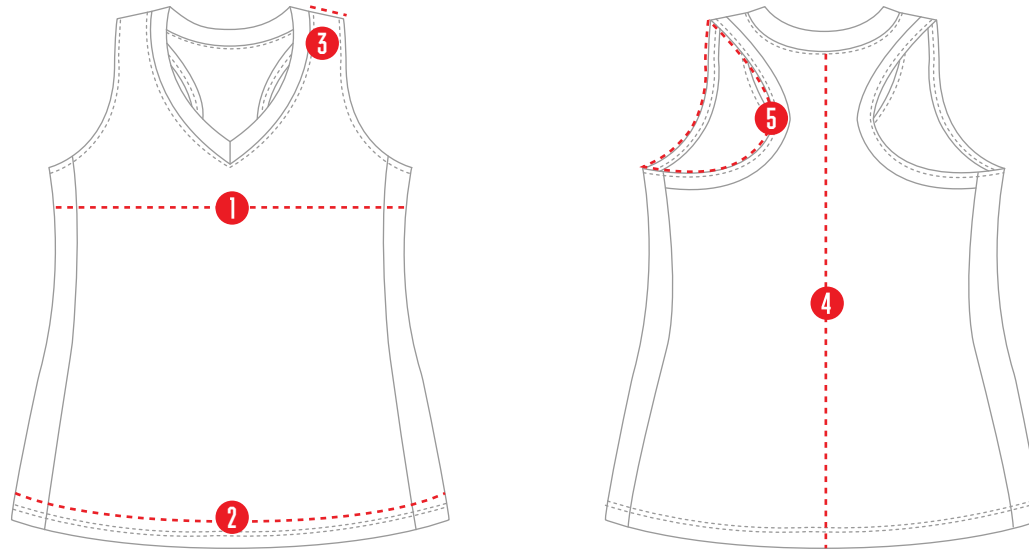

RACERBACK

IROQUOIS AD04604W

		TOLERANCE	XS	S	M	L	XL	2XL
1	CHEST - 1" BELOW	3/4	32 1/8	34 1/8	36 1/8	38 5/8	41 1/8	43 5/8
2	WAIST WIDTH/SWEEP	3/4	36 1/4	38 1/4	40 1/4	42 3/4	45 1/4	47 3/4
3	SHOULDER LENGTH	1/8	1 1/2	1 1/2	1 1/2	1 1/2	1 1/2	1 1/2
4	LENGTH FROM CENTER BACK NECK	1/2	21 3/8	21 7/8	22 3/8	22 7/8	23 3/8	23 7/8
5	ARM HOLE CIRCUMFERENCE ALONG EDGE	1/2	21 1/2	22 5/8	23 7/8	25 3/8	26 7/8	28 1/2

*All measurements are in inches.

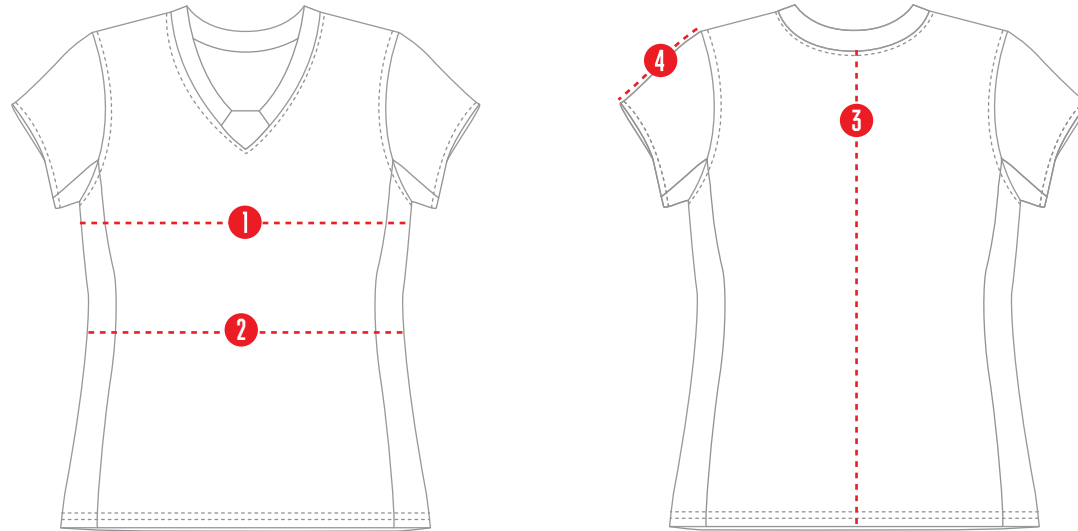

SHORT SLEEVE

IROQUOIS AD04604W

		TOLERANCE	XS	S	M	L	XL	2XL
1	CHEST - 1" BELOW	3/4	30 3/4	32 3/4	34 3/4	37 1/4	39 3/4	42 1/4
2	WAIST WIDTH	3/4	28 1/2	30 1/2	32 1/2	35	37 1/2	40
3	LENGTH FROM CENTER BACK NECK	1/2	24	24 1/2	25	25 3/8	25 7/8	26 1/4
4	SLEEVE LENGTH - SHORT SLEEVE	3/8	8 1/4	8 1/4	8 1/4	8 1/4	8 1/4	8 1/4
5	SLEEVE LENGTH - LONG SLEEVE	3/8	22 3/4	23 1/2	24 1/8	24 3/4	25 3/8	26
6	SLEEVE LENGTH - CAP SLEEVE	1/4	5 3/8	5 3/8	5 3/8	5 3/8	5 3/8	5 3/8

*All measurements are in inches.

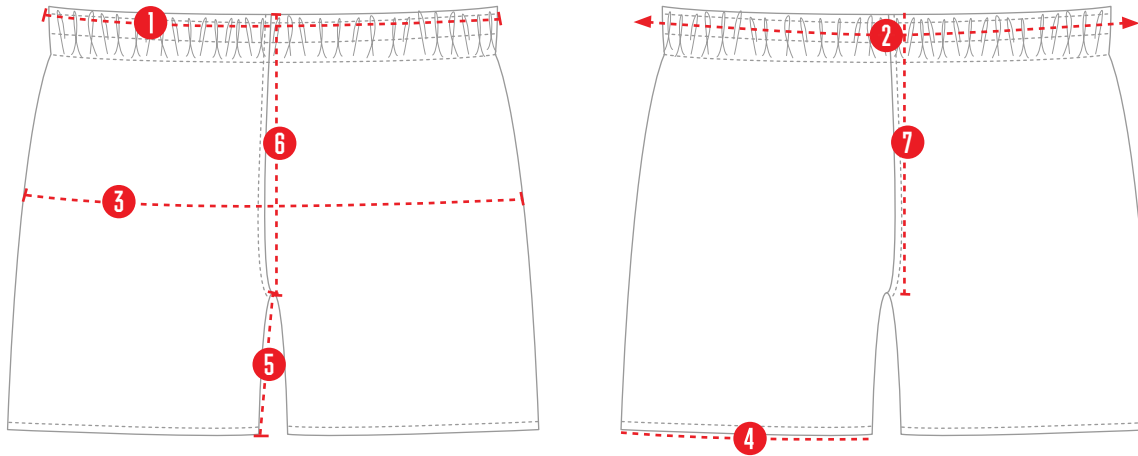

SHORT

IROQUOIS AD04614W

		TOLERANCE	XS	S	M	L	XL	2XL
1	WAIST WIDTH RELAXED	3/4	24	26	28	30	32	34
2	WASIT WIDTH STRETCHED	3/4	33	35	37	39	41	43
3	HIP WIDTH	3/4	38	40	42	44	46	48
4	LEG OPENING	1/2	21 3/4	22 3/4	23 3/4	24 3/4	25 3/4	26 3/4
5	INSEAM	3/8	5	5	5	5	5	5
6	FRONT RISE	3/8	9 3/4	10 1/4	10 3/4	11 1/4	11 3/4	12 1/4
7	BACK RISE	3/8	12 3/4	13 1/4	13 3/4	14 1/4	14 3/4	15 1/4

*All measurements are in inches.

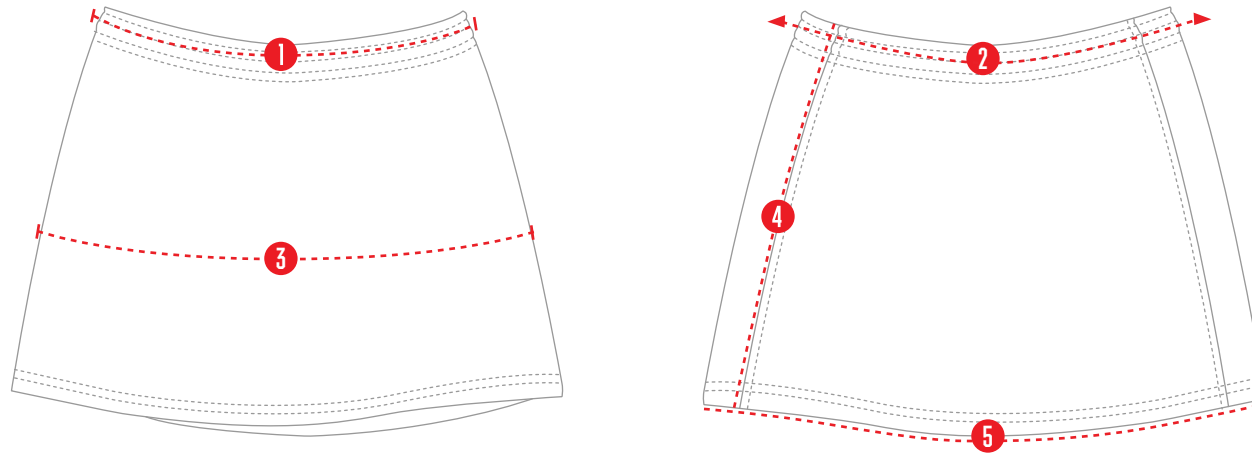

KILT

IROQUOIS AD04614W

		TOLERANCE	XS	S	M	L	XL	2XL
1	WAIST RELAXED	3/4	24	26	28	30	32	34
2	WAIST STRETCHED	3/4	33	35	37	39	41	43
3	HIP WIDTH	3/4	35 1/2	37 1/2	39 1/2	41 1/2	43 1/2	45 1/2
4	SIDE SEAM LENGTH	1/2	13	13 1/2	14	14 1/2	15	15 1/2
5	HEM OPENING CIRCUMFERENCE	1/2	42	44	46	48	50	52

*All measurements are in inches.

FIELD HOCKEY REFERENCE

COLOR OPTIONS BY FABRIC SELECTION

SUBLIMATION OPTIONS

		Team White	Team Black	Dark Brown	Team Navy Blue	Team Coll Burgundy	Team Coll Gold	Collegiate Orange	Team Coll Purple	Team Royal Blue	Dark Green	Team Green	Team Light Blue	Team Mid Grey	Team Maroon	Team Dark Grey	Team Power Red	Team Sand	
14 Stretch Knit																			
29 Double Sided Mesh																			
87 adi 3 Mesh																			

SEE SUBLIMATION COLORS

CLOTH OPTIONS BY STYLE

GAME UNIFORMS

14 **87**

REVERSIBLE & CLUB UNIFORM

29

SUBLIMATED COLOR OPTIONS

Team Black 095A	Team Dark Grey ADFD	Team Mid Grey ADFC	Team Light Gray ADFE	Dark Brown 247A	Team Sand ADF4	Cream
Team Coll Purple ADF2	Team Maroon ADEY	Team Coll Burgundy ADEZ	Team Victory Red ADFX	Team Power Red ADF1	Collegiate Orange 34F0	Team Shock Pink ADFF
Diva Pink 307A	Lt. Orange 23F0	Team Coll Gold ADF6	Team Yellow ADF7	Team Solar Yellow ADFN	Dark Green AOQE	Team Green ADCZ
Bold Aqua A0U1	Coll Aqua 29F0	Team Navy Blue AD8Q	Team Royal Blue AD8R	Bright Royal 56F0	Team Lt. Blue ADA3	Team White 001A

FIELD HOCKEY REFERENCE

SUBLIMATED PRINT OPTIONS

SUBLIMATED BLACK ICE (Choose 1 or 2 Colors)



SUBLIMATED PRINT OPTIONS

SUBLIMATED SHOCKENERGY (Choose 2 or 3 Colors)



FIELD HOCKEY REFERENCE

SUBLIMATED PRINT OPTIONS

SUBLIMATED SHOCKWAVE (Choose 1 or 2 Colors)



SUBLIMATED PRINT OPTIONS

SUBLIMATED HEATHER (Choose 1 Color)

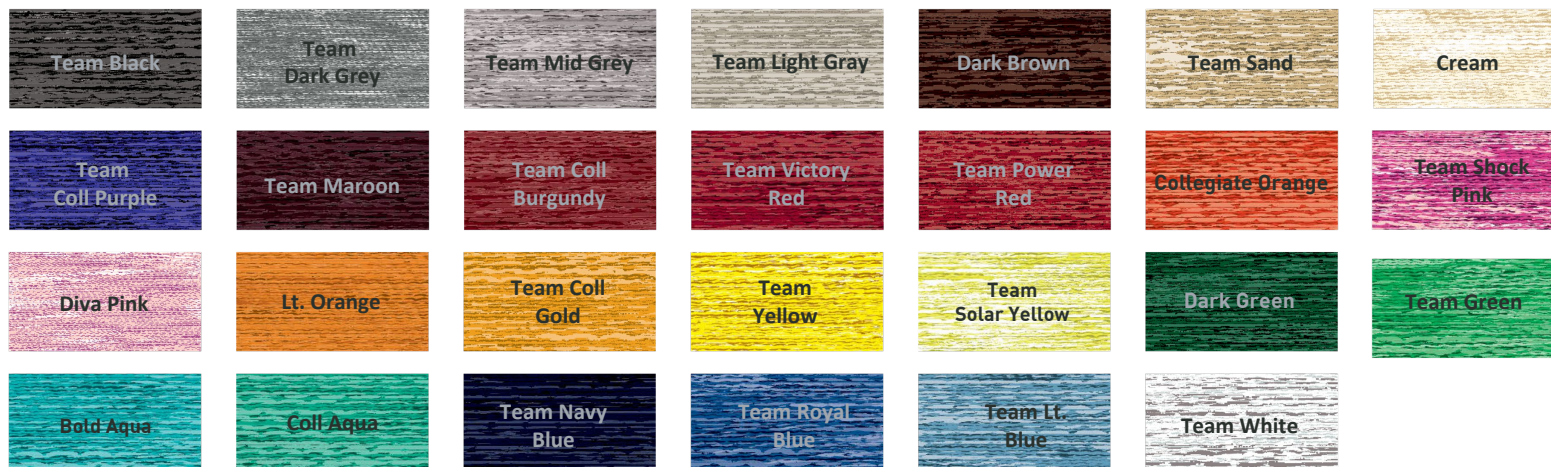

PRICING:

OTHER

Jersey - Alteration: +2; +4

MSRP: \$7.00
per 2" increment
MSRP: \$10.00

Sublimated Player Names
(Direct to Garment)

MINIMUMS

New Orders

Game Uniforms

12 units

Fill In Orders

5 units

Fill In Orders <5 units

100% upcharge

FIELD HOCKEY REFERENCE

ALPHA / NUMERIC FONTS

DRIBBLER	ABCDEFGHIJKLMNOPQRSTUVWXYZ	0 1 2 3 4 5 6 7 8 9
FALCONS	ABCDEFGHIJKLMNOPQRSTUVWXYZ	0 1 2 3 4 5 6 7 8 9
HAWKS	ABCDEFGHIJKLMNOPQRSTUVWXYZ	0 1 2 3 4 5 6 7 8 9
HEAT	ABCDEFGHIJKLMNOPQRSTUVWXYZ	0 1 2 3 4 5 6 7 8 9
INVADER	ABCDEFGHIJKLMNOPQRSTUVWXYZ	0 1 2 3 4 5 6 7 8 9
KNIGHTS	ABCDEFGHIJKLMNOPQRSTUVWXYZ	0 1 2 3 4 5 6 7 8 9
LIGHTNING	ABCDEFGHIJKLMNOPQRSTUVWXYZ	0 1 2 3 4 5 6 7 8 9
LOUISVILLE	ABCDEFGHIJKLMNOPQRSTUVWXYZ	0 1 2 3 4 5 6 7 8 9
NETS	ABCDEFGHIJKLMNOPQRSTUVWXYZ	0 1 2 3 4 5 6 7 8 9
PLAIN BLOCK	ABCDEFGHIJKLMNOPQRSTUVWXYZ	0 1 2 3 4 5 6 7 8 9
ROADRUNNER	ABCDEFGHIJKLMNOPQRSTUVWXYZ	0 1 2 3 4 5 6 7 8 9
THUNDERBIRDS	ABCDEFGHIJKLMNOPQRSTUVWXYZ	0 1 2 3 4 5 6 7 8 9
TIMES BOLD	ABCDEFGHIJKLMNOPQRSTUVWXYZ	0 1 2 3 4 5 6 7 8 9

ALPHA ONLY FONTS

BRUSH SCRIPT	<i>ABCDEFGHIJKLMNOPQRSTUVWXYZ abcdefghijklmnopqrstuvwxyz</i>
FULL BLOCK	ABCDEFGHIJKLMNOPQRSTUVWXYZ
LAKERS	ABCDEFGHIJKLMNOPQRSTUVWXYZ
OUTLINE FANCY BLOCK	ABCDEFGHIJKLMNOPQRSTUVWXYZ

NUMERIC ONLY FONTS

ALL STATE	0 1 2 3 4 5 6 7 8 9
PRO FULL BLOCK	0 1 2 3 4 5 6 7 8 9

ARC STYLES



FABRICS



Stretch Knit
White: 100% Poly



Double Sided Mesh
White: 100% Poly



adi 3 Mesh
Colors: 92% Nylon / 8% Spandex
White: 92% Poly / 8% Spandex

IMPORTANT: PRODUCT CARE INSTRUCTIONS

CUSTOM UNIFORM CARE INSTRUCTIONS:

To enhance the appearance and extend the life of your uniforms, adidas recommends that you follow these cleaning and storing procedures:

- Do not dry clean.
- Do not wash in hot water.
- Do not use chlorine bleach.
- Do not use fabric softener.
- Do not wash whites and colors together.
- Do not overload the washing machine.
- Do not machine dry on high heat.
- Do not leave wet or damp garments in your travel bag, in a pile with other clothing or in washing machine.
- Before using uniforms for the very first time, it is recommended that they be washed in cold water and hung to dry or machine dried on the lowest setting.
- Uniforms should always be laundered immediately after wearing.
 - However, if this is not possible, rinse garments and hang individually on rust-proof hangers (Moisture may cause color migration of acid dyes so we advise separating wet or damp uniforms.)
- Belts and any other contrasting color items should be washed separately from the garment.
- It is always advisable to test wash a single uniform according to directions before washing an entire load.
- We recommend presoaking heavily soiled garments in cold water with a protein release agent.
 - Follow the instructions recommended by the presoak manufacturer.
 - Wash garments immediately following the presoak in the normal wash cycle.
- Wash and rinse all garments in cold water with mild detergent.
 - Remove promptly after wash cycle to avoid color migration.
- For optimum results, hang garments (especially those with Spandex) to dry.
 - If you cannot hang dry, machine dry on the lowest setting.
 - Turn jerseys inside out before machine drying.
 - Remove items from dryer immediately upon completion of cycle.
 - Excessive heat can cause fabric shrinkage discoloration, and cracking and peeling of vinyl pastisol lettering inks.
- Make sure uniforms are completely dry before storing.
 - Store in a dry area to prevent mildew.
 - Protect them from sunlight and fluorescent light to prevent yellowing.

PLEASE NOTE:

adidas will not be responsible for uniforms that are damaged due to improper care and maintenance. Failure to follow our specified care instructions will void all guarantees.